

Additive Manufacturing



Heat Treatment of Additive Manufactured Parts

Retort Furnaces
Chamber Furnaces
Forced Convection Furnaces
Annealing Furnaces
Protective Gas Boxes
Furnaces for Debinding
Sintering Furnaces
High-Temperature Furnaces
Ovens
Chamber Ovens

www.nabertherm.com

■ Made
■ in
■ Germany



Made in Germany

Nabertherm with 500 employees worldwide have been developing and producing industrial furnaces for many different applications for 70 years. As a manufacturer, Nabertherm offers a very wide and deep range of furnaces. 150,000 satisfied customers in more than 100 countries offer proof of our commitment to excellent design, quality and cost efficiency. Short delivery times are ensured due to our complete inhouse production and our wide variety of standard furnaces.

Setting Standards in Quality and Reliability

Nabertherm does not only offer a wide range of standard furnaces. Professional engineering in combination with in house manufacturing provide for individual project planning and construction of tailor-made thermal process plants with material handling and charging systems. Complete thermal processes are realized by customized system solutions.

Innovative Nabertherm control technology provides for precise control as well as full documentation and remote monitoring of your processes. Our engineers apply state-of-the-art technology to improve the temperature uniformity, energy efficiency, reliability and durability of our systems with the goal of enhancing your competitive edge.

Global Sales and Service Network – Close to you

Nabertherm's strength is one of the biggest R&D departments in the furnace industry. In combination with central manufacturing in Germany and decentralized sales and service close to the customer we can provide for a competitive edge to live up to your needs. Long term sales partners in all important world markets ensure individual on-site customer service and consultation. There are certainly reference customers who are using similar furnaces or systems close to you.



Large Customer Test Center

What furnace is the right choice for this specific process? This question cannot always be answered easily. Therefore, we have set up our modern test center which is unique in respect to size and variety. A representative number of furnaces is available for tests for our customers.

Customer Service and Spare Parts

Our professional service engineers are available for you worldwide. Due to our complete inhouse production, we can despatch most spare parts from stock over night or produce with short delivery time.

Experience in Many Fields of Thermal Processing

In addition to furnaces for additive manufacturing, Nabertherm offers a wide range of standard furnaces and plants for many other thermal processing applications. The modular design of our products provides for customized solutions to you individual needs without expensive modifications.

Table of Contents

	Page
Additive Manufacturing	4
Which Furnace for Which Process?	8
Concepts for Drying, Debinding and Sintering of Parts with Binder Content	10
Safety Concepts for Processes which Generate a Combustible Atmosphere	12
 Retort Furnaces	
Hot-wall retort furnaces up to 1100 °C	14
Manual or semi-automatic tempering plants	18
Retort furnaces for catalytic debinding	19
Bottom loading retort furnaces up to 1100 °C	20
Pit-type retort furnaces up to 1100 °C	21
Cold-wall retort furnaces up to 2400 °C	22
Bottom loading retort furnace up to 2400 °C	27
Retort furnace cooling systems	29
 Chamber Furnaces with Brick Insulation or Fiber Insulation	
Chamber furnaces LH 15/.. - LH 216/..	30
Protective gas boxes and charging plates for models LH 15/.. - LH 216/..	32
Chamber furnaces with drawer bottom or as a bogie NW 150 - NW 1000	34
Protective gas boxes and protective gas hoods for chamber furnaces NW 150 - NW 1000	35
Chamber furnaces N 7/H - N 641/13	36
Protective gas boxes and charging plates for models N 7/H - N 641/13	37
Charging forks	39
Tool shop hardening systems MHS 31, MHS 41 and MHS 61	40
Protective gas hardening system SHS 41	41
 Forced Convection Furnaces	
Forced convection chamber furnaces NA 30/45 - N 500/85HA and protective gas boxes	42
Protective gas boxes for automotive (CQI-9) and aeronautic (AMS7NADCAP) norms	46
Sealed forced convection chamber furnaces NA-I and NA-SI	47
Forced convection pit-type furnaces SAL 30/45 - SAL 500/85 and protective gas boxes	48
Charging aid for models SAL 30/45 - SAL 500/85	49
Forced convection pit-type retort furnaces up to 850 °C	50
 Temperature Measurement in Gas Supply Systems	51
TUS Measuring Frame for Protective Gas Box	51
Gas Supply Systems	52
Vacuum Pump	53
Cooling Platforms and Charging Devices	54
Ashing Furnaces with Integrated Exhaust Gas Cleaning	56
High-Temperature Furnaces with MoSi₂ Heating Elements up to 1800 °C	57
Ovens, also with Safety Technology According to EN 1539	60
Chamber Ovens	62
Catalytic and Thermal Afterburning Systems, Exhaust Gas Washer	66
 Process control and documentation	
Temperature Uniformity and System Accuracy	68
AMS2750F, NADCAP, CQI-9	69
Nabertherm controller series 500	72
MyNabertherm app	74
Functions of the standard controllers	76
Process data storage and data input via PC	77
PLC controls	79
Process data storage	80
Nabertherm control center NCC	81



Additive Manufacturing



Retort furnace NR 150/11 for annealing of metal parts of 3D-printing



Oven TR 240 for drying of powders



Chamber oven KTR 2000 for curing after 3D-printing



Compact tube furnace for sintering or annealing under protective gases or in a vacuum after 3D-printing



HT 160/17 DB200 for debinding and sintering of ceramics after 3D-printing

Additive manufacturing allows for the direct conversion of design construction files into fully functional objects. With 3D-printing objects, from metals, plastics, ceramics, glass, sand or other materials are built-up in layers until they have reached their final shape.

Depending on the material, the layers are interconnected by means of a binder system or by laser technology.

Many methods of additive manufacturing require subsequent heat treatment of the manufactured components. The requirements for the furnaces for heat treatment depend on the component material, the working temperature, the atmosphere in the furnace and, of course, the additive production process.

Apart from the choice of the right model and process parameters the previous processes before the heat treatment also have an influence on the overall result. One important criteria for a good surface quality is that the components are cleaned properly before the heat treatment.

This is particularly important for the processes that are carried out under vacuum or in furnaces that have a high requirement for a low residual oxygen content. Minor leaks or contamination can lead to insufficient results. For this reason, regular cleaning and maintenance of the furnace is important.

In additive manufacturing, a distinction is made between printing with and without binder. Depending on the manufacturing process, different furnace types are used for the subsequent heat treatment.

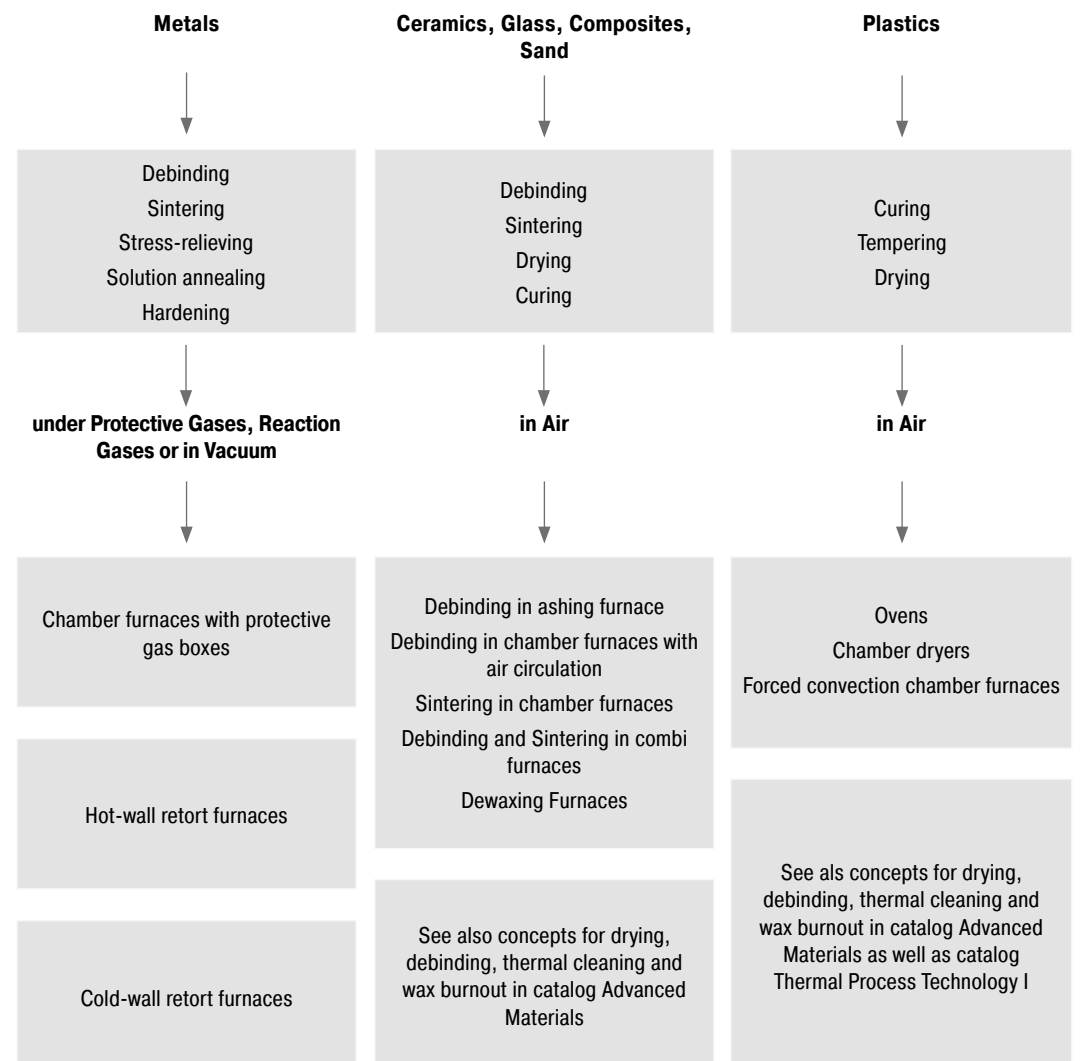

Binder-Free Systems

In binder-free additive manufacturing, in most cases, the components are produced with the powder-based laser melting process on a printing platform. In the meantime, other manufacturing processes have also become established on the market, which likewise require a corresponding heat treatment after the production process.

The tables below show typical materials and construction platform sizes of laser-based systems that are available on the market with suggestions with respect to furnace sizes, required temperature and atmosphere in the furnace.

Aluminum Components

Generally, aluminum is heat treated in air at temperatures between 150 °C and 450 °C.

Due to the very good temperature uniformity, forced convection chamber furnaces are suitable for processes such as tempering, aging, stress-relieving or preheating.



Printed aluminum part, heat treated in model N 250/85 HA (Manufacturer CETIM CERTEC on SUPCHAD platform)

Examples for max platform sizes	Forced convection chamber furnaces, see page 42 up to 450 °C ¹
210 x 210 mm	NA 30/45
280 x 280 mm	NA 60/45
360 x 360 mm	NA 120/45
480 x 480 mm	NA 250/45
600 x 600 mm	NA 500/45

¹Also available for 650 °C and 850 °C



Forced convection chamber furnace NA 250/45 for heat treatment in air

Stainless Steel and Titanium Components

In many cases, certain stainless steels and titanium are heat treated in a protective gas atmosphere at temperatures below 850 °C.

By using a protective gas box with the corresponding process gas supply, a standard furnace can be upgraded to a protective gas furnace. Depending on the type of process gas, the preflushing rate, the process flushing rate, and the condition of the box, it is possible to achieve residual oxygen concentrations of up to 100 ppm.

The forced convection chamber furnaces with protective gas boxes described below have a working temperature range between 150 °C and 850 °C. If the protective gas boxes are removed from the furnace, aluminum or steel components can also be heat treated in air.

Examples for platform sizes	Forced convection chamber furnaces, see page 42 up to 850 °C with protective gas box
100 x 100 mm	N 30/85 HA
200 x 200 mm	N 60/85 HA
280 x 280 mm	N 120/85 HA
400 x 400 mm	N 250/85 HA
550 x 550 mm	N 500/85 HA

The models listed in the table above are just a few examples.



Forced convection chamber furnace N 250/85 HA with protective gas box for heat treatment in a protective gas atmosphere



Hot-wall retort furnace NRA 150/09 for heat treatment in a protective gas atmosphere

With sensitive materials, such as titanium, the component may still oxidize due to the residual oxygen concentration in the protective gas box.

In these cases, hot-wall retort furnaces with a maximum temperature of 900 °C or 1100 °C are used. These gas tight retort furnaces are ideal for heat treatment processes that require a defined protective or reaction gas atmosphere. The compact models can also be designed for heat treatment under vacuum up to 600 °C. The risk of oxidation on the component is considerably reduced with these furnaces.

Examples for platform sizes	Hot-wall retort furnaces see page 14
200 x 200 mm	NR 20/11 and NR(A) 17/..
300 x 300 mm	NR 80/11 and NR(A) 50/..
300 x 500 mm	NR 80/11 and NR(A) 75/..
400 x 400 mm	NR 160/11 and NR(A) 150/..
400 x 800 mm	NR 160/11 and NR(A) 300/..



Titanium rods after heat treatment in NR 50/11 in argon atmosphere



Cold-wall retort furnace VHT 100/12-MO for processes in high vacuum

Cold-wall retort furnaces are used for processes in protective gas at temperatures above 1100 °C or under vacuum above 600 °C.

Examples for platform sizes	Cold-wall retort furnaces ¹ see page 22
100 x 100 mm	VHT 8/..
250 x 250 mm	VHT 40/..
350 x 350 mm	VHT 70/..
400 x 400 mm	VHT 100/..

¹Available with different heater materials and for different max. temperatures



Chamber furnace LH 60/12 with protective gas box for heat treatment in a protective gas atmosphere

Inconel or Cobalt-Chromium Components

Materials such as Inconel and cobalt-chromium are generally heat treated at temperatures from 850 °C up to between 1100 °C and 1150 °C. Various furnace families are used for these processes. In many cases, the chamber furnaces of the LH .. or NW .. series with protective gas boxes are sufficient to provide an outstanding price/performance ratio. Both furnace groups are suitable for temperatures between 800 °C and 1100 °C.

Examples for platform sizes	Chamber furnaces see page 30 and 34 up to 1100 °C with protective gas box
100 x 100 mm	LH 30/12
250 x 250 mm	LH 120/12
400 x 400 mm	LH 216/12
420 x 520 mm	NW 440
400 x 800 mm	NW 660

Systems with Binder

In 3D printing, organic binders, which evaporate during heat treatment, are used to build-up the part. The printed parts can be made of ceramic, metal, glass or sand. Depending on the evaporation volume, furnaces with graduated safety systems for debinding and sintering are used.

On pages 10 and 11 the different concepts are presented in a decision matrix and explained on the following pages.

Printing dimensions up to (w x d x h)	Debinding furnaces ¹ see catalog Advanced Materials	Sintering furnaces ² see catalog Advanced Materials
100 x 100 x 100 mm	L 9/11 BO	LHT 4/16
200 x 200 x 150 mm	L 9/11 BO	HT 40/16
300 x 400 x 150 mm	L 40/11 BO	HT 64/17

¹ Values for debinding like max. organic content, or evaporation rate have to be considered
² The furnaces are available with different max. furnace chamber temperatures



Muffle furnace L 40/11 BO with passive safety system and integrated post combustion for thermal debinding in air



High-temperature furnace HT 64/17 DB100 with passive safety system for debinding and sintering in air

Debinding and Sintering in Protective or Reaction Gas or under Vacuum

To protect metal components that were printed using a binder-based system against oxidation, two process steps, debinding and sintering, are carried out in an oxygen-free atmosphere.

Depending on the material and the binder system, debinding is carried out either in a non-flammable protective gas (IDB), under hydrogen (H₂), or catalytically in a mixture of nitric acid and nitrogen. Adapted safety systems are used to ensure the safety of these processes.

The table contains examples of furnaces which can be equipped with suitable safety technology. Hot-wall retort furnaces are used as debinding furnaces and cold-wall retort furnaces as sintering furnaces. Under certain circumstances, depending on the application, it is possible to use the same furnace for both processes.

Printing dimensions up to (w x d x h)	Hot-wall retort furnaces ¹ see page 14	Cold-wall retort furnaces ^{2, 3} see page 22
100 x 180 x 120 mm	NRA 17/..	VHT 8/..
180 x 320 x 170 mm	NRA 17/..	VHT 25/..
230 x 400 x 220 mm	NRA 50/..	VHT 40/..
300 x 450 x 300 mm	NRA 50/..	VHT 70/..
400 x 480 x 400 mm	NRA 150/..	VHT 100/..

¹ Safety systems see page 16 and 19, max. oven chamber temperatures see page 14
² Available with different heater materials and for different max. temperatures
³ With inner process chamber for the residual debinding



Retort furnace NRA 40/02 with cupboard for the acid pump

Which Furnace for Which Process?

The next two double pages give an overview of which furnaces can be used in additive manufacturing for which process. This double page describes furnaces which can be used for processes in which no combustible substances escape.

Atmosphere

Air

Maximum Temperature

300 °C

850 °C

1280 °C

650 °C

650 °C

Requirement Oxygen Content

21 %

21 %

21 %

1 %

0,10 %

Vacuum

-

-

-

-

-

Flammable Process Gas

-

-

-

-

-

Furnace Type

TR, page 60
KTR, page 62

NA, page 42
SAL, page 48

LH, page 30
NW, page 34
N, page 36
KTR, page 62

NA .. I, page 47

NA .. SI, page 47

Furnace Heating

Electric



Chamber oven KTR 2000 for curing after 3D-printing



Chamber furnace LH 60/12 with protective gas box for heat treatment in a protective gas atmosphere



Forced convection chamber furnace NA 250/45 for heat treatment in air

Process Gas			Vacuum	
1100 °C	1150 °C	2400 °C	≤ 600 °C	≥ 600 °C
0,01 %	0,00 %	0,00 %	0,00 %	0,00 %
-	-	≤ 10 ⁻⁵ mbar	≤ 10 ⁻⁵ mbar	≤ 10 ⁻⁵ mbar
-	x	x	x	x
With protective gas box LH, page 30 NW, page 34 N, page 36 NA*, page 42 SAL*, page 48	NR(A), page 14 SR(A), page 21 LBR(A), page 20	VHT, page 22 LBVHT, page 27	NR(A), page 14 SR(A), page 21 LBR(A), page 20	VHT, page 22 LBVHT, page 27

Electric



SAL 250/65



Cold-wall retort furnace VHT 100/12-MO for processes in high vacuum



Semi-automatic annealing plant with retort furnace NR 50/11 and water quenching bath on rails

*Tmax 850 °C

Concepts for Drying, Debinding and Sintering of Parts with Binder Content

Process	Drying Solvents			
Atmosphere	Air		Air	
Maximum Temperature for Debinding	300 °C	450 °C	450 °C	600 °C
Organic Quantity	Organic quantity low	Organic quantity low	Organic quantity low	Organic quantity medium
Requirement	Low requirement for temperature uniformity	Increased requirement for temperature uniformity	Increased requirement for temperature uniformity	Low requirement for temperature uniformity
Concept	LS	LS	DB10	BO
	Acc. to EN 1539 Type A. Monitored air exchange. Exhaust gas venting via nozzles in the on-site extraction system.	Acc. to EN 1539 Type A (NFPA 86 Class A). Monitored air exchange. Active venting of the exhaust gas via integrated exhaust gas fan.	Monitored air exchange. Active venting of the exhaust gas via integrated exhaust gas fan. Uncontrolled furnace underpressure.	Debinding process with control difficulties of heating ramp (exothermic reaction).
Furnace Type	KTR, page 62 TR .. LS, page 60		NA .. LS, page 42	L .. BO, page 56 HT .. DB, page 58
For Debinding			NA .. 45 DB10, page 42	
For Debinding and/or Sintering				
Post-Treatment of Exhaust Gases				Integrated thermal afterburning/catalytic afterburning

Furnace Heating: Electric (top bar), Gas (middle bar)

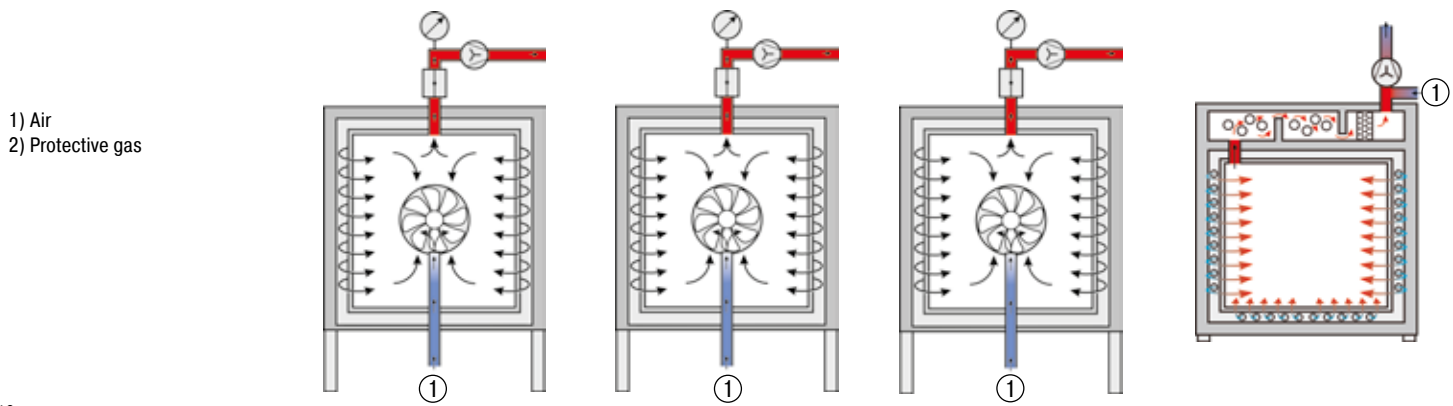

Debinding

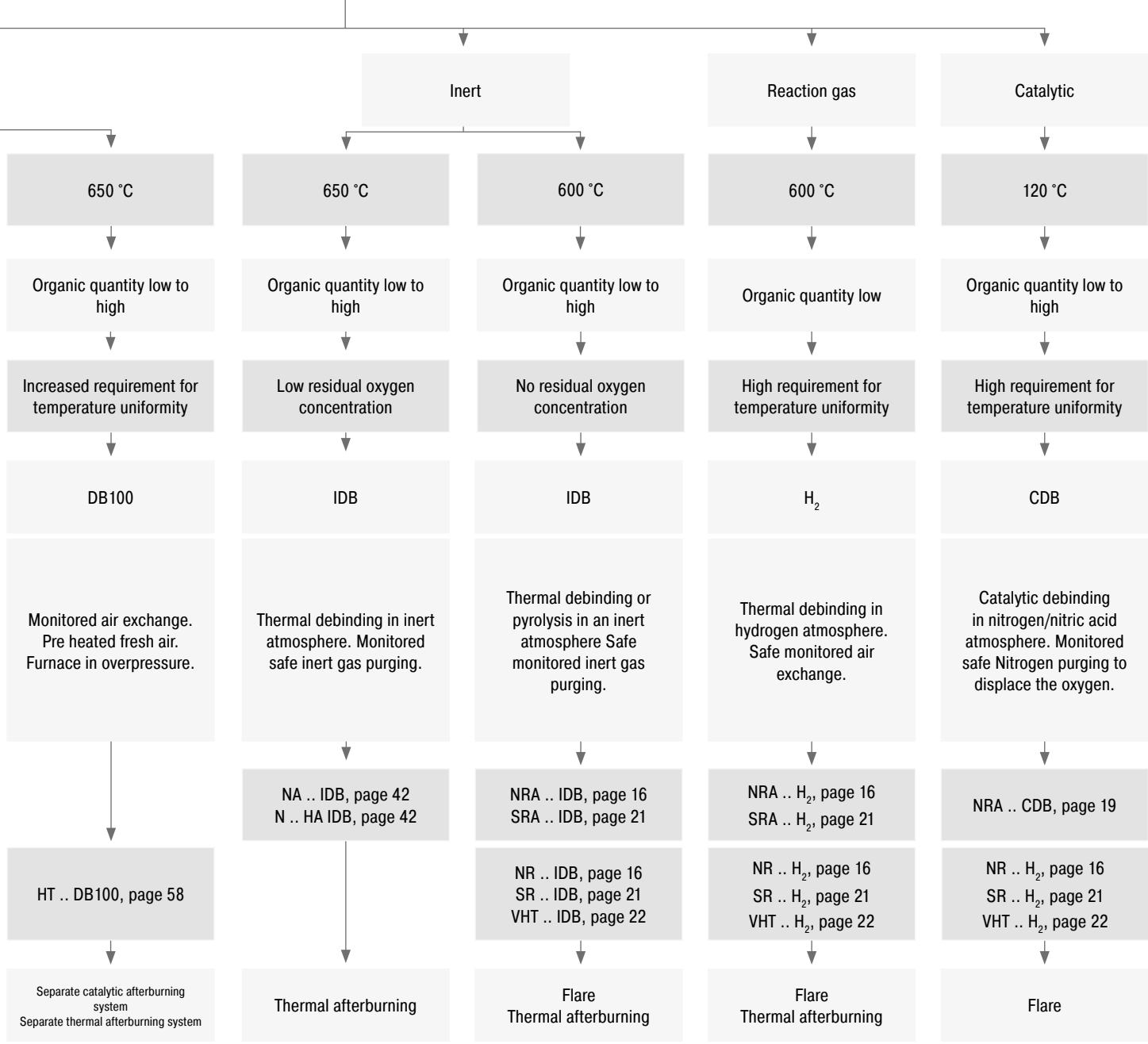

Electric

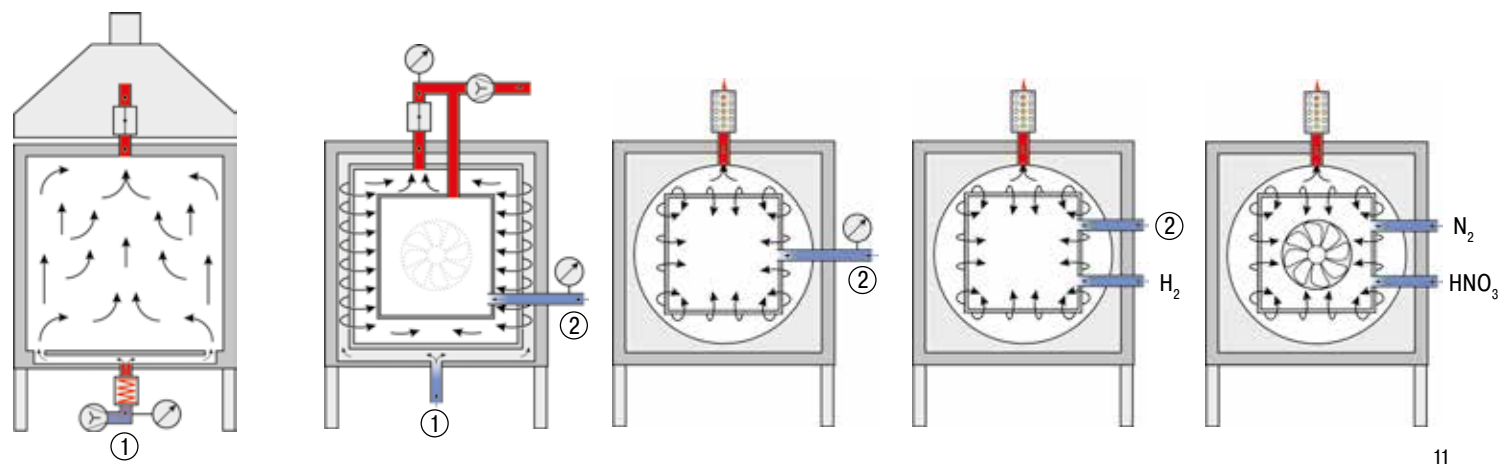

Safety Concepts for Processes which Generate a Combustible Atmosphere

During debinding e.g. from technical ceramics, hydrocarbons are released, which might generate an ignitable mixture depending on their concentration in the furnace chamber. Nabertherm offers tailor-made passive and active safety packages depending on the process and the amount of binder, which enable safe operation of the furnace.

I. Debinding in Air

Debinding in an Electrically Heated Furnace

For debinding in air with electric heating Nabertherm offers various debinding packages tailored to the individual process requirements. All debinding packages have professional integrated safety technology. Passive or active safety concepts are available, depending on the specific requirements. The passive safety concepts differ upon the requirements for the quantity of organic materials, process reliability, and temperature distribution.

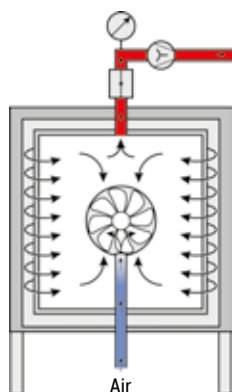

Passive Safety Concept

Nabertherm debinding furnaces are generally equipped with a passive safety concept to allow for a slow vaporization of flammable substances. The electrically heated furnaces work according to the dilution principle by introducing fresh air to reduce the degassing from the charge to a non-ignitable atmosphere in the furnace. The customer has to define the quantity of organic materials as well as the temperature curve, to make sure that the maximum permissible rate of vaporization is not exceeded. Thus, the customer is responsible for the function of the safety concept. The furnace DB safety package monitors all safety-relevant process parameters and initiates a respective emergency program in case of a malfunction. The passive safety concept has proven itself in practice based to its good price performance ratio. Depending on the process requirements, the following equipment packages are available.

DB10 Debinding Package for Air Circulation Furnaces (Convection Heating) up to 450 °C

The DB10 debinding package is the basic option for safe debinding in air circulation furnaces up to 450 °C. The furnace is equipped with an exhaust gas fan providing for a defined volume of air which is extracted from the furnace, thus allowing the volume of fresh air required for the debinding process to enter the furnace. The furnace is operated with negative pressure, which prevents an undefined emission of vaporization products.

Debinding Package for Laboratory Furnaces

The ashing furnaces have a passive safety system and integrated exhaust gas post combustion. An exhaust gas fan extracts flue gases from the furnace and simultaneously supplies fresh air to the furnace atmosphere with the result that sufficient oxygen is always available for the incineration process. The incoming air is guided behind the furnace heating and preheated to ensure good temperature uniformity. Exhaust gases are led from the furnace chamber to the integrated post combustion system, where they are postburned and catalytically cleaned. Directly after the incineration process (up to max. 600 °C) a subsequent process up to max. 1100 °C can take place.

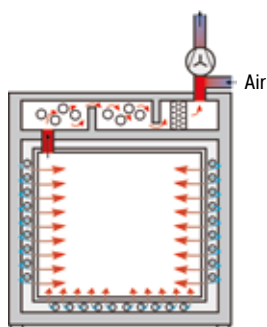

II. Safety Concept EN 1539 (NFPA 86) to Dry Liquid Solvents in Ovens

The safety technology of furnaces and dryers used for processes in which solvents or other flammable substances are released and vaporized relatively quickly is regulated throughout Europe in EN 1539 (or NFPA 86 in the USA)

Typical applications are drying of mold varnish, surface coatings, and impregnating resins. Users include the chemical industry as well as many other areas, such as the automotive, electric, plastic processing and metalworking industries.

The safety concept relates to preventing the formation of explosive mixtures through continuous air exchange in the entire vapor space.

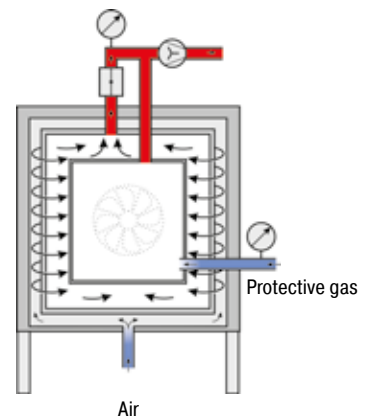

III. Debinding or Pyrolysis under Non-Flammable or Flammable Protective or Reaction Gases

IDB Safety Concept for Debinding in Protective Gas Boxes under Non-Flammable Protective Gases with Low Residual Oxygen

The IDB safety concept with an inert atmosphere in protective gas boxes is ideal for debinding processes under protective gas where a small amount of residual oxygen for the materials is permitted. The furnace technology in combination with a protective gas box made from heat-resistant stainless steel has a very good price performance ratio.

A monitored inert gas pre-flushing and conservation flushing during the process ensure that a residual oxygen concentration of 3 % is not exceeded in the protective gas box. The customer must check this limit value with regular measurements.

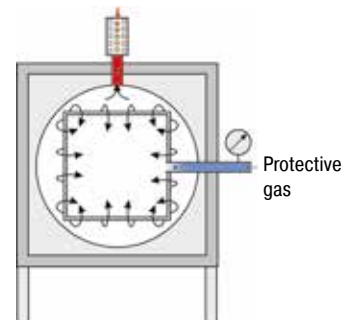

IDB Safety Concept in Retort Furnaces for Debinding under Non-Flammable Protective Gases or for Pyrolysis Processes

The retort furnaces in the NR(A) and SR(A) series are ideal for debinding under non-flammable protective gases or for pyrolysis processes. With the IDB option, the furnace chamber is flushed with protective gases. Exhaust gases are incinerated in an exhaust gas torch. The flushing and the torch function are monitored to ensure safe operation.

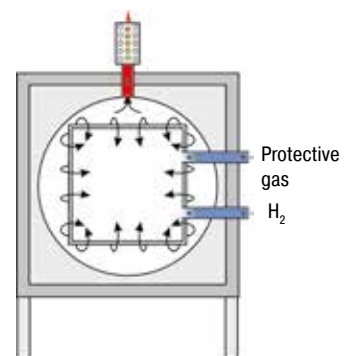

Safety Concept for Heat Treatment under Flammable Process Gases

If flammable process gases, such as hydrogen, are used, the retort furnace is also equipped and delivered with the required safety technology. Only components with the corresponding certification are used as safety-relevant sensors. The furnace is controlled by a failsafe PLC control system (S7300/safety control).

CDB Safety Package for Catalytic Debinding with Nitric Acid

The safety concept prevents explosive gas mixture forming when the furnace is operated with nitric acid. For this purpose, the gastight retort is automatically flushed with a controlled flow of nitrogen which displaces the atmospheric oxygen before nitric acid is introduced. During debinding, the monitored mixing ratio between the nitrogen and acid prevents an excess acid dosis and, or consequently, the formation of an explosive atmosphere.

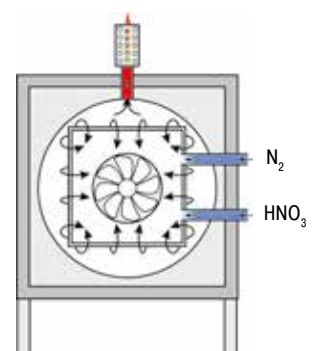

Hot-Wall Retort Furnaces up to 1100 °C

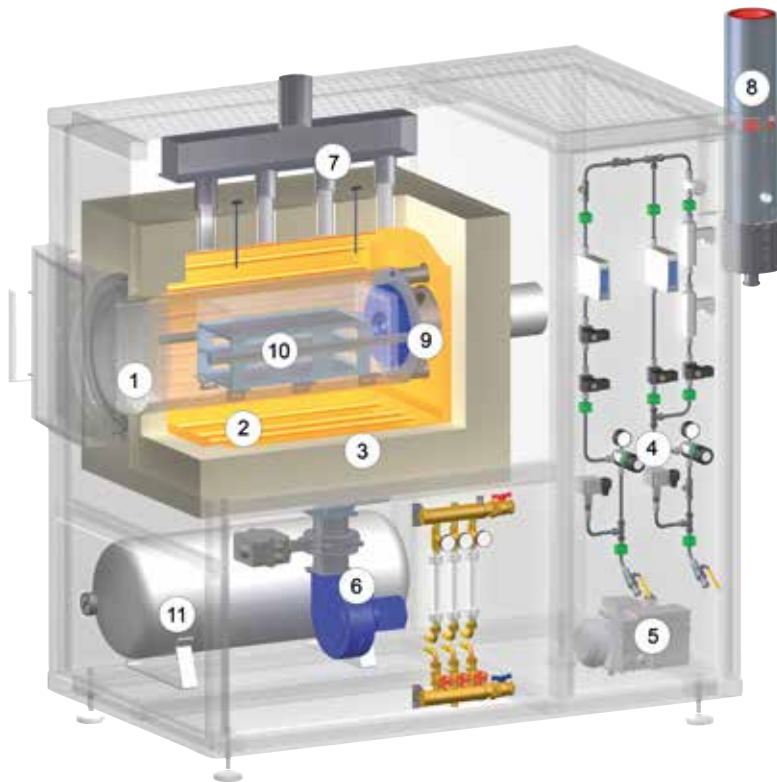

Schematic presentation of a hot-wall retort furnace with additional equipment

- 1 Retort
- 2 Heating
- 3 Insulation
- 4 Gas management system
- 5 Vacuum pump
- 6 Fan for indirect cooling
- 7 Outlet indirect cooling
- 8 Exhaust torch
- 9 Fan for gas circulation (NRA models)
- 10 Charging frame
- 11 Emergency flushing container

These gas tight retort furnaces are equipped with direct or indirect heating depending on temperature. They are perfectly suited for various heat treatment processes requiring a defined protective or a reaction gas atmosphere. These compact models can also be laid out for heat treatment under vacuum up to 600 °C. The furnace chamber consists of a gas tight retort with water cooling around the door to protect the special sealing. With the corresponding safety technology, retort furnaces are also suitable for applications under reaction gases, such as hydrogen or, in combination with the IDB package, for inert debinding or for pyrolysis processes.

Different model versions are available depending on the temperature range:



Inside heating in retort furnaces NRA ../06

Models NRA ../06 with Tmax 650 °C

- Heating elements located inside the retort
- Temperature uniformity up to +/- 5 °C inside the work space see page 68
- Retort made of 1.4571
- Gas circulation fan  in the back of the retort provides for optimal temperature uniformity
- Insulation made of mineral wool

Models NRA ../09 with Tmax 900 °C

Design like models NRA ../06 with following differences:

- Outside heating with heating elements around the retort
- Retort made of 1.4828
- Exclusive use of insulation materials without categorization according to EC Regulation No 1272/2008 (CLP). This explicitly means that alumino silicate wool, also known as "refractory ceramic fiber" (RCF), which is classified and possibly carcinogenic, is not used.

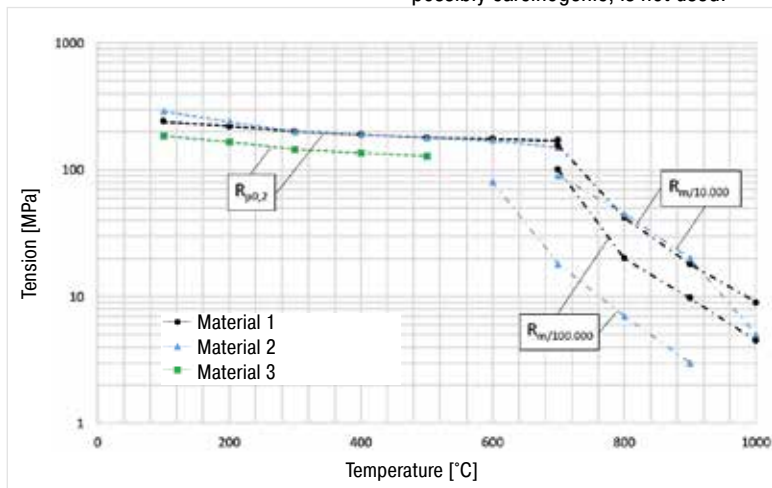

Short and long-term durability of retort materials

Models NR ../11 with Tmax 1100 °C

Design like models NRA ../09 with following differences:

- Retort made of 1.4841
- Without gas-circulation 



Retort furnace NRA 25/09

Retort furnace NRA 150/09 with controls H1700 and bayonet door lock

Basic version

- Compact housing with removable stainless steel sheets
- Controls and gas supply integrated in the furnace housing
- Welded charging supports in the retort resp. air-baffle box in the furnaces with atmosphere circulation
- Swivel door hinged on right side
- Open cooling water system
- Depending on furnace volume for 900 °C- and 1100 °C-models the control system is divided in one or more heating zones
- Furnace temperature control with measurement outside the retort
- Gas supply system for one non-flammable protective or reaction gas with flow meter and magnetic valve
- Port for vacuum pump for cold evacuation
- Operation under vacuum up to 600 °C with optional single-stage rotary vane pump
- Defined application within the constraints of the operating instructions
- NTLog Basic for Nabertherm controller: recording of process data with USB-flash drive
- Controls description see page 72



Charging of the retort furnace NRA 300/06 with a pallet truck

Additional equipment

- Upgrade for other non-flammable gases, H₂ version for flammable gases see page 16
- Automatic gas injection, including MFC flow controller for alternating volume flow, controlled with process control H3700, H1700
- Vacuum pump for evacuating of the retort up to 600 °C, attainable vacuum up to 10⁻⁵ mbar subject to selected pump and furnace type
- Indirect cooling see page 29
- Direct cooling see page 29
- Heat exchanger with closed-loop cooling water circuit for door cooling
- Measuring device for residual oxygen content
- Door heating
- Temperature control as charge control with temperature measurement inside and outside the retort
- Retort, made of 2.4633 for Tmax 1150 °C
- Process control and documentation via VCD software package or Nabertherm Control Center (NCC) for monitoring, documentation and control see page 72



Vacuum pump for cold evacuation of the retort

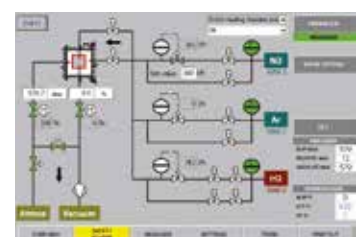

Process control H3700 for automatic version

Hot-Wall Retort Furnaces up to 1100 °C



Retort furnace NRA 400/03 IDB with thermal post combustion system

IDB Version for Debinding under Non-flammable Protective Gases or for Pyrolysis Processes

The retort furnaces of the NR and NRA product line are perfectly suited for debinding under non-flammable protective gases or for pyrolysis processes. The IDB version of the retort furnaces implements a safety concept by controlled inerting the furnace chamber with a protective gas. Exhaust gases are burned in a thermal post combustion. Both the purging and the torch function are monitored to ensure a safe operation.

- Process control under monitored overpressure
- Process control H1700 with PLC controls and graphic touch panel for data input
- Monitored gas pre-pressure of the process gas
- Bypass for safe flushing of furnace chamber with inert gas
- Thermal post combustion of exhaust gases



Retort furnace NRA 300/09 H₂ for heat treatment under hydrogen

H₂ Version for Operation with Flammable Process Gases

When a flammable process gas like hydrogen is used, the retort furnace is additionally equipped with the required safety technology. Only certified and industry proven safety sensors are used. The furnace is controlled by a fail-safe PLC control system (S7- 300F/safety controller).

- Supply of flammable process gas at controlled overpressure of 50 mbar relative
- Certified safety concept
- PLC controls with graphic touch panel H3700 for data input
- Redundant gas inlet valves for hydrogen
- Monitored pre-pressures of all process gases
- Bypass for safe flushing of furnace chamber with inert gas
- Torch for thermal post combustion of exhaust gases
- Emergency flood container for purging the furnace in case of failure

Model	Outer dimensions ¹ in mm			Work space dimensions in mm			Useful volume in l	Connected ¹ load in kW*
	W	D	H	w	d	h		
NR(A) 20/..	1100 ²	1600	1700	225	400	225	20	34
NR(A) 40/..	1200 ²	1600	1900	325	400	325	40	34
NR(A) 80/..	1200 ²	2000	1900	325	750	325	80	44
NR(A) 100/..	1400 ²	1800	2100	450	500	450	100	64
NR(A) 160/..	1400 ²	2100	2100	450	800	450	160	74
NR(A) 300/..	2200	3100	2600	590	900	590	300	157
NR(A) 400/..	2200	3400	2600	590	1200	590	400	187
NR(A) 500/..	2300 ³	3300	2700	720	1000	720	500	217
NR(A) 700/..	2300 ³	3500	2700	720	1350	720	700	287
NR(A) 1000/..	2300 ³	3600	2800	870	1350	870	1000	307

¹Outer dimensions and connected load of models NR .. /11

²Outer dimensions plus separate switchgear with gas supply package for flammable gases or PLC control

*Please see page 73 for more information about supply voltage

³Outer dimensions plus separate switchgear



Hot-wall retort furnace NRA 1700/06 with charging frame. For grey room/clean room installation for heat treatment of glass under protective gases.

With their high level of flexibility and innovation, Nabertherm offers the optimal solution for customer-specific applications.

Based on our standard models, we develop individual solutions also for integration in overriding process systems. The solutions shown on this page are just a few examples of what is feasible. From working under vacuum or protective gas via innovative control and automation technology for a wide selection of temperatures, sizes, lengths and other properties of retort furnaces – we will find the appropriate solution for a suitable process optimization.



Hot-wall retort furnace NRA 3300/06 with automatic door opening for the integration in a fully automatic quench & temper plant



Hot-wall retort furnaces NR 1000/11 in production

Manual or Semi-Automatic Tempering Plants for Hardening in Protective Gas with Subsequent Quenching outside the Furnace



Semi-automatic annealing plant with retort furnace NR 50/11 and water quenching bath on rails

Processes such as hardening of titanium or hardening/carburization, carburizing of steel, which require a controlled gas atmosphere with a subsequent quenching process, can be carried out with protective gas quenching and tempering plants. Such a system consists of a hot-wall retort furnace and an external quenching bath. Depending on the arrangement and design of the components, quenching delay times of up to 10 seconds can be achieved, so that the components are exposed to air for a short time only.

Chamber retort furnaces or pit-type retort furnaces can be offered for heavy components, where the batch is removed by crane after heat treatment and transferred to the quenching bath.

Depending on the requirements, the degree of automation can range from a purely manual version to a fully automated system with manipulator.

The quenching medium shall be selected taking into account the material to be treated and may be water, polymer, oil or a salt.

Additional equipment required for the process, such as cooling or heating or circulation of the medium, can be offered as well.

In a manual quenching and tempering plant, the process control is carried out by means of a Nabertherm controller. For more complex requirements, the controller is replaced by a PLC control. Process documentation in accordance with current standards such as the AMS2750F (NADCAP) is also possible.



NR 50/11 with charging rack for manual removal at high temperatures for quenching in an external bath

Retort Furnaces for Catalytic Debinding also as Combi Furnaces for Catalytic or Thermal Debinding

The retort furnaces NRA 40/02 CDB and NRA 150/02 CDB are specially developed for catalytic debinding of ceramics and metallic powder injection molded parts. They are equipped with a gastight retort with inside heating and gas circulation. During catalytic debinding, the polyacetal-containing (POM) binder chemically decomposes in the oven under nitric acid and is carried out of the oven by a nitrogen carrier gas and burned in an exhaust gas torch. Both retort furnaces have a comprehensive safety package to protect the operator and the surrounding.

Executed as combi furnace series CTDB these retort furnace can be used for either catalytic or thermal debinding incl. presintering if necessary and possible. The presintered parts can be easily transferred into the sintering furnace. The sintering furnace remains clean as no residual binder can exhaust anymore.

- Retort made of acid-resistant stainless steel 1.4571 with large swiveling door
 - Four-side heating inside the retort through chromium steel tube heating elements for good temperature uniformity
 - Horizontal gas circulation for uniform distribution of the process atmosphere
 - Acid pump and acid vessel (to be provided by the customer) accommodated in the furnace frame
 - Gas-fired exhaust gas torch with flame monitoring
-
- Extensive safety package with redundantly operating safety PLC for safe operation with nitric acid
 - Large, graphic process control H3700 for entering data and for process visualization
 - Emergency tank for flushing in case of a failure
 - Defined application within the constraints of the operating instructions

Version NRA .. CDB

- Tmax 200 °C
- Automatic gas supply system for nitrogen with mass flow controller
- Adjustable acid volume and correspondingly adjusted gas supply volumes

Version NRA .. CTDB

- Available for 600 °C and 900 °C with atmosphere circulation

Additional equipment

- Scale for the nitric acid vessel, connected to the PLC monitors the acid consumption and visualizes the fill level of the acid vessel (NRA 150/02 CDB)
- Lift truck for easy loading of the furnace
- Cupboard for acid pump
- Process control and documentation via Nabertherm Control Center (NCC) for monitoring, documentation and control see page 72



Retort furnace NRA 40/02 with cupboard for the acid pump



Acid pump for nitric acid



Retort with internal heating

Model	Tmax °C	Inner dimensions in mm			Volume in l	Outer dimensions ³ in mm			Heating power in kW ²	Electrical connection*	Weight in kg	Acidic quantity (HNO ₃)	Nitrogen (N ₂)
		w	d	h		W	D	H					
NRA 40/02 CDB	200	300	450	300	40	1400	1600	2400	2	3-phase ¹	800	max. 70 ml/h	1000 l/h
NRA 150/02 CDB	200	450	700	450	150	1650	1960	2850	20	3-phase ¹	1650	max. 180 ml/h	max. 4000 l/h

¹Heating only between two phases

²Depending on furnace design connected load might be higher

³External dimensions vary when furnace is equipped with additional equipment. Dimensions on request.

*Please see page 73 for more information about supply voltage

Bottom Loading Retort Furnaces up to 1100 °C



Bottom loading retort furnace
LBR 300/11 H₂ with safety technology for
operation with Hydrogen as process gas



Gas management system at
bottom loading retort furnace
LBR 300/11 H₂

The bottom loading retort furnaces of the LBR series are suitable for production processes that are carried out in protective/reaction gas atmosphere. With regard to the basic performance data, these models are constructed like the SR models. Their size and design with electro-hydraulically driven lifting bottom make it easier to load heavy duties. The retort furnaces are available in different sizes and designs.



Basic version (all models)

- Tmax 650 °C, 900 °C or 1100 °C
- Frame-mounted housing with stainless steel sheets
- Charging from the front
- Electro-hydraulically driven furnace bottom
- Gas supply system for a non-flammable protective gas or reaction gas with flow meter and solenoid valve
- Temperature control designed as furnace chamber control, see control alternative page 71
- Connection possibility for an optional vacuum pump (cold evacuation or operation up to 600 °C under vacuum)
- Defined application within the constraints of the operating instructions
- NTLog Basic for Nabertherm controllers: recording of process data with USB flash drive

Additional equipment, H₂ version and IDB version see models NR and NRA

Pit-Type Retort Furnaces up to 1100 °C

The retort furnaces SR and SRA (with gas circulation) are designed for operation under non-flammable or flammable protective or reaction gases. The hot-wall retort furnaces are loaded from above by crane or other lifting equipment provided by the customer. In this way, even large charge weights can be loaded into the furnace chamber.

Depending on the temperature range in which the furnace be used, the following models are available:

Models SRA ../06 with Tmax 650 °C

- Heating inside the retort
- Gas-circulation  with powerful fan in the furnace lid
- Temperature uniformity up to +/- 5 °C inside the work space see page 68
- Single-zone control
- Retort made of 1.4571
- Insulation made of high-grade mineral wool

Models SRA ../09 with Tmax 900 °C

Design like models SR../06 with following differences:

- All-around heating from outside of the retort
- Exclusive use of insulation materials without categorization according to EC Regulation No 1272/2008 (CLP). This explicitly means that alumino silicate wool, also known as "refractory ceramic fiber" (RCF), which is classified and possibly carcinogenic, is not used.
- Retort made of 1.4828

Models SR ../11 with Tmax 1100 °C

Design like models SR../09 with following differences:

- Without gas-circulation 
- Top down multi-zone control of the furnace heating
- Retort made of 1.4841

Standard Equipment (all models)

Design like standard equipment of models NR and NRA with following differences:

- Compact housing in frame construction with inserted stainless steel sheets
- Charging from above with crane or other lifting equipment from customer
- Hinged lid with opening to the side
- Welded charging frame resp. gas-guiding box for furnaces with circulation
- Gas-supply system for one non-flammable protective or reactive gas with flowmeter and magnetic valve
- Furnace temperature control see control alternative page 71
- Possible connection of an optional vacuum pump (for cold evacuation or for processes up to 600 °C under vacuum)
- Defined application within the constraints of the operating instructions
- NTLog Basic for Nabertherm controller: recording of process data with USB-flash drive

Additional equipment, H₂ version or IDB version see models NR and NRA

Model	Tmax °C	Inner dimensions of alloy retort		Volume in l	Outer dimensions ¹ in mm			Electrical connection*	Weight in kg
		ø in mm	h in mm		W	D	H		
SR(A) 17/..	650, 900 or 1100	250	350	17	1300	1700	1800	3-phase	600
SR(A) 25/..		250	500	25	1300	1900	1800	3-phase	800
SR(A) 50/..		400	450	50	1400	2000	1800	3-phase	1300
SR(A) 100/..		400	800	100	1400	2000	2100	3-phase	1500
SR(A) 200/..		600	700	200	1600	2200	2200	3-phase	2100
SR(A) 300/..		600	1000	300	1600	2200	2500	3-phase	2400
SR(A) 500/..		800	1000	500	1800	2400	2700	3-phase	2800
SR(A) 600/..		800	1200	600	1800	2400	2900	3-phase	3000
SR(A) 800/..		1000	1000	800	2000	2600	2800	3-phase	3100
SR(A) 1000/..		1000	1300	1000	2000	2600	3100	3-phase	3300
SR(A) 1500/..		1200	1300	1500	2200	2800	3300	3-phase	3500

*Please see page 73 for more information about supply voltage

¹External dimensions vary when furnace is equipped with additional equipment. Dimensions on request.



Retort furnace SRA 300/06 with charging basket



Front made of textured stainless steel



Retort furnace SRA 200/09

Cold-Wall Retort Furnaces up to 2400 °C



Retort furnace VHT 500/22-GR H₂ with CFC-process box and extension package for operation under hydrogen

The compact retort furnaces of the VHT product line are available as electrically heated chamber furnaces with graphite, molybdenum, tungsten or MoSi₂ heating. A wide variety of heating designs as well as a complete range of accessories provide for optimal retort furnace configurations even for sophisticated applications.

The vacuum-tight retort allows heat treatment processes either in protective and reaction gas atmospheres or in a vacuum, subject to the individual furnace specs to 10⁻⁵ mbar. The basic furnace is suited for operation with non-flammable protective or reactive gases or under vacuum. The H₂ version provides for operation under hydrogen or other flammable gases. Key of the specification up is a certified safety package providing for a safe operation at all times and triggers an appropriate emergency program in case of failure.

Alternative Heating Specifications

In general the following variants are available with respect to the process requirements:



Graphite heating chamber

VHT ...-GR with Graphite Insulation and Heating

- Suitable for processes under protective and reaction gases or under vacuum
- Tmax 1800 °C, 2200 °C or 2400 °C (VHT 40/.. - VHT 100/..)
- Max. vacuum up to 10⁻⁴ mbar depending on pump type used
- Graphite felt insulation



Molybdenum or tungsten heating chamber

VHT ...-MO or VHT ...-W with Molybdenum or Tungsten Heating

- Suitable for high-purity processes under protective and reaction gases or under high vacuum
- Tmax 1200 °C, 1600 °C or 1800 °C (see table)
- Max. vacuum up to 10⁻⁵ mbar depending on pump type used
- Insulation made of molybdenum resp. tungsten radiation sheets



Molybdenumdisilicide heater and fiber insulation

VHT ...-KE with Fiber Insulation and Heating through Molybdenum Disilicide Heating Elements

- Suitable for processes under protective and reaction gases, in air or under vacuum
- Tmax 1800 °C
- Max. vacuum up to 10⁻² mbar (up to 1300 °C) depending on pump type
- Insulation made of high purity aluminum oxide fiber
- Exclusive use of insulation materials without categorization according to EC Regulation No 1272/2008 (CLP). This explicitly means that alumino silicate wool, also known as "refractory ceramic fiber" (RCF), which is classified and possibly carcinogenic, is not used.

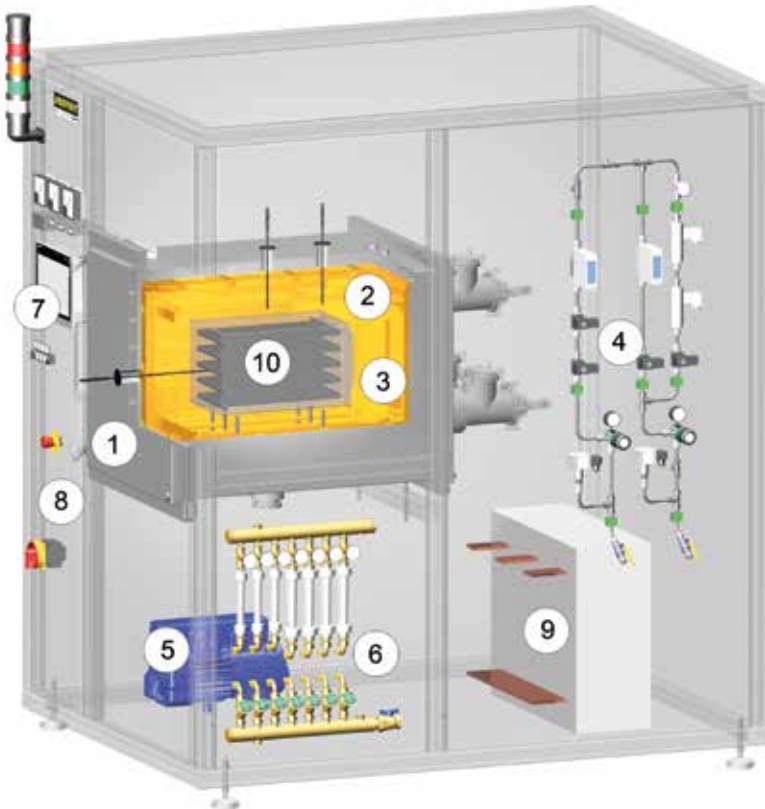

Schematic presentation of a cold-wall retort furnace with additional equipment

- 1 Retort
- 2 Heating
- 3 Insulation
- 4 Gas management system
- 5 Vacuum pump
- 6 Cooling water distribution
- 7 Controls
- 8 Integrated switchgear
- 9 Heating transformer
- 10 Charging frame inside the inner process chamber

Basic version

- Standard furnace sizes 8 - 500 liters
- Water-cooled retort made of stainless steel
- Frame made of stable steel profiles, easy to service due to easily removable stainless steel panels
- Housing of the VHT 8 model on castors for easy repositioning of furnace
- Cooling water manifold with manual tap, automatic flow monitoring, open-loop cooling water system
- Adjustable cooling water circuits with flowmeter and temperature indicator and overtemperature protection
- Switchgear and controller integrated in furnace housing
- Process control with controller P570
- Over-temperature limiter with adjustable cutout temperature as temperature limiter to protect the oven and load
- Manual operation of the process gas and vacuum functions
- Manual gas supply for one process gas (N₂, Ar or non-flammable forming gas) with adjustable flow
- Bypass with manual valve for rapid filling or flooding of furnace chamber
- Manual gas outlet with overflow valve (20 mbar relative) for over-pressure operation
- Single-stage rotary vane pump with ball valve for pre-evacuating and heat treatment in a rough vacuum to 5 mbar
- Pressure gauge for visual pressure monitoring
- Defined application within the constraints of the operating instructions



Retort furnace VHT 8/16-MO with automation package



Retort furnace VHT 100/16-MO with automation package



Additional equipment housing/heater

- Housing, optionally divisible, for passing through narrow door frames (VHT 8)
- Lift door
- Individual heating concepts

Additional equipment gas management system

- Manual gas supply for second process gas (N_2 , Ar or non-flammable forming gas) with adjustable flow and bypass
- Mass flow controller for alternating volume flow and generation of gas mixtures with second process gas (only with automation package)
- Inner process box made of molybdenum, tungsten, graphite or CFC, especially recommended for debinding processes. The box is installed in the furnace with direct gas inlet and outlet and provides for better temperature uniformity. Generated exhaust gases will be directly lead out the inner process chamber during debinding. The change of gas inlet pathes after debinding results in a clean process gas atmosphere during sintering.

Retort furnace VHT 40/22-GR with motorized lift door and front frame for connection to a glovebox



Heat treatment of copper bars under hydrogen in retort furnace VHT 8/16-MO

Additional equipment vacuum

- Two-stage rotary vane pump with ball valve for pre-evacuating and heat-treating in a fine vacuum (up to 10^{-2} mbar) incl. electronic pressure sensor
- Turbo molecular pump with slide valve for pre-evacuation and for heat treatment in a high vacuum (up to 10^{-5} mbar) including electronic pressure sensor and booster pump
- Other vacuum pumps on request
- Partial pressure operation: protective gas flushing at controlled underpressure (only with automation package)

Additional equipment cooling

- Heat exchanger with closed-loop cooling water circuit
- Direct cooling see page 29



Thermocouple, type S with automatic pull-out device for precise control results in the low temperature range

Additional equipment for controls and documentation

- Charge thermocouple with display
- Temperature measurement at 2200 °C models with pyrometer in the upper temperature range and thermocouple, type C with automatic pull-out device for precise control results in the low temperature range (VHT 40/..-GR and larger)
- Automation package with process control H3700
 - 12" graphic touch panel
 - Input of all process data like temperatures, heating rates, gas injection, vacuum at the touch panel
 - Display of all process-relevant data on a process control diagram
 - Automatic gas supply for one process gas (N_2 , argon or non-flammable forming gas) with adjustable flow
 - Bypass for flooding and filling the chamber with process gas controlled by the program
 - Automatic pre- and post programs, including leak test for safe furnace operation
 - Automatic gas outlet with bellows valve and overflow valve (20 mbar relative) for over-pressure operation
 - Transducer for absolute and relative pressure
- Process control and documentation via VCD software package or Nabertherm Control Center (NCC) for monitoring, documentation and control see page 72



Turbo-molecular pump



Single-stage rotary vane pump for heat treatment in a rough vacuum to 5 mbar



Two-stage rotary vane pump for heat treatment in a vacuum to 10⁻² mbar



Turbo-molecular pump with booster pump for heat treatment in a vacuum to 10⁻⁵ mbar

Process Box for Debinding in Inert Gas

Certain processes require charges to be debinded in non-flammable protective or reactive gases. For these processes we fundamentally recommend a hot-wall retort furnace (see models NR .. or SR ..). These retort furnaces can ensure that the formation of condensation will be avoided as thoroughly as possible.

If there is no way to avoid the escape of small amounts of residual binder during the process, even in the VHT furnace, the retort furnace should be designed to meet this contingency.

The furnace chamber is equipped with an additional process box that has a direct outlet to the exhaust gas torch through which the exhaust gas can be directly vented. This system enables a substantial reduction in the amount of furnace chamber contamination caused by the exhaust gases generated during debinding.

Depending on the exhaust gas composition the exhaust gas line can be designed to include various options.

- Exhaust gas torch for burning off the exhaust gas
- Condensation trap for separating out binding agents
- Exhaust gas post-treatment, depending on the process, via exhaust gas washers
- Heated exhaust gas outlet to avoid condensation deposits in the exhaust gas line



Graphite inner process chamber incl. charge holder

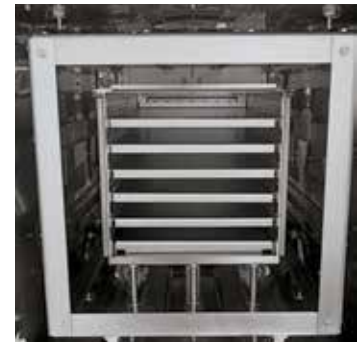

Molybdenum inner process chamber incl. six charge supports



Front made of textured stainless steel

	VHT ../.-GR	VHT ../.-MO	VHT ../18-W	VHT ../18-KE
Tmax	1800 °C, 2200 °C or 2400 °C	1200 °C or 1600 °C	1800 °C	1800 °C
Inert gas	✓	✓	✓	✓
Air/Oxygen	-	-	-	✓
Hydrogen	✓ ^{3,4}	✓ ³	✓ ³	✓ ^{1,3}
Rough vacuum and fine vacuum (>10 ⁻³ mbar)	✓	✓	✓	✓ ²
High vacuum (<10 ⁻³ mbar)	✓ ⁴	✓	✓	✓ ²
Material of heater	Graphite	Molybdenum	Tungsten	MoSi ₂
Material of insulation	Graphite felt	Molybdenum	Tungsten/Molybdenum	Ceramic fiber

¹Tmax reduces to 1400 °C

²Depending on the temperature

³Only with safety package for flammable gases

⁴Up to 1800 °C

Model	Inner dimensions of process box in mm			Volume in l
	w	d	h	
VHT 2/..	80	125	150	1.5
VHT 8/..	120	210	150	3.5
VHT 25/..	200	350	200	14.0
VHT 40/..	250	430	250	25.0
VHT 70/..	325	475	325	50.0
VHT 100/..	425	500	425	90.0
VHT 250/..	575	700	575	230.0
VHT 500/..	725	850	725	445.0

Model	Inner dimensions in mm			Volume in l	Max. charge weight/kg	Outer dimensions ⁶ in mm			Heating power in kW ⁴			
	w	d	h			W	D	H	Graphite	Molybdenum	Tungsten	Ceramic fiber
VHT 2/..	110	125	150	2	2	1250 (800) ¹	1000	2000	15/15 ⁻²	-	-	-
VHT 8/..	170	240	200	8	5	1250 (800) ¹	1100	2700 ⁵	27/27 ⁻²	19/34 ³	50	12
VHT 25/..	250	400	250	25	20	1500	2500	2200	70/90 ⁻²	45/65 ³	85	25
VHT 40/..	300	450	300	40	30	1600	2600 ⁵	2300	83/103/125 ²	54/90 ³	110	30
VHT 70/..	375	500	375	70	50	1800 ⁵	3300 ⁵	2400	105/125/150 ²	70/110 ³	130	55
VHT 100/..	450	550	450	100	75	1900	3500 ⁵	2500	131/155/175 ²	90/140 ³	on request	85
VHT 250/..	600	750	600	250	175	3000 ¹	4300	3100	180/210 ⁻²	on request	on request	on request
VHT 500/..	750	900	750	500	350	3200 ¹	4500	3300	220/260 ⁻²	on request	on request	on request

¹With separated switching system unit

²1800 °C/2200 °C

³1200 °C/1600 °C

⁴Depending on furnace design connected load might be higher

⁵Dimensions may be smaller depending on the heater type

⁶External dimensions vary when furnace is equipped with additional equipment. Dimensions on request.



Retort furnace VHT 100/15-KE H₂ with fiber insulation and extension package for operation under hydrogen, 1400 °C



Retort furnace VHT 40/16-MO H₂ with hydrogen extension package and process box

H₂ Version for Operation with Hydrogen or other Reaction Gases

In the H₂ version the retort furnaces can be operated under hydrogen or other reaction gases. For these applications, the systems are additionally equipped with the required safety technology. Only certified and industry proven safety sensors are used. The retort furnaces are controlled by a fail-safe PLC control system (S7-300F/safety controller).

- Certified safety concept
- Automation package (additional equipment see page 24)
- Redundant gas inlet valves for hydrogen
- Monitored pre-pressures of all process gases
- Bypass for safe purging of furnace chamber with inert gas
- Pressure-monitored emergency flooding with automated solenoid valve opening
- Electric or gas-heated exhaust gas torch for H₂ post-combustion
- Atmospheric operation: H₂-purging of retort starting from room temperature at controlled over pressure (50 mbar relative)

Additional equipment

- Partial pressure operation: H₂ flushing at underpressure in the retort starting from 750 °C furnace chamber temperature
- Inner process hood in the retort for debinding under hydrogen
- Process control and documentation via Nabertherm Control Center (NCC) for monitoring, documentation and control see page 72



Gas management system

Bottom Loading Retort Furnace up to 2400 °C



Retort furnace LBVHT 250/20-W with tungsten heating chamber

The LBVHT model series with bottom loading specification are especially suitable for production processes which require either protective or reaction gas atmosphere or a vacuum. The basic performance specifications of these models are similar to the VHT models. Their size and design with electro-hydraulically driven table facilitate charging during production. The retort furnaces are available in various sizes and designs. Similar like the VHT models, these furnaces can be equipped with different heating concepts.

- Standard furnace sizes between 100 and 600 liters
- Designed as bottom loading retort furnace with electro-hydraulically driven table for easy and well-arranged charging
- Prepared to carry heavy charge weights
- Different heating concepts using
 - Graphite heating chamber up to Tmax 2400 °C
 - Molybdenum heating chamber up to Tmax 1600 °C
 - Tungsten heating chamber up to Tmax 2000 °C
- Frame structure filled with textured stainless steel sheets
- Standard design with gassing system for non-flammable protective or reaction gases
- Automatic gas supply system which also allows for operation with several process gases as additional equipment
- Gas supply systems for operating with hydrogen or other combustible reaction gases incl. safety package as additional equipment
- Switchgear and control box as well as gassing system integrated into the furnace housing
- Further product characteristics of the standard furnace as well as possible additional equipment can be found in the description of the VHT furnaces from Page 22



Retort furnace LBVHT 600/24-GR



Retort furnace LBVHT with graphite heating chamber

Model	Tmax °C	Model	Tmax °C	Model	Tmax °C	Inner dimensions in mm		Volume in l	Electrical connection*
						Ø	h		
LBVHT 100/16-MO	1600	LBVHT 100/20-W	2000	LBVHT 100/24-GR	2400	450	700	100	3-phase
LBVHT 250/16-MO	1600	LBVHT 250/20-W	2000	LBVHT 250/24-GR	2400	600	900	250	3-phase
LBVHT 600/16-MO	1600	LBVHT 600/20-W	2000	LBVHT 600/24-GR	2400	800	1200	600	3-phase

*Please see page 73 for more information about supply voltage



Retort Furnace Cooling Systems

Indirect cooling (hot-wall retort furnaces)

- Ambient air is blown onto the outer retorte surface to cool it down. The waste heat is removed via the exhaust air outlet of the furnace.
- The charge is cooled indirectly, which means that the atmosphere in the retort is not affected by the cooling
- The charge cannot be quenched with the cooling system

Direct cooling (cold-wall and hot-wall retort furnaces)

- Rapid gas cooling in the retort. For this purpose, the furnace atmosphere is circulated through a heat exchanger.
- The system pressure is not increased by the cooling; there is no gas quenching at high pressure
- Not available for processes with flammable furnace atmospheres

Cooling Behavior of Hot-Wall Retort Furnace with Charge

(Example: NRA 50/09 with charge of 40 kg)

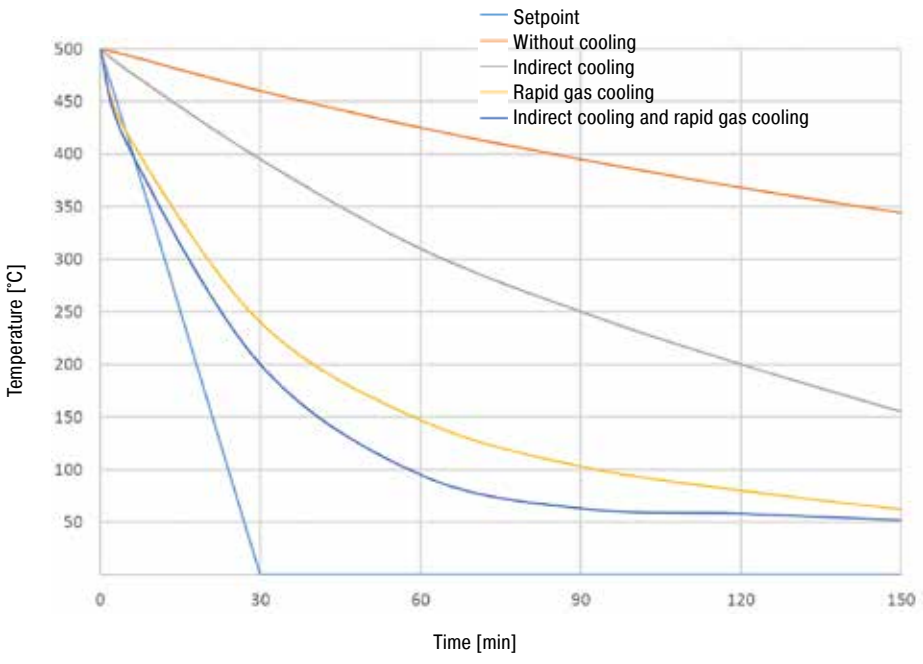

Cooling Behavior of Cold-Wall Retort Furnace with Charge

(Example: VHT 8/06-MO with charge of 10 kg)

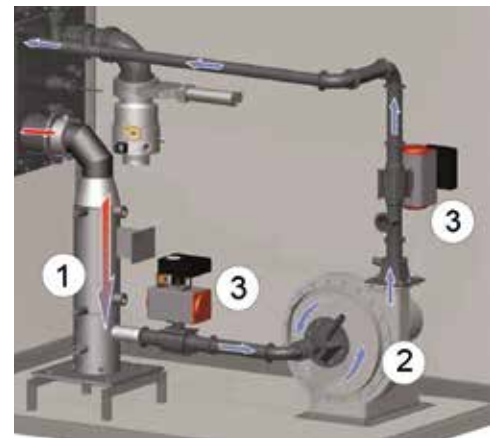
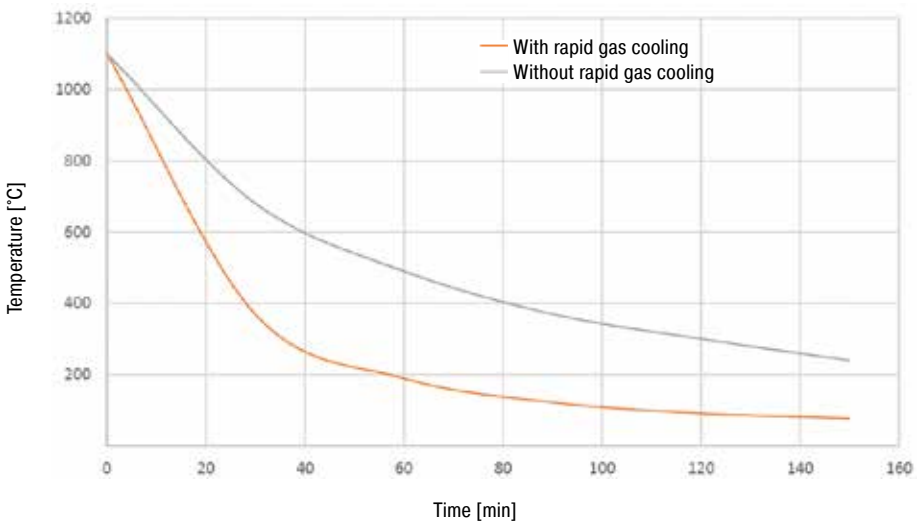

Schematic presentation of rapid gas cooling

- 1 Gas heat exchanger
- 2 Radial fan
- 3 Shut-off valves



Fan cooling, hot-wall retort furnace NRA 400/03



Rapid gas cooling, cold-wall retort furnace VHT 8/16-MO

Chamber Furnaces with Brick Insulation or Fiber Insulation



Chamber furnace LH 30/14



LH 60/12 with manual lift door and protective gas box for non-flammable protective or reactive gases



LF furnace design provides for shorter heating and cooling times

The chamber furnaces LH 15/12 - LF 120/14 have been trusted for many years as professional chamber furnaces for the laboratory. These furnaces are available with either a robust insulation of light refractory bricks (LH models) or with a combination insulation of refractory bricks in the corners and low heat storage, quickly cooling fiber material (LF models). With a wide variety of optional equipment, these chamber furnaces can be optimally adapted to your processes.

- Tmax 1200 °C, 1300 °C, or 1400 °C
- Dual shell housing with rear ventilation, provides for low shell temperatures
- High furnace chamber with five-sided heating for very good temperature uniformity
- Heating elements on support tubes ensure free heat radiation and a long service life
- Controller mounted on furnace door and removable for comfortable operation
- Protection of bottom heating and flat stacking surface provided by embedded SiC plate in the floor
- LH models: multi-layered insulation of light refractory bricks and special backup insulation
- LF models: high-quality fiber insulation with corner bricks for shorter heating and cooling times. Exclusive use of insulation materials without categorization according to EC Regulation No 1272/2008 (CLP). This explicitly means that aluminosilicate wool, also known as "refractory ceramic fiber" (RCF), which is classified and possibly carcinogenic, is not used.
- Door with brick-on-brick seal, hand fitted
- Short heating times due to high installed power
- Self-supporting arch for high stability and greatest possible protection against dust
- Quick lock on door
- Motorized exhaust air flap
- Freely adjustable air inlet integrated in furnace floor
- Base included
- Defined application within the constraints of the operating instructions
- NTLog Basic for Nabertherm controller: recording of process data with USB-flash drive
- Controls description see page 72



Gas supply system for non-flammable protective or reactive gas with shutoff valve and flow meter with regulator valve, optionally with magnetic valve



Chamber furnace LF 60/14 with fresh air fan to accelerate the cooling times

Additional equipment

- Parallel swinging door, pivots away from operator, for opening when hot
- Lift door with electro-mechanic linear drive
- Separate wall-mounting or floor standing cabinet for switchgear
- Cooling fan for shorter cycle times
- Protective gas connection to purge with non-flammable protective or reaction gases
- Manual or automatic gas supply system
- Scale to measure weight reduction during annealing
- Process control and documentation via VCD software package or Nabertherm Control Center (NCC) for monitoring, documentation and control see page 72



Chamber furnace LH 30/12 with manual lift door

Model	Tmax °C	Inner dimensions in mm			Volume in l	Outer dimensions ² in mm			Connected load kW	Electrical connection*	Weight in kg
		w	d	h		W	D	H			
LH 15/12	1200	250	250	250	15	680	860	1230	5.0	3-phase ¹	170
LH 30/12	1200	320	320	320	30	710	930	1290	7.0	3-phase ¹	200
LH 60/12	1200	400	400	400	60	790	1080	1370	8.0	3-phase	300
LH 120/12	1200	500	500	500	120	890	1180	1470	12.0	3-phase	410
LH 216/12	1200	600	600	600	216	990	1280	1590	20.0	3-phase	450
LH 15/13	1300	250	250	250	15	680	860	1230	7.0	3-phase ¹	170
LH 30/13	1300	320	320	320	30	710	930	1290	8.0	3-phase ¹	200
LH 60/13	1300	400	400	400	60	790	1080	1370	11.0	3-phase	300
LH 120/13	1300	500	500	500	120	890	1180	1470	15.0	3-phase	410
LH 216/13	1300	600	600	600	216	990	1280	1590	22.0	3-phase	460
LH 15/14	1400	250	250	250	15	680	860	1230	8.0	3-phase ¹	170
LH 30/14	1400	320	320	320	30	710	930	1290	10.0	3-phase ¹	200
LH 60/14	1400	400	400	400	60	790	1080	1370	12.0	3-phase	300
LH 120/14	1400	500	500	500	120	890	1180	1470	18.0	3-phase	410
LH 216/14	1400	600	600	600	216	990	1280	1590	26.0	3-phase	470
LF 15/13	1300	250	250	250	15	680	860	1230	7.0	3-phase ¹	150
LF 30/13	1300	320	320	320	30	710	930	1290	8.0	3-phase ¹	180
LF 60/13	1300	400	400	400	60	790	1080	1370	11.0	3-phase	270
LF 120/13	1300	500	500	500	120	890	1180	1470	15.0	3-phase	370
LF 15/14	1400	250	250	250	15	680	860	1230	8.0	3-phase ¹	150
LF 30/14	1400	320	320	320	30	710	930	1290	10.0	3-phase ¹	180
LF 60/14	1400	400	400	400	60	790	1080	1370	12.0	3-phase	270
LF 120/14	1400	500	500	500	120	890	1180	1470	18.0	3-phase	370

¹Heating only between two phases

*Please see page 73 for more information about supply voltage

²External dimensions vary when furnace is equipped with additional equipment. Dimensions on request



Parallel swinging door for opening when hot

Protective Gas Boxes for Models LH 15/.. - LH 216/..

Due to the cubic interior of the LH chamber furnaces and the corresponding protective gas boxes, these furnaces are ideally suited for higher batches. Gassing boxes for the LH models have a standard charge thermocouple, which can be used, for example, for charge control. The protective gas inlet and outlet is routed through the furnace collar in the case of a furnace with a swivel door on the left and through the lower furnace collar in the lift-door configuration.

These boxes have a lid for charging from above, protective gas inlet and outlet.



Protective gas box for furnaces with hinged door

- Tmax 1100 °C
- For non-combustible protective and reactive gases argon, nitrogen and forming gas (observe national regulations)
- Protective gas box with fiber seal and cover with locks, inert gas introduction via a pipe into the bottom of the box
- Protective gas connection via quick coupling with hose connector (inner diameter 9 mm)
- Piping for gas inlet and outlet through the furnace collar
- Heat-resistant alloy 314 (AISI)/(DIN material no. 1.4841)
- Charge thermocouple type K for temperature display or charge control

Additional equipment

- Starting from LH 30/.. a charging cart is recommended see page 54
- Digital temperature display see page 51
- Gas supply systems see page 52
- Extended gas piping for the use of smaller boxes in larger furnace models
- Draw hook
- Charging stacker see page 55

Article no.	Furnace	Inner dimensions in mm			Outer dimensions in mm ¹			Charging method of the box
		w	d	h	W	D	H	
631001276	LH 15/..	100	100	100	165	182	166	draw hook
631001277	LH 30/..	170	170	170	235	252	236	draw hook
631001278	LH 60/..	250	250	250	315	332	316	draw hook
631001279	LH 120/..	350	350	350	415	411	441	draw hook
631001280	LH 216/..	450	450	400	514	535	554	charging stacker

Article no. 601655055, 1 set of fiber insulation cord, 5 strips of 610 mm each

Work space = box inner dimensions: - 30 mm to all sides

Larger boxes and custom dimensions available upon request

¹ Without piping

Protective Gas Boxes with Charging from the Front

Design as the described protective gas boxes, but with charging from the front. These protective gas boxes remain in the oven and are equipped with a lid that can be opened to the front. After the lid has been opened, the batch can be removed directly.



Protective gas box which stays in the furnace

Article no.	Furnace	Inner dimensions in mm			Outer dimensions in mm ¹			Charging method of the box
		w	d	h	W	D	H	
631001310	LH 15/..	100	100	100	170	148	194	-
631001311	LH 30/..	170	170	170	240	218	264	-
631001312	LH 60/..	250	250	250	320	298	344	-
631001313	LH 120/..	350	350	350	420	398	444	-

Article no. 601655055, 1 set of fiber insulation cord, 5 strips of 610 mm each

Work space = box inner dimensions: - 30 mm to all sides

Larger boxes and custom dimensions available upon request

¹ Without piping

Protective Gas Boxes with Evacuation Lid for Models LH 15/.. - LH 216/..

Design as the described protective gas boxes, but with an additional evacuation lid. In order to reduce the residual oxygen in the box, protective gas boxes with evacuation lids can be used. These boxes have a lid for top loading, a protective gas inlet and outlet, and an evacuation cover with rubber gasket. The gas piping and the handling in the warm state corresponds to the gassing boxes on page 32. In addition, a connection for a vacuum pump via three-way ball valve is provided.

In combination with a vacuum pump, the oxygen is evacuated from the box in cold state and afterwards flushed with protective gas. Repeating the process once or several times will significantly improve the results. After this process, the evacuation cover is removed and the actual heat treatment process is started under protective gas. After the heat treatment, the box is pulled out of the furnace and can be cooled in air or opened for batch removal.

- Protective gas box with fiber sealing and lid with locks, recess for evacuation lid, gas inlet via a pipe into the bottom of the box
- Evacuation lid with rubber sealing (Elastomer) and manometer
- Protective gas connection via threeway ball valve and quick coupling with hose connector (inner diameter 9 mm)

Additional equipment

- Starting from LH 30/.. a charging cart is recommended see page 54
- Digital temperature display see page 51
- Vacuum pump see page 53
- Gas supply systems see page 52
- Extended gas piping for the use of smaller boxes in larger furnace models
- Draw hook
- Charging stacker see page 55

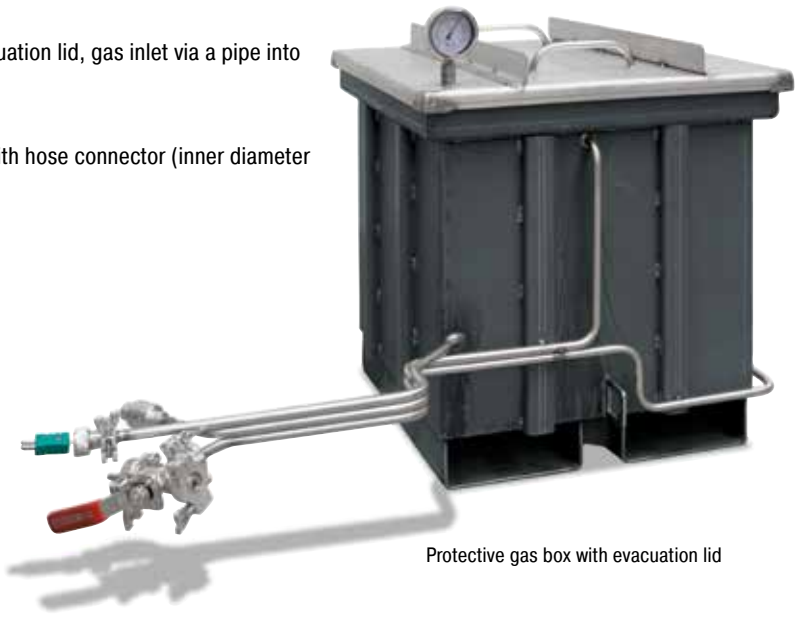

Protective gas box with evacuation lid

Article no.	Furnace	Inner dimensions in mm			Outer dimensions in mm ¹			Charging method of the box
		w	d	h	W	D	H	
631001281	LH 15/..	100	100	100	152	180	160	draw hook
631001282	LH 30/..	170	170	170	222	252	230	draw hook
631001283	LH 60/..	250	250	250	302	332	310	draw hook
631001284	LH 120/..	350	350	350	402	432	405	draw hook
631001285	LH 216/..	450	450	400	506	535	540	charging stacker

Article no. 601655055, 1 set of fiber insulation cord, 5 strips of 610 mm each ¹ Without piping and evacuation lid
 Work space = box inner dimensions: - 30 mm to all sides
 Larger boxes and custom dimensions available upon request

Charging Plates for Models LH 15/.. - LH 216/..

Charging plates are recommended to protect the furnace floor. The charging plates are particularly suitable for heat treatment with protective gas boxes in order to minimize wear during charging.

- Tmax 1100 °C
- Threeside upstand
- Heat-resistant alloy 314 (AISI)/(DIN material no. 1.4841)
- With spacer o the rear heating elements



Charging plate

Article no.	Furnace	Outer dimensions in mm		
		W	D	H
628002013	LH 15/..	190	230	30
628002014	LH 30/..	260	300	30
628002015	LH 60/..	340	400	30
628002016	LH 120/..	440	500	30
628002017	LH 216/..	540	600	30

Chamber Furnaces with Drawer Bottom or as a Bogie



Chamber furnace NW 440 with free traversing bogie

The NW chamber furnaces enable simple charging for cold-cold processes. The heat treatment can take place under air or under non-flammable protective gases with a protective gas box or protective gas hood. With a drawer mechanism (NW 150 - NW 300/H) the furnace table can be easily pulled out of the chamber furnace. The larger models NW 440 - NW 1000/H are designed as shuttle furnace with completely free traversing bogie. Free access in front of the furnace allows for a simplified and clear charging.

- Tmax 1300 °C, 1100 °C with protective gas box (additional equipment)
- Dual shell housing, galvanized steel sheets
- Double-walled door with front made of textured stainless steel
- Controller mounted on furnace door and removable for comfortable operation (up to model NW 440)
- Heating from five sides with special arrangement of heating elements for optimum temperature uniformity
- Heating elements of support tubes provide for free radiation of the heat
- Multi-layer insulation with light-weight refractory bricks and high-quality, energy-saving backing insulation

- Exclusive use of insulation materials without categorization according to EC Regulation No 1272/2008 (CLP). This explicitly means that alumino silicate wool, also known as "refractory ceramic fiber" (RCF), which is classified and possibly carcinogenic, is not used.
- Vaulted ceiling
- Furnace table can be pulled-out as drawer (NW 150 - NW 300)
- From chamber furnace NW 440 bogie on four castors (two with brakes) which can be pulled out completely. Accession assistance and removable drawbar for bogie
- SiC-floor plate protects floor elements and provides a level setting surface
- Door sealing grinded by hand (brick on brick); NW 150 - NW 300
- Semi-automatic air inlet flap closes the air inlet at a temperature which can be set in the controller for NW 150 - NW 300
- Exhaust air outlet in the ceiling, motorized exhaust air flap for chamber furnaces NW 440 - NW 1000
- Comfortable charging height with base of 800 mm (chamber furnaces NW 440 - NW 1000 = 500 mm)
- Defined application within the constraints of the operating instructions
- NTLog for Nabertherm controller: recording of process data with USB-flash drive
- Controls description see page 72



Chamber furnace NW 300 with pulled-out furnace table

Additional equipment

- Protective gas boxes and hoods
- Manual or automatic gas supply system
- Process control and documentation via VCD software package or Nabertherm Control Center (NCC) for monitoring, documentation and control see page 72

Model	Tmax °C	Inner dimensions in mm			Volume in l	Outer dimensions ¹ in mm			Connected load kW	Electrical connection*	Weight in kg
		w	d	h		W	D	H			
NW 150	1300	430	530	620	150	790	1150	1600	11.0	3-phase	400
NW 200	1300	500	530	720	200	860	1150	1700	15.0	3-phase	460
NW 300	1300	550	700	780	300	910	1320	1760	20.0	3-phase	560
NW 440	1300	600	750	1000	450	1000	1400	1830	30.0	3-phase	970
NW 660	1300	600	1100	1000	660	1000	1750	1830	40.0	3-phase	1180
NW 1000	1300	800	1000	1250	1000	1390	1760	2000	57.0	3-phase	1800

*Please see page 73 for more information about supply voltage

¹External dimensions vary when furnace is equipped with additional equipment. Dimensions on request.

Protective Gas Boxes and Protective Gas Hoods for Chamber Furnaces NW 150 - NW 1000

Protective Gas Boxes

These protective gas boxes have a cover with a sealing profile as well as a protective gas inlet and outlet. They are pulled out of the furnace in cold condition and charged from above.

- Tmax 1100 °C
- For non-combustible protective and reactive gases argon, nitrogen and forming gas (observe national regulations)
- Protective gas box with fiber seal and cover with locks, inert gas introduction via a pipe into the bottom of the box
- Protective gas connection via quick coupling with hose connector (inner diameter 9 mm)
- Piping for gas inlet and outlet through the furnace collar
- Forklift receptive
- Heat-resistant alloy 314 (AISI)/(DIN material no. 1.4841)
- Charge thermocouple type K for temperature display or charge control

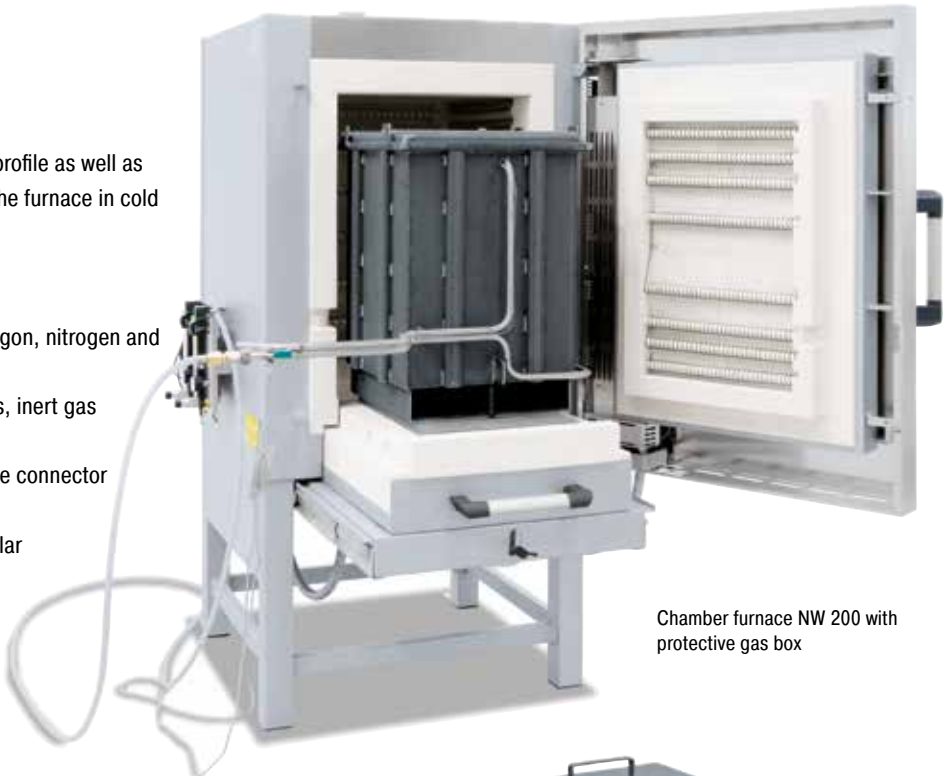

Chamber furnace NW 200 with protective gas box

Protective Gas Hoods

Protective gas hoods consist of a top and a bottom with a sealing profile as well as protective gas inlet and outlet. After charging the bottom in front of the oven in cold condition, the hood is put on and the drawer or the car is pushed back into the oven.

Design as protective gas boxes, but

- Gassing hood with eye for raising the hood by crane
- Hood bottom with sealing
- Piping for gas inlet and outlet at the hood through the furnace collar

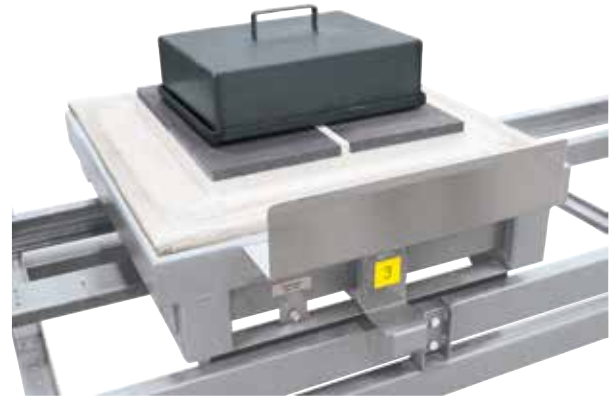

Protective gas box for similar furnace

Additional equipment for protective gas boxes and hoods

- Digital temperature display see page 51
- Gas supply systems see page 52



Two automatic gas supply systems, connected with each other

Furnace	Article no. Protective gas box	Inner dimensions in mm		
		w	d	h
NW 150	631001329	330	420	400
NW 200	631001330	400	420	500
NW 300	631001331	450	550	550
NW 440	631001332	500	600	750
NW 660	631001333	500	750	750
NW 1000	on request			

Article no. 601655055, 1 set of fiber insulation cord, 5 strips of 610 mm each
 Work space = box inner dimensions: - 30 mm to all sides
 Larger boxes and custom dimensions available upon request

Article no. Protective gas hood	Inner dimensions in mm			Charging the furnace
	w	d	h	
631001334	300	360	400	Drawer
631001335	370	360	450	Drawer
631001336	420	530	500	Drawer
631001337	470	580	550	On a bogie
631001338	470	750	550	On a bogie
	on request			On a bogie

Chamber Furnaces Electrically Heated



Chamber furnace N 41/H



Chamber furnace N 321 with
charging stacker

These universal chamber furnaces with radiation heating have been specifically designed to withstand heavy-duty use in the tool shop. They are particularly useful for processes such as tool making or for hardening jobs, e.g. annealing, hardening and forging. With help of various accessories, these furnaces can be customized to your application requirements.

- Compact, robust design
- Deep furnace chamber with three-sides heating: from both side walls and bottom
- Heating elements on support tubes ensure free heat radiation and a long service life
- Bottom heating protected by heat conducting SiC tiles
- Stainless steel upper door jamb protects furnace structure when furnace is opened hot
- Base frame included in the delivery, N 7/H - N 17/HR designed as table-top model
- Exhaust opening in the side of the furnace, or on rear wall of chamber furnace in the N 31/H models and higher
- Temperature uniformity up to +/- 10 °C according to DIN 17052-1 see page 68
- Low energy consumption due to multi-layer insulation
- Gas spring dampers provide for easy door opening and closing
- Heat resistant zinc paint for protection of door and door frame (for model N 81 and larger)
- Defined application within the constraints of the operating instructions
- NTLog Basic for Nabertherm controller: recording of process data with USB-flash drive
- Controls description see page 72



Annealing furnace N 7/H, as table-top
model

For additional features see separate catalog „Thermal Process Technology I“

Model	Tmax °C	Inner dimensions in mm			Volume in l	Outer dimensions ⁴ in mm			Heating power in kW ³	Electrical connection*	Weight in kg
		w	d	h		W	D	H			
N 7/H ¹	1280	250	250	140	9	800	650	600	3.0	1-phase	60
N 11/H ¹	1280	250	350	140	11	800	750	600	3.5	1-phase	70
N 11/HR ¹	1280	250	350	140	11	800	750	600	5.5	3-phase ²	70
N 17/HR ¹	1280	250	500	140	17	800	900	600	6.4	3-phase ²	90
N 31/H	1280	350	350	250	30	1040	1100	1340	15.0	3-phase	210
N 41/H	1280	350	500	250	40	1040	1250	1340	15.0	3-phase	260
N 61/H	1280	350	750	250	60	1040	1500	1340	20.0	3-phase	400
N 87/H	1280	350	1000	250	87	1040	1750	1340	25.0	3-phase	480
N 81	1200	500	750	250	80	1140	1900	1790	20.0	3-phase	820
N 161	1200	550	750	400	160	1180	1930	1980	30.0	3-phase	910
N 321	1200	750	1100	400	320	1400	2270	2040	47.0	3-phase	1300
N 641	1200	1000	1300	500	640	1690	2670	2240	70.0	3-phase	2100
N 81/13	1300	500	750	250	80	1220	1960	1840	22.0	3-phase	900
N 161/13	1300	550	750	400	160	1260	1990	2030	35.0	3-phase	1000
N 321/13	1300	750	1100	400	320	1480	2330	2090	60.0	3-phase	1500
N 641/13	1300	1000	1300	500	640	1770	2730	2290	80.0	3-phase	2500

¹Table-top model

²Heating only between two phases

⁴External dimensions vary when furnace is equipped with additional equipment. Dimensions on request.

*Please see page 73 for more information about supply voltage

³Depending on furnace design connected load might be higher

Protective Gas Boxes for Models N 7/H - N 641/13

The annealing boxes for heat treatment under protective gas are equipped with a protective gas inlet and outlet. A box with protective gas is advisable for larger workpieces requiring defined heat treating. We would be pleased to carry out Trials at our technical center can be carried out on request. Up to furnace model N 61/H with downward door opening the gas ductway is laid through the upper section of the door collar, for larger furnaces with upward door opening the supply line is laid through the lower furnace collar.

The box is pressurized with non flammable protective and reactive gases such as argon, nitrogen or forming gas via the protective gas tube. There are manual and automatic systems available for protective gas. See pages 52 - 53. for more information about protective gases which can be used as well as manual and automatic protective gas systems.

After charging the box it is closed and preflushed outside the furnace. Afterwards the box is placed in the preheated furnace. The quantity of gas can be reduced to the process flush quantity. After the heat treatment the box is pulled out of the furnace, the charge taken from the box and placed in the quenching medium. We recommend using binding wire on the parts so that they can easily be grasped by tongs.

A flexible type K thermocouple is installed in the box for measuring the temperature; we recommend connecting it to a digital display device or to a temperature recorder.

The box can also be cooled down on a cooling platform while closed. Be sure that the protective gas flowrate is increased for this application.

- Tmax 1100 °C
- For non-combustible protective and reactive gases argon, nitrogen and forming gas (observe national regulations)
- Protective gas box with fiber sealing and lid, gas supply via a tube into the bottom of the box
- Protective gas connection via quick coupling with hose connector (inner diameter 9 mm)
- Piping for gas inlet and outlet through the furnace collar
- Heat-resistant alloy 314 (AISI)/(DIN material no. 1.4841)
- Charge thermocouple type K for temperature display or charge control

Additional equipment

- Starting from N 31/H a charging cart is recommended see page 54
- Digital temperature display see page 51
- Gas supply systems see page 52
- Charging forks see page 39
- Draw Hook



Box with protective gas connection



N 7/H



Winch stacker with protective gas box and furnace

Article no.	Furnace	Inner dimensions in mm			Outer dimensions in mm ¹			Preflush rate l/min	Process flush rate l/min	Charging method of the box
		w	d	h	W	D	H			
631000963	N 7/H	180	190	90	216	226	116	15 - 20	5 - 8	charging fork
631000968	N 11/H, N 11/HR	180	290	90	216	326	116	15 - 20	5 - 8	charging fork
631000973	N 17/HR	180	440	90	216	476	116	15 - 20	5 - 8	charging fork
631000978	N 31/H	280	230	200	316	304	226	20 - 25	10 - 15	draw hook
631000983	N 41/H	280	380	200	316	454	226	20 - 25	10 - 15	draw hook
631000987	N 61/H, N 87/H	280	500	200	316	574	226	20 - 25	10 - 15	draw hook
631000392	N 81, N 81/13	394	494	185	462	530	212	20 - 30	10 - 20	charging stacker
631000393	N 161, N 161/13	450	550	250	515	596	355	20 - 30	10 - 20	charging stacker
631000607	N 321, N 321/13	470	850	185	580	960	330	20 - 30	10 - 20	charging stacker
631000608	N 641, N 641/13	720	1050	270	830	1160	414	20 - 30	10 - 20	charging stacker

Article no. 601655055, 1 set of fiber insulation cord, 5 strips of 610 mm each
 Work space = box inner dimensions: - 30 mm to all sides
 Larger boxes and custom dimensions available upon request

¹ Without piping

Protective Gas Boxes with Evacuation Lid for Models N 7/H - N 161/13

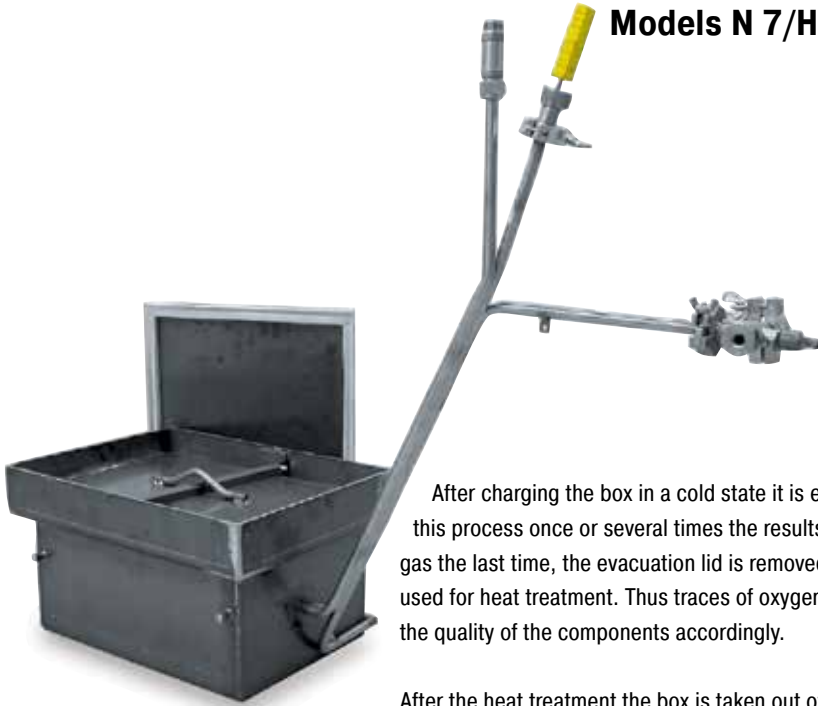

Protective gas box for N 41/H furnace with additional evacuation lid

For heat treatment of bulk goods and hollow parts under protective gas atmosphere we recommend the usage of protective gas boxes with an additional evacuation lid.

These boxes are equipped with a lid for top charging, protective gas inlet and outlet as well as a evacuation lid with rubber sealing gasket. Gas ductwork and handling while hot is the same as the protective gas boxes described on page 37. In addition, these boxes also feature a connection for a vacuum pump with a shut-off valve.

After charging the box in a cold state it is evacuated and afterwards flushed with protective gas. By repeating this process once or several times the results are considerably improved. After the box was flushed with protective gas the last time, the evacuation lid is removed and the box is placed into the preheated furnace. Protective gas is used for heat treatment. Thus traces of oxygen in the box can be reduced by a considerable amount which improves the quality of the components accordingly.

After the heat treatment the box is taken out of the furnace and can be cooled in air or be opened to remove the charge.

The box can also be force-cooled on a cooling platform while closed. Be sure that the protective gas flowrate is increased for this application.

- Tmax 1100 °C
- For non-combustible protective and reactive gases argon, nitrogen and forming gas (observe national regulations)
- Protective gas box with fiber sealing and lid with locks, recess for evacuation lid, gas inlet via a pipe into the bottom of the box
- Evacuation lid with rubber sealing (Elastomer) and manometer
- Protective gas connection via threeway ball valve and quick coupling with hose connector (inner diameter 9 mm)
- Piping for gas inlet and outlet through the furnace collar
- Heat-resistant alloy 314 (AISI)/(DIN material no. 1.4841)
- Charge thermocouple type K for temperature display or charge control

Additional equipment

- Starting from N 31/H a charging cart is recommended see page 54
- Digital temperature display see page 51
- Vacuum pump see page 53
- Gas supply systems see page 52
- Charging forks see page 39
- Draw Hook

Article no.	Furnace	Inner dimensions in mm			Outer dimensions in mm ¹			Preflush rate l/min	Process flush rate l/min	Charging method of the box
		w	d	h	W	D	H			
631000966	N 7/H	170	170	70	212	212	106	15 - 20	5 - 8	charging fork
631000971	N 11/H, N 11/HR	170	270	70	212	312	106	15 - 20	5 - 8	charging fork
631000976	N 17/HR	170	420	70	212	462	106	15 - 20	5 - 8	charging fork
631000981	N 31/H	250	200	150	292	242	178	20 - 25	10 - 15	draw hook
631000985	N 41/H	250	350	150	292	392	178	20 - 25	10 - 15	draw hook
631000989	N 61/H, N 87/H	250	500	150	292	542	178	20 - 25	10 - 15	draw hook
631000526	N 81, N 81/13	354	494	185	422	905	215	20 - 30	10 - 20	charging stacker
631000527	N 161, N 161/13	400	550	250	468	965	350	20 - 30	10 - 20	charging stacker

Article no. 601655055, 1 set of fiber insulation cord, 5 strips of 610 mm each
Work space = box inner dimensions: - 30 mm to all sides

¹ Without piping and evacuation lid
Larger boxes and custom dimensions available upon request

Charging Plates for Models N 7/H - N 641/13

We recommend these accessories for applications up to 1100 °C to protect the furnace floor, especially if a charging cart is used.

- Tmax 1100 °C
- Three raised edges
- Heat-resistant alloy 314 (AISI)/(DIN material no. 1.4841)
- Larger plates and custom dimensions available upon request



Charging plate

Article no.	Furnace	Outer dimensions in mm		
		W	D	H
628000138	N 7/H	240	290	25
628000139	N 11/H, N 11/HR	240	390	25
628000141	N 17/HR	240	540	30
628000400	N 31/H	340	390	30
628000133	N 41/H	340	540	30
628000142	N 61/H	340	790	30
628001925	N 87/H	340	1040	30
628000143	N 81, N 81/13	480	790	30
628000144	N 161, N 161/13	530	790	30
628000145	N 321, N 321/13	720	1140	30
628000146	N 641, N 641/13	950	1330	30

Charging Forks



- Charging forks to charge and remove protective gas boxes up to model N 17/H

Article no.	Furnace
631001016	N 7/H, N 11/H(R)
631001017	N 17/HR

Tool Shop Hardening Systems MHS 31, MHS 41 and MHS 61



These toolshop hardening systems are suitable for components in air or under a protective gas atmosphere. They can be assembled from a chamber furnace, a forced convection furnace, a protective gas box with a gas supply via a solenoid valve, a charging plate to floor, and a quenching bath with heating element. During the heat treatment under protective gas, the process starts with the flushing of the batch in the protective gas box by means of protective gas. Subsequently, annealing is carried out in the chamber furnace at a lower process flushing rate. The chamber furnace is opened after the annealing process and the batch is removed from the protective gas box to be quenched in the preheated quench bath. The final annealing process takes place in the forced convection furnace. For easier charging, we recommend the use of optional charging aids such as pull hooks and charging trolleys.

hardening larger components. The systems can be assembled from a chamber furnace, a protective gas box, a forced convection furnace, a protective gas box with a gas supply via a solenoid valve, a charging plate to floor, and a quenching bath with heating element.

The toolshop hardening systems are an assembly of furnaces and accessories from our standard range. All components can also be ordered separately.

Additional equipment

- Draw hook
- Charging cart see page 54

	Model	Tmax °C	Inner dimensions in mm			Charging height in mm	Outer dimensions in mm			Heating power in kW ²	Electrical connection*	Weight in kg
			w	d	h		W	D	H			
MHS 31	N 31/H	1280	350	350	250	900	1040	1100	1340	15	3-phase	210
	NA 30/65	650	290	420	260	900	870	1290	1385	5	3-phase ¹	285
	Quenching bath Q 50	-	200	170	-	700	350	350	700	-	-	-
	Heating element	-	-	-	-	-	-	-	-	3	1-phase	-
MHS 41	N 41/H	1280	350	500	250	900	1040	1250	1340	15	3-phase	260
	NA 60/65	650	350	500	350	900	910	1390	1475	9	3-phase	350
	Quenching bath Q 50	-	200	170	-	700	350	350	700	-	-	-
	Heating element	-	-	-	-	-	-	-	-	3	1-phase	-
MHS 61	N 61/H	1280	350	750	250	900	1040	1500	1350	20	3-phase	400
	NA 60/65	650	350	500	350	900	910	1390	1475	9	3-phase	350
	Quenching bath Q 50	-	200	170	-	700	350	350	700	-	-	-
	Heating element	-	-	-	-	-	-	-	-	3	1-phase	-
Accessories	Charging cart CW1	-	-	-	-	880 - 920	330	1100	880 - 920	-	-	-
	Charging cart CWK1	-	-	-	-	880 - 920	330	1100	880 - 920	0,2	1-phase	-
	Side platform	-	600	600	-	900	600	600	900	-	-	-
	Protective gas box N 31/H	1100	280	230	200	-	316	304	226	-	-	-
	Protective gas box N 41/H	1100	280	380	200	-	316	454	226	-	-	-

¹Heating only between two phases

²Depending on furnace design connected load might be higher

*Please see page 73 for more information about supply voltage

Protective Gas Hardening System SHS 41

This compact, semi-automatic system is suitable for hardening in a protective gas atmosphere followed by quenching of the workpiece in oil. In this way, even larger parts can be annealed under a protective gas and quenched. It consists of a chamber furnace N 41/H hardening furnace with a pneumatic door opening and charging plates as well as an oil quench bath on rollers with an integrated pneumatic lowering unit, a floor grid with gas hood, a holding unit for the gas hood as well as a rim exhaust with flame trap.

The workpiece is placed on the floor grid and covered with the gas hood. After preflushing with protective gas, the gas hood is pushed with the floor grid into the chamber furnace. After the heat treatment is completed, the workload is pulled out of the furnace onto the lowering unit. The hood remains above the quenching bath while the charging floor grid is lowered pneumatically. In order to obtain best quenching results, the pneumatic lowering unit is moved up and down in the oil quench bath. After completion, the workload is moved into unloading position.

This low cost system can be used for hardening processes which otherwise could only be handled in complex furnace systems.



Protective gas hardening system with furnace N 41/H

- Chamber furnace N 41/H
- Pneumatic pedal switch operated door opening
- Charging plate
- Oil quench bath on rollers
- Pneumatic lowering unit
- Heating of oil quench bath
- Oil temperature display
- Charging floor grid and gas hood
- Holding unit for gas hood
- Manual protective gas unit see page 52
- Draw hook
- Safety equipment consisting of rim exhaust with flame trap and oil steam separator

Additional equipment

- Suction hood
- Water bath



Furnace Model	Tmax °C	Inner dimensions in mm			Volume in l	Outer dimensions in mm			Heating power in kW ²	Electrical connection*	Weight in kg
		w	d	h		W	D	H			
N 41/H ¹	1280	350	500	250	40	1040	1250	1340	15.0	3-phase	260

¹Furnace description see page 36

²Please see page 73 for more information about supply voltage

²Depending on furnace design connected load might be higher

Article no.	Protective gas hardening system	hood size in mm			Oil quench bath size in liters	max. load Weight	max. quench yield/h	Preflush rate	Process flush rate	Heating power oil bath/kW	Electrical connection*
		W	D	H							
-	SHS 41	260	360	180	400	25 kg	20 kg	20 - 25	10 - 15	6.0	3-phase
631006104	Gas hood (spare part)										

*Please see page 73 for more information about supply voltage

Air Circulation Chamber Furnaces, Electrically Heated Also for Debinding in Air and under Protective Gases



Forced convection chamber furnace NA 250/45



Forced convection chamber furnace NA 120/45



Air circulation chamber furnace NA 120/45 DB10 for debinding in air

Chamber furnaces with air circulation are characterized particularly by their very good temperature uniformity. As a result, they are well suited for processes such as calcination and drying e.g. ceramic materials. The design as a debinding furnace for safe debinding in air or in an inert atmosphere is possible. When used for debinding in air the exhaust gases are diluted by fresh air to reliably prevent an inflammatory atmosphere in the furnace chamber. For debinding processes that have to take place under inert gas, the IDB passive safety concept with a residual oxygen content of max. 3 % is recommended.

- Tmax 450 °C, 650 °C, or 850 °C
- Stainless steel air-baffles in the furnace for optimum air circulation
- Swing door hinged on the right side
- Base frame included in the delivery, NA 15/65 designed as table-top model
- Horizontal air circulation
- Temperature uniformity up to +/- 4 °C according to DIN 17052-1 (model NA 15/65 up to +/- 5 °C) see page 68
- Optimum air distribution enabled by high flow speeds
- One frame sheet and rails for two additional trays included in the scope of delivery (NA 15/65 without frame sheet)
- Defined application within the constraints of the operating instructions
- NTLog Basic for Nabertherm Controller: Recording of process data with USB-flash drive (NA 30/45 - N 675/85 HA)
- Controls description see page 72

Additional equipment (not for model NA 15/65)

- Optimization of the temperature uniformity up to +/- 3 °C according to DIN 17052-1 see page 68
- Air inlet and exhaust air flaps when used for drying
- Controlled cooling with fan
- Manual lift door (up to model N(A) 120/.. (HA))
- Pneumatic lift door



Air circulation chamber furnace N 250/65 HA IDB with gas supply box for debinding and protective gases

Air circulation chamber furnace N 500/65 HA DB200 for debinding in air with catalytic afterburner system

- Air circulation with speed control, recommendable for processes with light or sensitive charge
- Additional frame sheet
- Roller conveyor in furnace chamber for heavy charges
- Designed for Tmax 950 °C
- Safety technology according to EN 1539 (NFPA 86) (models NA .. LS) for charges containing solvents
- Inlets, measuring frames and thermocouples for TUS measurements charge or comparative measurements
- Process control and documentation via VCD software package or Nabertherm Control Center (NCC) for monitoring, documentation and control see page 72

Model	Tmax °C	Inner dimensions in mm			Volume in l	Outer dimensions ⁶ in mm			Heating power in kW ³ NA/NA .. LS	Electrical connection*	Weight in kg	Heat-up time ⁵ to Tmax in minutes	Cool-down time ⁵ from Tmax to 150 °C in minutes	
		w	d	h		W	D	H					Flaps ⁴	Fan cooling ⁴
NA 30/45(LS)	450	290	420	260	30	1040	1290	1385	3.0 / 9.0	1(3)-phase	285	120	120	30
NA 60/45(LS)	450	350	500	350	60	1100	1370	1475	6.0 / 12.0	3-phase	350	120	240	30
NA 120/45(LS)	450	450	600	450	120	1250	1550	1550	9.0 / 18.0	3-phase	460	60	240	30
NA 250/45(LS)	450	600	750	600	250	1350	1650	1725	12.0 / 24.0	3-phase	590	60	120	30
NA 500/45(LS)	450	750	1000	750	500	1550	1900	1820	18.0 / 24.0	3-phase	750	60	240	30
NA 675/45(LS)	450	750	1200	750	675	1550	2100	1820	24.0 / 30.0	3-phase	900	90	270	60
NA 15/65 ¹	650	295	340	170	15	470	790	460	2.8	1-phase	60	40	-	-
NA 30/65	650	290	420	260	30	870	1290	1385	6.0	3-phase ²	285	120	270	60
NA 60/65	650	350	500	350	60	910	1390	1475	9.0	3-phase	350	120	270	60
NA 120/65	650	450	600	450	120	990	1470	1550	12.0	3-phase	460	60	300	60
NA 250/65	650	600	750	600	250	1170	1650	1680	20.0	3-phase	590	90	270	60
NA 500/65	650	750	1000	750	500	1290	1890	1825	27.0	3-phase	750	60	240	60
NA 675/65	650	750	1200	750	675	1290	2100	1825	27.0	3-phase	900	90	270	90
N 30/85 HA	850	290	420	260	30	607 + 255	1175	1315	5.5	3-phase ²	195	180	900	90
N 60/85 HA	850	350	500	350	60	667 + 255	1250	1400	9.0	3-phase	240	150	900	120
N 120/85 HA	850	450	600	450	120	767 + 255	1350	1500	13.0	3-phase	310	150	900	120
N 250/85 HA	850	600	750	600	250	1002 + 255	1636	1860	20.0	3-phase	610	180	900	180
N 500/85 HA	850	750	1000	750	500	1152 + 255	1886	2010	30.0	3-phase	1030	180	900	210
N 675/85 HA	850	750	1200	750	675	1152 + 255	2100	2010	30.0	3-phase	1350	210	900	210

¹Table-top model see page 42

²Heating only between two phases

³Depending on furnace design connected load might be higher

*Please see page 73 for more information about supply voltage

⁴Additional equipment

⁵Empty furnace

⁶External dimensions vary when furnace is equipped with additional equipment. Dimensions on request.

Protective Gas Boxes for Models NA 30/45 - N 500/85HA



Protective gas box with insertations



Forced convection chamber furnace N 250/85 HA with protective gas box

For the heat treatment, workpieces are placed in the box, the lid is locked using the sealing locks and flushed with protective gas outside the furnace for some time and then placed in the furnace. Depending on the weight, a charging cart (page 30) is recommended.

Basic Version

- For non-combustible protective and reactive gases argon, nitrogen and forming gas (observe national regulations)
- Protective gas box with fiber seal and cover with locks, inert gas introduction via a pipe into the bottom of the box
- Protective gas connection via quick coupling with hose connector (inner diameter 9 mm)
- Piping for gas inlet and outlet through the furnace collar
- Models N 250/..HA, NA 250/.., N 500/..HA und NA 500/.. will be delivered without bottom frame sheet
- Heat-resistant alloy: 309 (AISI)/(DIN material no. 1.4828)
- Charge thermocouple type K for temperature display or charge control

Additional equipment

- Digital temperature display see page 51
- Gas supply systems see page 52
- Extended gas piping for the use of smaller boxes in larger furnace models
- Draw hook
- Charging cart see page 54



Protective gas box with extended piping for usage in a large furnace model

Article no. (Furnace with hinged door)	Article no. (Furnace with lift door)	Furnace	Inner dimensions in mm			Outer dimensions in mm ¹			Charging method of the box
			w	d	h	W	D	H	
631000410	631000763	NA 30/.., N 30/..HA	220	320	160	282	376	242	draw hook
631000411	631000764	NA 60/.., N 60/..HA	270	420	260	336	460	340	draw hook
631000412	631000765	NA 120/.., N 120/..HA	350	520	340	436	560	430	draw hook
631000413	631000766	NA 250/.., N 250/..HA	480	630	460	546	680	600	charging stacker
631000414	631000767	NA 500/.., N 500/..HA	630	780	610	696	836	760	charging stacker

Article no. 601655055, 1 set of fiber insulation cord, 5 strips of 610 mm each

Work space = box inner dimensions: - 30 mm to all sides

Larger boxes and custom dimensions available upon request

¹ Without piping

Protective Gas Boxes with Evacuation Lid for Models NA 30/45 - N 500/85HA



Design as the boxes described above, but with additional evacuation lid and connection. Before the box is placed in the furnace, in a cold state an evacuation and protective gas atmosphere are alternately generated to force out the oxygen and achieve a pure atmosphere.

- Protective gas box with fiber sealing and lid with locks, recess for evacuation lid, gas inlet via a pipe into the bottom of the box
- Evacuation lid with rubber sealing (Elastomer) and manometer
- Protective gas connection via threeway ball valve and quick coupling with hose connector (inner diameter 9 mm)
- Piping for gas inlet and outlet through the furnace collar

Protective gas box with evacuation lid

Additional equipment

- Digital temperature display see page 51
- Vacuum pump see page 53
- Gas supply systems see page 52
- Extended gas piping for the use of smaller boxes in larger furnace models
- Draw hook
- Charging cart see page 54

Article no. (Furnace with hinged door)	Article no. (Furnace with lift door)	Furnace	Inner dimensions in mm			Outer dimensions in mm ¹			Charging method of the box
			w	d	h	W	D	H	
631000559	631000806	NA 30/.., N 30/..HA	170	300	130	258	388	222	draw hook
631000560	631000807	NA 60/.., N 60/..HA	230	380	220	318	468	297	draw hook
631000561	631000808	NA 120/.., N 120/..HA	330	480	320	418	568	412	draw hook
631000562	631000809	NA 250/.., N 250/..HA	430	580	370	518	668	532	charging stacker
631000563	631000810	NA 500/.., N 500/..HA	560	810	530	648	898	692	charging stacker

Article no. 601655055, 1 set of fiber insulation cord, 5 strips of 610 mm each
 Work space = box inner dimensions: - 30 mm to all sides
 Larger boxes and custom dimensions available upon request

¹ Without piping and evacuation lid

Protective Gas Boxes for Automotive (CQI-9) and Aeronautic (AMS7NADCAP) Norms

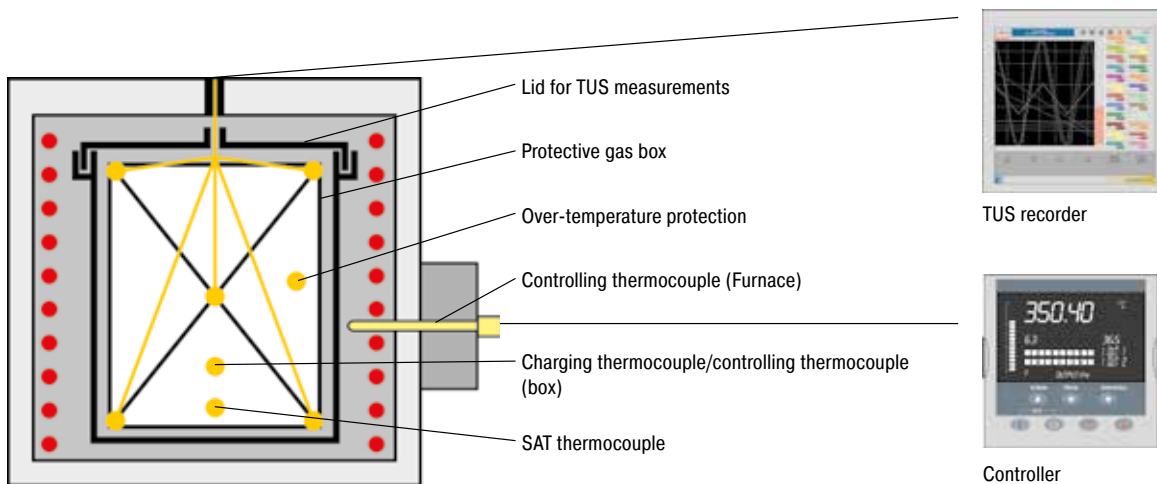

Protective Gas Boxes According to AMS2750F, Instrumentation Type D for Forced Convection Furnaces

These boxes are based on the standard protective gas boxes for furnaces with hinged door. To fulfill AMS2750F, instrumentation, type D requirements the boxes are equipped with necessary measuring ports.

- Temperature uniformity class 2: +/- 5 °C in useful space
- Additional port for customers flexible SAT thermocouple with max. 1,5 mm diameter
- Thermocouple, overtemperature protection, metal clad thermocouple, type N with plug

Article no. (Furnace with swinging door)	(Furnace with lift door)	Furnace	Inner dimensions in mm			Outer dimensions in mm ¹		
			w	d	h	W	D	H
631001020	631001025	NA 30/..., N 30/..HA	220	320	160	282	376	242
631001021	631001026	NA 60/..., N 60/..HA	270	420	260	336	460	340
631001022	631001027	NA 120/..., N 120/..HA	350	520	340	436	560	430
631001023	631001028	NA 250/..., N 250/..HA	480	630	460	546	680	600
631001024	631001029	NA 500/..., N 500/..HA	630	780	610	696	836	760

Article no. 601655055, 1 set of fiber insulation cord, 5 strips of 610 mm each

¹ Without piping

Work space = box inner dimensions: - 30 mm to all sides

Larger boxes and custom dimensions available upon request

Protective Gas Boxes with Evacuation Lid According to AMS2750F, Instrumentation type D

These boxes are based on the standard protective gas boxes with evacuation lid for furnaces with hinged door.

Before the box is placed in the furnace, in a cold state an evacuation and protective gas atmosphere are alternately generated to force out the oxygen and achieve a pure atmosphere.

- Temperature uniformity class 2: +/- 5 °C in useful space
- Additional port for customers flexible SAT thermocouple with max. 1,5 mm diameter
- Thermocouple, overtemperature protection, metal clad thermocouple, type N with plug

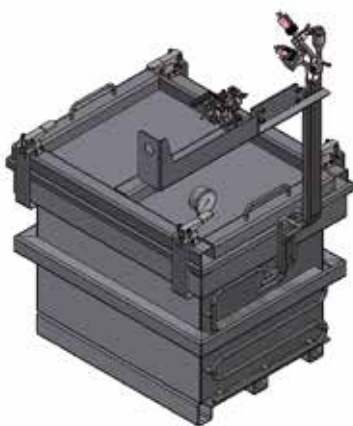

Protective gas box with evacuation lid according to AMS2750F

Article no. (Furnace with hinged door)	(Furnace with lift door)	Furnace	Inner dimensions in mm			Outer dimensions in mm ¹		
			w	d	h	W	D	H
631001049	631001054	NA 30/..., N 30/..HA	170	300	130	258	388	222
631001050	631001055	NA 60/..., N 60/..HA	230	380	220	318	468	297
631001051	631001056	NA 120/..., N 120/..HA	330	480	320	418	568	412
631001052	631001057	NA 250/..., N 250/..HA	430	580	370	518	668	532
631001053	631001058	NA 500/..., N 500/..HA	560	810	530	648	898	692

Article no. 601655055, 1 set of fiber insulation cord, 5 strips of 610 mm each

¹ Without piping

Work space = box inner dimensions: - 30 mm to all sides

Larger boxes and custom dimensions available upon request

Sealed Forced Convection Chamber Furnaces NA-I and NA-SI

Sealed forced convection chamber furnaces are suitable if a heat treatment process up to 650 °C requires a protective gas atmosphere that does not have to be completely oxygen free.

The difference between the two variants is that the I-model only has a sealed outer housing while the SI-model has a welded inner box, which further reduces the residual oxygen concentration.

NA-I design

Like forced convection chamber furnaces < 675 l (page 42) with the following changes

- Tmax 450 °C and 650 °C
- Silicone door seal
- Furnace housing sealed with silicone
- Protective gas connection in the back wall
- Defined application within the constraints of the operating instructions
- Residual oxygen concentration < 1 % depending on the volume and type of protective gas
- For non-flammable protective and reaction gases such as argon, nitrogen, and forming gas (national regulations must be considered)

NA-SI design

Additional features

- Tmax 650 °C
- Welded inner housing
- 2-sided heating and air circulation
- Door sealed with seal gas
- Sealed connection to circulation motor
- Gas inlet via circulator shaft
- Defined application within the constraints of the operating instructions
- Residual oxygen concentration to 0.1 % depending on the volume and type of protective gas
- For non-flammable protective and reaction gases such as argon, nitrogen, and forming gas (national regulations must be considered)



Forced convection chamber furnace NA 120/65 I



Forced convection chamber furnace NA 15/65 I as tabletop model with manual gas supply system

Model	Tmax °C	Inner dimensions in mm			Volume in l	Outer dimensions ⁴ in mm			Heating power in kW ³	Electrical connection*	Weight in kg
		w	d	h		W	D	H			
NA 30/45 I	450	290	420	260	30	1040	1290	1385	3.0	1(3)-phase	285
NA 60/45 I	450	350	500	350	60	1100	1370	1475	6.0	3-phase	350
NA 120/45 I	450	450	600	450	120	1250	1550	1550	9.0	3-phase	460
NA 250/45 I	450	600	750	600	250	1350	1650	1725	12.0	3-phase	590
NA 500/45 I	450	750	1000	750	500	1550	1900	1820	18.0	3-phase	750
NA 675/45 I	450	750	1200	750	675	1550	2100	1820	24.0	3-phase	900
NA 15/65 I ¹	650	295	340	170	15	470	790	460	2.8	1-phase	60
NA 30/65 I	650	290	420	260	30	870	1290	1385	5.0	3-phase ²	285
NA 60/65 I (SI)	650	350	500	350	60	910	1390	1475	9.0	3-phase	350
NA 120/65 I (SI)	650	450	600	450	120	990	1470	1550	12.0	3-phase	460
NA 250/65 I (SI)	650	600	750	600	250	1170	1650	1680	20.0	3-phase	590
NA 500/65 I (SI)	650	750	1000	750	500	1290	1890	1825	27.0	3-phase	750
NA 675/65 I	650	750	1200	750	675	1290	2100	1825	27.0	3-phase	900

¹Table-top model

²Heating only between two phases

*Please see page 73 for more information about supply voltage

³Depending on furnace design connected load might be higher

⁴External dimensions vary when furnace is equipped with additional equipment. Dimensions on request.

Forced Convection Pit-Type Furnaces Electrically Heated



Pit-type furnace SAL 120/65 with protective gas retort box and cooling station next to the furnace

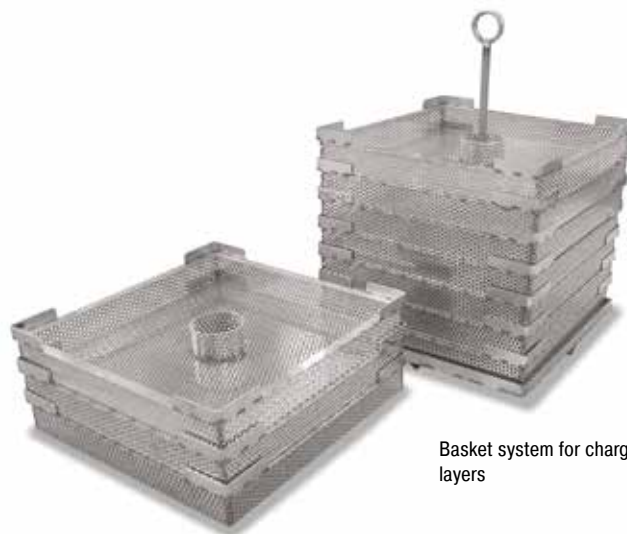

Basket system for charging in different layers

Forced convection pit-type furnaces offer the advantage of easy charging, for heat treatment of heavy parts or loads in charge baskets. With maximum application temperatures available from 450 °C to 850 °C, these compact pit-type furnaces are particularly useful for processes such as tempering, solution annealing, artificial ageing, and soft annealing.

- Tmax 450 °C, 650 °C, 850 °C
- Air circulation fans in the furnace bottom, high circulation rate
- Vertical air circulation with square air heating chamber
- Temperature uniformity up to +/- 4 °C according to DIN 17052-1 see page 68
- Interior walls from stainless steel
- Switchgear with solid-state relays
- Defined application within the constraints of the operating instructions
- NTLog Basic for Nabertherm controller: recording of process data with USB-flash drive
- Controls description see page 72

Additional equipment

- Charging hoist with swivel arm and charge basket
- Optimization of the temperature uniformity up to +/- 2 °C according to DIN 17052-1 see page 68
- Integrated fan for rapid cool down or separate cooling station for annealing box cooling outside of the furnace
- Annealing box with protective gas inlet and outlet for production in a defined atmosphere
- Manual or automatic gas supply systems for non-flammable protective or reaction gases
- Process control and documentation via VCD software package for monitoring, documentation and control see page 72



SAL 250/65



Protective gas box, AMS2750F design

Model	Tmax °C	Inner dimensions in mm			Volume in l	Max. charging weight in kg	Outer dimensions ³ in mm			Heating power in kW ²	Electrical connection*	Weight in kg
		w	d	h			W	D	H			
SAL 30/45	450	300	250	400	30	120	750	850	1250	3.0	1-phase	130
SAL 60/45	450	350	350	500	60	120	800	950	1350	6.0	3-phase	225
SAL 120/45	450	450	450	600	120	120	900	1050	1450	9.0	3-phase	280
SAL 250/45	450	600	600	750	250	400	1050	1200	1600	18.0	3-phase	750
SAL 500/45	450	750	750	900	500	400	1200	1350	1750	27.0	3-phase	980
SAL 30/65	650	300	250	400	30	120	750	850	1250	5.5	3-phase ¹	130
SAL 60/65	650	350	350	500	60	120	800	950	1350	9.0	3-phase	225
SAL 120/65	650	450	450	600	120	120	900	1050	1450	13.0	3-phase	280
SAL 250/65	650	600	600	750	250	400	1050	1200	1600	20.0	3-phase	750
SAL 500/65	650	750	750	900	500	400	1200	1350	1750	30.0	3-phase	980
SAL 30/85	850	300	250	400	30	80	600	740	1000	5.5	3-phase ¹	130
SAL 60/85	850	350	350	500	60	80	800	950	1350	9.0	3-phase	225
SAL 120/85	850	450	450	600	120	80	900	1050	1450	13.0	3-phase	280
SAL 250/85	850	600	600	750	250	250	1050	1200	1600	20.0	3-phase	750
SAL 500/85	850	750	750	900	500	250	1200	1350	1750	30.0	3-phase	980

¹Heating only between two phases

²Depending on furnace design connected load might be higher

³External dimensions vary when furnace is equipped with additional equipment. Dimensions on request.

*Please see page 73 for more information about supply voltage

Charging Aid for Models SAL 30/45 - SAL 500/85

A charging aid, fastened to the furnace consisting of a swivel arm and winch is recommended for charging series SAL 30/45A - SAL 250/85 forced convection pit-type furnaces with protective gas boxes or baskets. This allows easy and safe furnace charging.

- Swivel arm, mounted on side of furnace
- For ease of charging and removal of Nabertherm charging baskets and protective gas boxes
- Winch with hand crank
- Max. charging weight 140 kg

Furnace	Total height in mm
SAL 30/.. - SAL 120/..	2400
SAL 250/..	2600
SAL 500/..	3010



Swivel arm mounted on furnace

Protective Gas Boxes for Models SAL 30/45 - SAL 500/85

For tempering and bright annealing, workpieces are laid in the box, the lid is pressed firmly shut using the sealing locks and flushed with protective gas outside the box for some time and then placed in the furnace. Due to weight reasons we recommend to use a charging aid for charging.

- For non-combustible protective and reactive gases argon, nitrogen and forming gas (observe national regulations)
- Protective gas box with fiber seal and cover with locks, inert gas introduction via a pipe into the bottom of the box
- Protective gas connection via quick coupling with hose connector (inner diameter 9 mm)
- Piping for gas inlet and outlet through the furnace collar
- Heat-resistant alloy: 450 °C - 304 (AISI)/(DIN material no. 1.4301), 650 °C - 321 (AISI)/(DIN material no. 1.4541) or 850 °C - 309 (AISI)/(DIN material no. 1.4828)
- Charging aid lifting eyes
- Charge thermocouple type K for temperature display or charge control



Protective gas box with sealing lock

Additional equipment

- Digital temperature display see page 51
- Gas supply systems see page 52

Article no. with charge thermocouple	Furnace	Inner dimensions in mm			Outer dimensions in mm ¹		
		w	d	h	W	D	H
631000500	SAL 30/45	215	165	277	281	231	354
631000501	SAL 60/45	265	265	377	331	331	454
631000502	SAL 120/45	365	365	477	431	431	554
631000503	SAL 250/45	515	515	627	581	561	704
631000504	SAL 500/45	665	665	727	731	731	804
631000505	SAL 30/65	215	165	277	281	231	354
631000506	SAL 60/65	265	265	377	331	331	454
631000507	SAL 120/65	365	365	477	431	431	554
631000508	SAL 250/65	515	515	627	581	561	704
631000509	SAL 500/65	665	665	727	731	731	804
631000510	SAL 30/85	215	165	277	281	231	354
631000511	SAL 60/85	265	265	377	331	331	454
631000512	SAL 120/85	365	365	477	431	431	554
631000513	SAL 250/85	515	515	627	581	561	704
631000514	SAL 500/85	665	665	727	731	731	804

Article no. 601655055, 1 sales unit of fiber insulation cord, 5 strips of 610 mm each

¹ Without piping

Forced Convection Pit-Type Retort Furnaces up to 850 °C

The forced convection pit-type furnaces of the SAL series (technical data see page 48) can be upgraded by the use of gas tight retorts for processes with defined atmospheres.

These systems are very well suited for the heat treatment of bulk materials.

By means of an additional retort and cooling station, the retort can be removed after completion of the heat treatment process and cooled in a cooling station. In the case of sensitive components, further flushing with protective gas can also be carried out during the cooling phase.

The cooling station can be designed with or without forced cooling by means of a powerful fan.

When equipped with a vacuum pump, the retort is evacuated outside the furnace in cold state and then flushed with protective gas. This procedure is particularly suitable for heat treatment of bulk solids as well as for non-ferrous and precious metals. Residual oxygen is much better and faster removed by means of pre-evacuation.

Up to a maximum working temperature of 600 °C, the furnaces can also be operated under vacuum by connecting a vacuum pump depending on the type of pump, a vacuum of up to 10^{-5} mbar can be achieved.

The furnaces can be equipped with gas supply systems for non-flammable protective and reaction gases, as described on pages 52 - 53.



Pit-type furnace SAL 30/65 with alternating retort for defined inert gas atmosphere and two retort cooling stations

A gas supply system for operation under hydrogen, including safety technology, is also available as an additional equipment.



Retort with vacuum and protective gas line, cooling water connections as well as thermocouples and pressure sensors



Cooling station without forced cooling with exchangeable retort

Temperature Measurement in Gas Supply Systems

The use of a thermometer with thermocouple is recommended for determining the exact heat treatment temperature in protective gas boxes or gas feed annealing bags with holders. The thermocouple is permanently mounted on the respective protective gas boxes or gas feed annealing bag holder. A simple manual thermometer with LCD display or a temperature indicator with LED display can be supplied, mounted in a separate metal housing. Both are equipped with a two-pole plug unit for connecting to the thermocouple. The temperature can be determined in this way and, if necessary, readjusted on the controller.

Upon request, the furnace can be operated by charge control with a thermocouple attached to the workpiece.

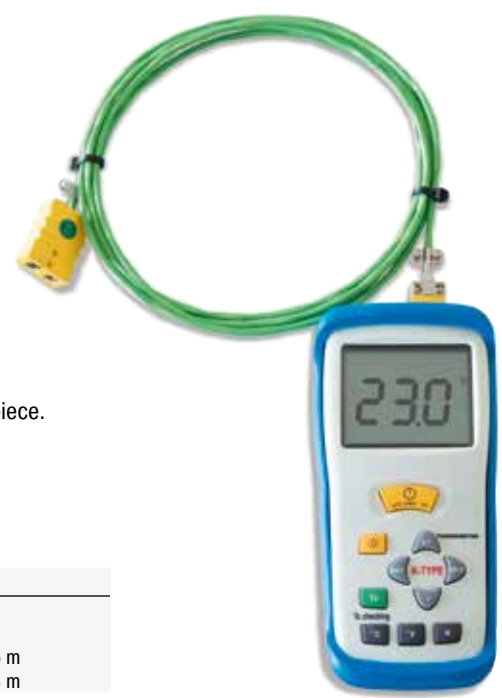

Thermostat (manual device)

Article no.	Description
402000057	Temperature indicator with digital display, 230 V 1/N connection, in metal housing
542100028	Temperature indicator with digital display, battery-operated, manual device
V000808	Connecting cable between heat treatment with charge thermocouple and Article no. 402000057, 5 m
V000801	Connecting cable between heat treatment with charge thermocouple and Article no. 542100028, 3 m

TUS Measuring Frame for Protective Gas Box



To carry out the temperature uniformity measurement (TUS) the protective gas box will be equipped with a second lid. The TUS measuring frame is fixed to the lid and it is equipped with measuring port for thermocouples.

- Tmax 1100 °C
- Useful for all relevant TUS norms
- Under the assumption that the furnace is equipped with a measuring port for themocouples
- Heat-resistant alloy 314 (AISI)/(DIN material no. 1.4828)
- Thermocouples not included

TUS Measuring Frame for Protective Gas Box

Gas Supply Systems

Protective Gases

Protective gases are used to force oxygen out of the gas feed boxes mentioned above. Make sure to use protective gases behaving neutrally toward the heat treated part. The protective gases should be inert, meaning no chemical bonding should occur with the workpiece or the furnace and no reactions should be ended.

In many cases, nitrogen is used as protective gas (lighter than air). Our experience shows that nitrogen does not always lead to sufficient results. A longer preflush time must also be used.

Better results are achieved by adding a mixture of nitrogen and adding some hydrogen. Hydrogen acts as a reducing constituent and reacts with the oxygen. This gas mixture is known as forming gas and available in stores. Experience has shown that adding 5 % hydrogen to the nitrogen leads to good results. According to the EU material safety data sheet this mixture is considered as not flammable. National regulations, however, must be observed. This gas can be obtained in premixed form. No measures must be taken in advance to prevent explosions.

If the workpiece has an affinity to hydrogen, argon used as protective gas can lead to good results.

Argon is a gas which is heavier than air. This makes it relatively easy to fill the protective gas containers. Forming gas with added hydrogen (depending on the country law up to a ration of 98/2) is lighter, but it has the advantage of burning at higher temperatures and therefore binds with the oxygen. Even in a cold state, the leaking hydrogen transports the oxygen very easily out of the container.

For gas mixtures with hydrogen or other combustible gases, the valid safety regulations must always be observed. If the mixture is declared as combustible, the furnace, provided it is a gas tight version, can be fitted with a corresponding safety system.

Always make sure that the room is properly ventilated when working with protective gases. Country-specific safety regulations must also be followed.



Manual Gas Feed Fitting for Bottles

- Pressure reducing valve with assembled flow meter and attached pressure gauge indicating the bottle pressure The assembled variable area flow meter ensures good readability of the amount used
- Connection: screw connection for bottle
- Exit: hose connection (inner diameter 9 mm)
- 200 bar intake pressure, 4 bar outlet pressure
- Incl. 4 m connecting hose to the furnace

Pressure reducing valve with assembled flow meter

Article no.	Type of gas	Flow rate l/min
631000309	Ar	0 - 30
631000310	N ₂	0 - 30
631000311	Non-flammable forming gas	0 - 30

Alternative connection threads on request

Gas Feed Fitting with Solenoid Valve

- Solenoid valve mounted on the furnace, controlled using the controller "Extra" function
- Connection: screw connection for bottle
- Exit: hose connection (inner diameter 9 mm)
- 200 bar intake pressure, 4 bar outlet pressure
- Incl. 4 m connecting hose to the furnace
- Available only in combination with furnace or switchgear



Article no.	Type of gas	Flow rate l/min
631000379	Ar	0 - 30
631000380	N ₂	0 - 30
631000381	Non-flammable forming gas	0 - 30

Alternative connection threads on request

Automatic Gas Supply System for two different Flushing Quantities, e.g. high Volume Preflushing and low Volume for ongoing Operation

Consisting of:

- Switching system with 3-step switch for gas inlet Off/Manual/Automatic via "Extra" function of respective controller, timer for switching from large gas quantity to small gas quantity. Gas feed stops at when program quits
- Automatic gas feed panel with pressure reducer, two adjustable flow meters and two solenoid valves, preinstalled conduit and wiring attached to furnace from the side on an assembly plate.
 - Connection: hose connection (inner diameter 9 mm)
 - Exit: hose connection (inner diameter 9 mm)
 - Max. 10 bar intake pressure, max. 300 mbar outlet pressure
 - Incl. connecting hose between furnace and protective gas box or gas connection
 - Available only in combination with furnace or switchgear



Automatic gas supply system for two flushing quantities

Article no.	Type of gas	Flow rate l/min
631000316	Ar	4 - 80
631000200	N ₂	4 - 80
631000315	Non-flammable forming gas	4 - 80

Vacuum Pump

Oil sealed rotary vane vacuum pump for universal use within the low vacuum range. Highly compact and low noise construction. Manometer included in delivery.

- Sliding vane rotary pump with sucking capacity of max. 16 m³/h
- 0,5 mbar absolute
- Connection hose made of stainless steel 2000 mm
- Connector KF16
- Manometer (-1/0.6 bar)



Vacuum pump

Article no.	Outer dimensions in mm			Connections on suction side		Connected load	Supply voltage*	Nominal suction power m ³ h	Suction capacity m ³ h-l
	W	D	H						
601403057	280	315	200	3/4"	1/2" inner thread	0.55 kW	230 V	16	15

*Article no. for other possible supply voltages on request

Cooling Platforms for Models N 17/HR, N 61/H, N 161



Storage platforms are used for forced cooling of mechanical components or annealing boxes outside of the furnace. The platform can also be used for charging the box in front of the furnace.

- Fan with 25 m³/min ambient air

Article no.	Furnace	Outer dimensions in mm			Connected load kW	Supply voltage*	Comments
		W	D	H			
631000429	up to N 17/HR	550	610	760	0.2	230 V	The same as forced cooling system MHS 17
631000529	up to N 61/H	335	1100	880 - 920	0.2	230 V	The same as CWK1 charging trolley see page 54
631000294	up to N 161	700	800	900	0.9	230 V	

*Article no. for other possible supply voltages on request

Charging Devices with and without Cooling Fan for Models N 31/H - N 641/13, N 30/45 HA - N 500/85 HA, LH (LF) 15/.. - LH (LF) 216/..



Charging cart CWK1

Charging Cart CW(K) 1, CW(K) 15 and CW(K) 16

For charging larger workpieces and annealing boxes.

- 4 casters, freely movable
- Equipped with a rack at working height for temporary storage
- Fixing lock for annealing bags (CWK)
- CWK version with cooling fan (0.2 kW, 230 V)

Article no.	Designation	Furnace	Outer dimensions in mm		
			W	D	H
631000528	CW 1	N 31/H, N 41..., N 61..., N 30/..HA, N 60/..HA	330	1100	880 - 920
631001320	CW 15	LH(LF) 15/.. - LH(LF) 60/..	370	1100	760 - 800
631001321	CW 16	LH(LF) 120/.. - LH(LF) 216/..	470	1000	760 - 800
631000529	CWK 1	N 31/H, N 41..., N 61..., N 30/..HA, N 60/..HA	330	1100	880 - 920
631001322	CWK 15	LH(LF) 15/.. - LH(LF) 60/..	370 + 100 ¹	1100	760 - 800
631001323	CWK 16	LH(LF) 120/.. - LH(LF) 216/..	470 + 80 ¹	1100	760 - 800

Art.-No. for NA 30/.. and NA 60/.. on request

¹ Side switch



Charging cart CW 2

Charging Cart CW 2 - CW 4 and CWK 2 - CWK 4

For charging larger workpieces and annealing boxes.

- 2 casters, 2 fixed rollers for heavy loads
- Equipped with a grid at working height for temporary storage
- Furnace locking via pedal lever
- CWK version with cooling fan (0,9 kW, 230 V)

Article no.	Designation	Furnace	Outer dimensions in mm		
			W	D	H
631000530	CW 2	N 81..., N 161..., N 120/..HA	500	1120	880 - 920
631000531	CW 3	N 321..	800	1490	880 - 920 ²
631000468	CW 4	N 641..	1040	1950	880 - 920 ²
631000469	CWK 2	N 81..., N 161..., N 120/..HA	500 + 80 ¹	1120	880 - 920
631000470	CWK 3	N 321..	800 + 80 ¹	1490	880 - 920 ²
631000471	CWK 4	N 641..	1040 + 80 ¹	1950	880 - 920 ²

Art.-No. for NA 120/.. on request

¹ Side switch

*Please see page 73 for more information about supply voltage

² Without holding grip

Charging Cart WS 1

For charging of protective gas and annealing boxes.

- 2 casters, 2 fixed rollers for heavy loads
- With parallel guided lifting mechanism
- Only for boxes with preparation for charging device (standard since 07.2018)
- Will be delivered with drive-in aid for the relevant furnace model
- Guiding track and charging cart can be also ordered separately

Article no.	Designation	Furnace
6000004965	WS 1	N 61/H, N 81, N 60/..HA, N 120/..HA, NA 60/.., NA 120/.., LH 60/.., LH 120/..

Article no. guiding track	Furnace
6000006118	NA 60/..
6000006101	NA 120/..
6000005811	LH 60/..
6000005372	LH 120/..
6000006155	N 61/H
on request	N 81
on request	N 60/..HA
on request	N 120/..HA



Charging Stacker WS 1

Charging Stacker WS 25 - WS 321

- Lifting device with hand winch
- Compact construction with push bar and manual lifting device for easy and safe lifting
- 2 casters, 2 fixed rollers
- Adjustable loading fork width
- Max. charging weight 500 kg
- Guiding track, mounted at the furnace base frame
- Guiding track and forklift can be also ordered separately

Article no.	Designation	Furnace
631000425	WS 161	N 161..
631000370	WS 321	N 321..
631000299	WS 25	N 250/..HA
631000532	WS 50	N 500/..HA

Art.-No. for NA 250/.. and NA 500/.. on request



WS 50 charging stacker



Guiding track at the base frame

WS 641 Charging Stacker

Design as charging stacker WS 25 - WS 321, but

- Lifting device with manual hydraulic
- Max. charging weight 700 kg

Article no.	Designation	Furnace
631000426	WS 641	N 641..



Charging stacker WS 641 with chamber furnace N 641 and guiding track at the base frame

Ashing Furnaces with Integrated Exhaust Gas Cleaning



Ashing furnace L 40/11 BO

The ashing furnace L ../11 BO is specially designed for processes in which larger sample quantities have to be incinerated. Fields of application are e.g. the ashing of food, thermal cleaning of injection molding tools or the determination of annealing loss. Another application is the debinding of ceramic products, e.g. after additive production.

The ashing furnaces have a passive safety system and integrated exhaust gas post combustion. An exhaust gas fan extracts flue gases from the furnace and simultaneously supplies fresh air to the furnace atmosphere with the result that sufficient oxygen is always available for the incineration process. The incoming air is guided behind the furnace heating and preheated to ensure good temperature uniformity. Exhaust gases are led from the furnace chamber to the integrated post combustion system, where they are postburned and catalytically cleaned. Directly after the incineration process (up to max. 600 °C) a subsequent process up to max. 1100 °C can take place.

- Tmax 600 °C for the incineration process
- Tmax 1100 °C for the subsequent process
- Three-side heating (both sides and bottom)
- Ceramic heating plates with embedded heating wire

- Exclusive use of insulation materials without categorization according to EC Regulation No 1272/2008 (CLP). This explicitly means that aluminosilicate wool, also known as “refractory ceramic fiber” (RCF), which is classified and possibly carcinogenic, is not used.
- Dual shell housing made of structured stainless steel provides for low outer temperature and high stability
- Steel collecting pan protects the bottom insulation
- Spring-assisted closing of the furnace door (flap door) with mechanical locking against unintentional opening
- Thermal/catalytic post combustion, integrated in the exhaust channel, up to 600 °C in function
- Temperature control of post combustion can be set up to 850 °C
- Monitored exhaust air
- Inlet-air preheated through the bottom heating plate
- Over-temperature limiter with adjustable cutout temperature as temperature limiter to protect the oven and load
- Defined application within the constraints of the operating instructions
- NTLog Basic for Nabertherm controller: recording of process data with USB-flash drive
- Controls description see page 72

Additional equipment

- Process control and documentation via VCD software package for monitoring, documentation and control see page 72



Schematic presentation of air circulation in ashing furnace L 24/11 BO

Model	Tmax °C	Inner dimensions in mm			Volume in l	Outer dimensions ² in mm			Max. weight of hydro- carbons in g	Max. evaporation rate g/min	Connected load kW	Electrical connection*	Weight in kg
		w	d	h		W	D	H ¹					
L 9/11 BO	1100	230	240	170	9	415	575	750	75	1.0	7.0	3-phase	60
L 24/11 BO	1100	280	340	250	24	490	675	800	150	2.0	9.0	3-phase	90
L 40/11 BO	1100	320	490	250	40	530	825	800	200	2.5	11.5	3-phase	110

¹Including exhaust tube (Ø 80 mm)

^{*}Please see page 73 for more information about supply voltage

²External dimensions vary when furnace is equipped with additional equipment. Dimensions on request

High-Temperature Furnaces with MoSi₂ Heating Elements up to 1800 °C



High-temperature furnace LHT 01/17 D

Designed as tabletop models, these compact high-temperature furnaces have a variety of advantages. The first-class workmanship using high-quality materials, combined with ease of operation, make these furnaces all-rounders in research and the laboratory. These high-temperature furnaces are also perfectly suited for the sintering of technical ceramics, such as zirconium oxide dental bridges.

- Tmax 1600 °C, 1750 °C, or 1800 °C
- High-quality molybdenum disilicide heating elements
- Dual shell housing made of textured stainless steel sheets with additional fan cooling for low surface temperature
- Exclusive use of insulation materials without categorization according to EC Regulation No 1272/2008 (CLP). This explicitly means that alumino silicate wool, also known as “refractory ceramic fiber” (RCF), which is classified and possibly carcinogenic, is not used.
- Compact design with lift door, opening upwards
- Adjustable air inlet
- Exhaust air opening in the roof
- Type B thermocouple
- Defined application within the constraints of the operating instructions
- NTLog Basic for Nabertherm controller: recording of process data with USB-flash drive
- Controls description see page 72

Additional equipment

- Over-temperature limiter with adjustable cutout temperature as temperature limiter to protect the oven and load
- Square saggars for charging of up to three layers
- Protective gas connection to purge with non-flammable protective or reaction gases
- Manual or automatic gas supply system
- Process control and documentation via VCD software package for monitoring, documentation and control see page 72



High-temperature furnace LHT 01/17 D



Saggars with top lid

Model	Tmax °C	Inner dimensions in mm			Volume in l	Outer dimensions ⁴ in mm			Connected load kW	Electrical connection ¹	Weight in kg	Minutes to Tmax ²
		w	d	h		W	D	H ³				
LHT 02/16	1600	90	150	150	2	470	630	760+260	3.0	1-phase	75	30
LHT 04/16	1600	150	150	150	4	470	630	760+260	5.2	3-phase ¹	85	25
LHT 08/16	1600	150	300	150	8	470	810	760+260	8.0	3-phase ¹	100	25
LHT 01/17 D	1650	110	120	120	1	385	425	525+195	2.2	1-phase	28	10
LHT 03/17 D	1650	135	155	200	4	470	630	760+260	3.0	1-phase	75	60
LHT 02/17	1750	90	150	150	2	470	630	760+260	3.0	1-phase	75	60
LHT 04/17	1750	150	150	150	4	470	630	760+260	5.2	3-phase ¹	85	40
LHT 08/17	1750	150	300	150	8	470	810	760+260	8.0	3-phase ¹	100	40
LHT 02/18	1800	90	150	150	2	470	630	760+260	3.6	1-phase	75	75
LHT 04/18	1800	150	150	150	4	470	630	760+260	5.2	3-phase ¹	85	60
LHT 08/18	1800	150	300	150	8	470	810	760+260	9.0	3-phase ¹	100	60

¹Heating only between two phases

²If connected at 230 V 1/N/PE resp. 400 V 3/N/PE

*Please see page 73 for more information about supply voltage

³Including opened lift door

⁴External dimensions vary when furnace is equipped with additional equipment. Dimensions on request



Over-temperature limiter

High-Temperature Furnaces with Molybdenum Disilicide Heating Elements with Fiber Insulation up to 1800 °C



High-temperature furnace HT 16/18 with gas supply system



High-temperature furnace HT 160/17 with gas supply system



Reinforced floor as protection for bottom insulation for high-temperature furnace HT 16/16 and higher



Inner process top hat with gas injection through the furnace bottom protects the furnace chamber against contamination and/or prevents chemical interaction between the charge and heating elements

Due to their solid construction and compact stand-alone design, these high-temperature furnaces are perfect for processes in the laboratory where the highest precision is needed. Outstanding temperature uniformity and practical details set unbeatable quality benchmarks. For configuration for your processes, these furnaces can be extended with extras from our extensive option list.

- Tmax 1600 °C, 1750 °C, or 1800 °C
- Recommended working temperature 1750 °C (for models HT ../18), increased wear and tear must be expected in case of working at higher temperatures
- Dual shell housing with fan cooling for low shell temperatures
- Heating from both sides via molybdenum disilicide heating elements
- High-quality fiber insulation backed by special insulation
- Side insulation constructed with tongue and groove blocks provides for low heat loss to the outside
- Long-life roof insulation with special suspension
- Exclusive use of insulation materials without categorization according to EC Regulation No 1272/2008 (CLP). This explicitly means that alumino silicate wool, also known as "refractory ceramic fiber" (RCF), which is classified and possibly carcinogenic, is not used.
- Chain-guided parallel swivel door for defined opening and closing of the door
- Two-door design (front/back) for high-temperature furnaces > HT 276/..
- Labyrinth sealing ensures the least possible temperature loss in the door area
- Reinforced floor as protection for bottom insulation as standard from models HT 16/16 upwards
- Vapor vent in the furnace roof
- Heating elements switched via thyristors
- Defined application within the constraints of the operating instructions
- NTLog Basic for Nabertherm controller: recording of process data with USB-flash drive
- Controls description see page 72

Additional equipment

- Uncontrolled or controlled cooling system with frequency-controlled cooling fan and motorized exhaust air flap
- Furnace in DB design featuring fresh air preheating, exhaust gas ventilation and an extensive safety package for debinding and sintering in one process, i. e. without transferring the material from the debinding furnace to the sintering furnace
- Stainless steel exhaust gas top hats
- Special heating elements for zirconia sintering provide for longer service life with respect to chemical interaction between charge and heating elements
- Protective gas connection to purge with non-flammable protective or reaction gases
- Manual or automatic gas supply system
- Inner process box to improve the gas tightness and to protect the furnace chamber against contamination
- Lift door
- Motorized exhaust air flap, switchable via the program
- Thermal or catalytic exhaust cleaning systems see page 66
- Process control and documentation via VCD software package or Nabertherm Control Center (NCC) for monitoring, documentation and control see page 72



Model	Tmax °C	Inner dimensions in mm			Volume in l	Outer dimensions ² in mm			Connected load kW	Electrical connection*	Weight in kg
		w	d	h		W	D	H			
HT 04/16	1600	150	150	150	4	730	490	1400	5.2	3-phase ¹	150
HT 08/16	1600	150	300	150	8	730	640	1400	8.0	3-phase ¹	200
HT 16/16	1600	200	300	260	16	810	700	1500	12.0	3-phase ¹	270
HT 29/16	1600	275	300	350	29	975	740	1620	8.0	3-phase ¹	350
HT 40/16	1600	300	350	350	40	1000	800	1620	12.0	3-phase	380
HT 64/16	1600	400	400	400	64	1130	900	1670	18.0	3-phase	550
HT 128/16	1600	400	800	400	128	1130	1290	1670	26.0	3-phase	750
HT 160/16	1600	500	550	550	160	1250	1050	1900	21.0	3-phase	800
HT 276/16	1600	500	1000	550	276	1300	1600	1900	36.0	3-phase	1100
HT 450/16	1600	500	1150	780	450	1350	1740	2120	64.0	3-phase	1500
HT 04/17	1750	150	150	150	4	730	490	1400	5.2	3-phase ¹	150
HT 08/17	1750	150	300	150	8	730	640	1400	8.0	3-phase ¹	200
HT 16/17	1750	200	300	260	16	810	700	1500	12.0	3-phase ¹	270
HT 29/17	1750	275	300	350	29	975	740	1620	8.0	3-phase ¹	350
HT 40/17	1750	300	350	350	40	1000	800	1620	12.0	3-phase	380
HT 64/17	1750	400	400	400	64	1130	900	1670	18.0	3-phase	550
HT 128/17	1750	400	800	400	128	1130	1290	1670	26.0	3-phase	750
HT 160/17	1750	500	550	550	160	1250	1050	1900	21.0	3-phase	800
HT 276/17	1750	500	1000	550	276	1300	1600	1900	36.0	3-phase	1100
HT 450/17	1750	500	1150	780	450	1350	1740	2120	64.0	3-phase	1500
HT 04/18	1800	150	150	150	4	730	490	1400	5.2	3-phase ¹	150
HT 08/18	1800	150	300	150	8	730	640	1400	8.0	3-phase ¹	200
HT 16/18	1800	200	300	260	16	810	700	1500	12.0	3-phase ¹	270
HT 29/18	1800	275	300	350	29	975	740	1620	8.0	3-phase ¹	350
HT 40/18	1800	300	350	350	40	1000	800	1620	12.0	3-phase	380
HT 64/18	1800	400	400	400	64	1130	900	1670	18.0	3-phase	550
HT 128/18	1800	400	800	400	128	1130	1290	1670	26.0	3-phase	750
HT 160/18	1800	500	550	550	160	1250	1050	1900	21.0	3-phase	800
HT 276/18	1800	500	1000	550	276	1300	1600	1900	42.0	3-phase	1100
HT 450/18	1800	500	1150	780	450	1350	1740	2120	64.0	3-phase	1500

¹Heating only between two phases

*Please see page 73 for more information about supply voltage

²External dimensions vary when furnace is equipped with additional equipment. Dimensions on request

High-temperature furnace HT 64/16S with pneumatically driven and parallel lift door



Two-door design for high-temperature furnaces > HT 276/..



Ovens, also with Safety Technology According to EN 1539



Oven TR 450



Oven TR 240



Electrical rotating device as additional equipment



Extricable metal grids to load the oven in different layers

With their maximum working temperature of up to 300 °C and air circulation, the ovens achieve a perfect temperature uniformity which is much better than in ovens of most competitors. They can be used for various applications such as e.g. drying, sterilizing or warm storing. Ample warehousing of standard models provides for short delivery times.

- Tmax 300 °C
- Working temperature range: + 5 °C above room temperature up to 300 °C
- Ovens TR 30 - TR 240 designed as tabletop models
- Ovens TR 450 and TR 1050 designed as floor standing models
- Horizontal, air circulation results in temperature uniformity better than +/- 5 °C (oven TR 30 up to +/- 4 °C) with closed exhaust flap in the empty workspace according to DIN 17052-1 see page 68
- Stainless steel chamber, alloy 304 (AISI)/(DIN material no. 1.4301), rust-resistant and easy to clean
- Exclusive use of insulation materials without categorization according to EC Regulation No 1272/2008 (CLP). This explicitly means that alumino silicate wool, also known as "refractory ceramic fiber" (RCF), which is classified and possibly carcinogenic, is not used.
- Large handle to open and close the door
- Charging in multiple layers possible using removeable grids (number of removeable grids included, see table to the right)
- Large, wide-opening swing door, hinged on the right with quick release for models TR 30 - TR 450
- Double swing door with quick release for TR 1050
- TR 1050 equipped transport rollers
- Infinitely adjustable exhaust at the rear wall with operation from the front
- PID microprocessor control with self-diagnosis system
- Solid state relays provide for lownoise operation
- Defined application within the constraints of the operating instructions
- NTLog Basic for Nabertherm controller: recording of process data with USB-flash drive
- Controls description see page 72



Oven TR 420



Oven TR 1050 with double door

Additional equipment

- Over-temperature limiter with adjustable cutout temperature as temperature limiter to protect the oven and load
- Infinitely adjustable fan speed of the air circulation fan
- Window for charge observing
- Further removeable grids with rails
- Side inlet
- Stainless steel collecting pan to protect the furnace chamber
- Door hinges on the left side
- Reinforced bottom plate
- Safety technology according to EN 1539 for charges containing liquid solvents (TR .. LS) up to model TR 240 LS, achievable temperature uniformity +/- 8 °C see page 68
- Transport castors for model TR 450
- Various modifications available for individual needs
- Upgrading available to meet the quality requirements of AMS2750F or FDA
- Process control and documentation via VCD software package for monitoring, documentation and control see page 72



Oven TR 120 LS with safety technology according to EN 1539 for charges containing liquid solvents

Model	Tmax in °C	Inner dimensions in mm			Volume in l	Outer dimensions ¹ in mm			Connected load in kW	Electrical connection*	Weight in kg	Minutes to Tmax ²	Grids included	Grids max.	Max. total load ³
		w	d	h		W	D	H							
TR 30	300	360	300	300	30	610	570	665	2.1	1-phase	45	25	1	4	80
TR 60	300	450	390	350	60	700	610	710	3.1	1-phase	90	25	1	4	120
TR 60 LS	260	450	360	350	60	700	820	710	5.3	3-phase	100	25	1	4	120
TR 120	300	650	390	500	120	900	610	860	3.1	1-phase	120	45	2	7	150
TR 120 LS	260	650	360	500	120	900	820	870	6.3	3-phase	120	45	2	7	150
TR 240	300	750	550	600	240	1000	780	970	3.1	1-phase	165	60	2	8	150
TR 240 LS	260	750	530	600	240	1000	990	970	6.3	3-phase	180	60	2	8	150
TR 420	300	1300	550	600	420	1550	815	970	6.3	3-phase	250	60	2	8	200
TR 450	300	750	550	1100	450	1000	780	1470	6.3	3-phase	235	60	3	15	180
TR 450 LS	260	750	530	1100	450	1000	990	1470	12.6	3-phase	250	60	3	15	180
TR 800	300	1200	670	1000	800	1470	970	1520	6.3	3-phase	360	80	3	10	250
TR 1050	300	1200	670	1400	1050	1470	970	1920	9.3	3-phase	450	80	4	14	250

¹External dimensions vary when furnace is equipped with additional equipment. Dimensions on request

²In the empty and closed oven, connected to 230 V 1/N/PE resp. 400 V 3/N/PE

³Max load per layer 30 kg

*Please see page 75 for more information about supply voltage

Chamber Ovens

Electrically Heated or Gas-Fired



Chamber oven KTR 1500



Chamber oven KTR 4500



Chamber oven KTR 6125

The chamber ovens of the KTR range can be used for complex drying processes and heat treatment of charges to an application temperature of 260 °C. The high-performance air circulation enables optimum temperature uniformity throughout the work space. A wide range of accessories allow the chamber ovens to be modified to meet specific process requirements. The design for the heat treatment of flammable materials in conformance with EN 1539 (NFPA 86) is available for all sizes.

- Tmax 260 °C
- Electrically heated (via a heating register with integrated chrome steel heating elements) or gas-fired (direct or indirect gas-fired including injection of the hot air into the intake duct)



Chamber oven KTR 1500 with charging cart

- Temperature uniformity up to ± 3 °C according to DIN 17052-1 (for design without track cutouts) see page 68
- High-quality mineral wool insulation provides for outer temperatures of < 25 °C above room temperature
- Exclusive use of insulation materials without categorization according to EC Regulation No 1272/2008 (CLP). This explicitly means that aluminosilicate wool, also known as "refractory ceramic fiber" (RCF), which is classified and possibly carcinogenic, is not used.
- High air exchange for fast drying processes
- Double-wing door for furnaces KTR 3100 and larger



Chamber oven KTR 22500/S with chamber lightning and drive-in tracks with insulated plugs which provide for an optimal temperature uniformity

- Over-temperature limiter with adjustable cutout temperature as temperature limiter to protect the oven and load
- Incl. floor insulation
- Defined application within the constraints of the operating instructions
- NTLog Basic for Nabertherm controller: recording of process data with USB-flash drive
- Controls description see page 72

Additional equipment

- Track cutouts for level drive-in of charging cart
- Base frame to charge the oven via a charging forklift
- Additional door in the back for charging from both sides or to use the oven as lock between two rooms
- Fan system for faster cooling with manual or motorized control of the exhaust flaps
- Programmed opening and closing of exhaust air flaps
- Air circulation with speed control, recommendable for processes with light or sensitive charge
- Observation window and furnace chamber lighting
- Safety technology according to EN 1539 (NFPA 86) (models KTR .. LS) for charges containing solvents
- Charging cart with or without rack system
- Design for clean room heat treatment processes
- Rotating systems for tempering processes
- Process control and documentation via VCD software package or Nabertherm Control Center (NCC) for monitoring, documentation and control see page 72



KTR 3100/S for curing of composites in vacuum bags incl. pump and necessary connections in the oven chamber



Direct gas-firing at a chamber dryer

Chamber Ovens

Electrically Heated or Gas-Fired



Charging cart with pull-out trays



Chamber oven KTR 6250 with double doors in the front and in the back as well as guide-in tracks for use as sluice oven



Drive-in tracks with sealing shoes

Accessories

- Adjustable plate shutters to adapt the air guide to the charge and improve temperature uniformity
- Guide-in tracks and shelves
- Shelves with 2/3 extraction with evenly distributed load on the whole shelf surface
- Platform cart in combination with drive-in tracks
- Charging cart with rack system in combination with drive-in tracks
- Sealing shoes for ovens with drive-in tracks to improve temperature uniformity in the work space

All KTR-models are also available with Tmax 300 °C.



Pull-out shelves, running on rolls

Model	Tmax °C	Inner dimensions in mm			Volume in l	Outer dimensions in mm ²			Heating power in kW ¹ KTR/KTR ..LS	Electrical connection*
		w	d	h		W	D	H		
KTR 1000 (LS)	260	1000	1000	1000	1000	1900	1430	1815	18/on request	3-phase
KTR 1500 (LS)	260	1000	1000	1500	1500	1900	1430	2315	18/36	3-phase
KTR 3100 (LS)	260	1250	1250	2000	3100	2150	1680	2905	27/45	3-phase
KTR 4500 (LS)	260	1500	1500	2000	4500	2400	1930	2905	45/54	3-phase
KTR 6125 (LS)	260	1750	1750	2000	6125	2650	2200	3000	45/63	3-phase
KTR 6250 (LS)	260	1250	2500	2000	6250	2150	3360	3000	54/on request	3-phase
KTR 8000 (LS)	260	2000	2000	2000	8000	2900	2450	3000	54/81	3-phase
KTR 9000 (LS)	260	1500	3000	2000	9000	2400	3870	3000	72/on request	3-phase
KTR 12300 (LS)	260	1750	3500	2000	12300	2650	4400	3000	90/on request	3-phase
KTR 16000 (LS)	260	2000	4000	2000	16000	2900	4900	3000	108/on request	3-phase
KTR 21300 (LS)	260	2650	3550	2300	21300	3750	4300	3500	108/on request	3-phase
KTR22500 (LS)	260	2000	4500	2500	22500	2900	5400	3500	108/on request	3-phase

¹Depending on furnace design connected load might be higher

²Outer dimensions from chamber ovens KTR .. LS are different

*Please see page 73 for more information about supply voltage

Max. amount of silicone per charge at a fresh air amount of 120 l/min/kg_{silicone}

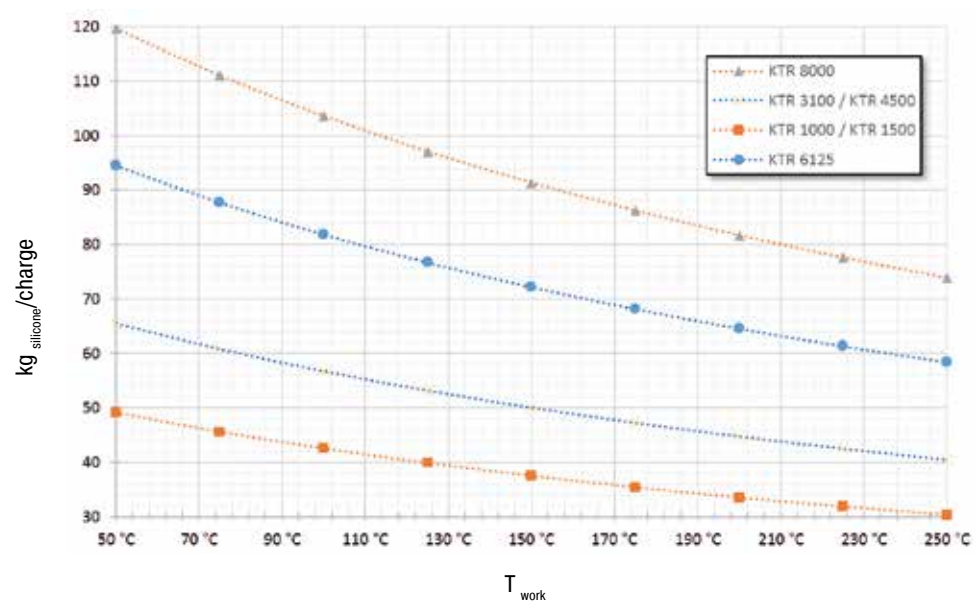

Adjustable plate shutters to adapt the air guide to the charge

To ensure safe operation of the oven when tempering silicone, the fresh air supply of the oven must be monitored. A fresh air volume flow of 100 - 120 l/min/kg silicone (6-7,2 m³/h/kg silicone) has to be considered. The graph shows the maximum amount of silicone depending on the operating temperature for various KTR models at a fresh air supply of 120 l/min/kg silicone. The oven will be carried out in accordance with the requirements of the standard EN 1539 (NFPA 86).



Motorized rotary rack with baskets for moving the charge during heat treatment



KTR 3100 DT with rotating system for tempering of silicone parts. Four baskets will be charged in the frame and can be taken out separately



Drive-in ramp

Catalytic and Thermal Afterburning Systems, Exhaust Gas Washer



Catalytic afterburning system independent from furnace model for refitting on existing plants

For exhaust gas cleaning, in particular in debinding, Nabertherm offers exhaust gas cleaning systems tailored to the process. The afterburning system is permanently connected to the exhaust gas fitting of the furnace and accordingly integral part of the control system and the safety matrix of the furnace. For existing furnaces, independent exhaust gas cleaning systems are also available that can be separately controlled and operated.

Catalytic afterburning systems (KNV)

Catalytic exhaust cleaning is recommended due to energetic reasons when only pure hydrocarbon compounds must be cleaned during the debinding process in air. They are recommended for small to medium exhaust gas amounts.

- Perfectly suited for debinding processes in air with only organic exhaust gases
- Decomposition of gases in carbon dioxide and water
- Integrated in a compact stainless steel housing
- Electric heating provides for preheating of the exhaust gas to the optimal reaction temperature for catalytic treatment
- Cleaning in different layers of catalytic honeycombs within the system
- Thermocouples for measuring the temperatures of raw gas, reaction honeycombs and discharge
- Over-temperature limiter with adjustable cutout temperature protects the catalyst
- Tight connection between the exhaust gas outlet of the debinding furnace and the exhaust gas fan with corresponding integration into the overall system with respect to control and safety technology
- Catalyst dimensioned in relation to the exhaust gas flow
- Measuring port for clean gas measurements (FID)



Air circulation chamber furnace NA 500/65 DB200 with catalytic afterburner system.

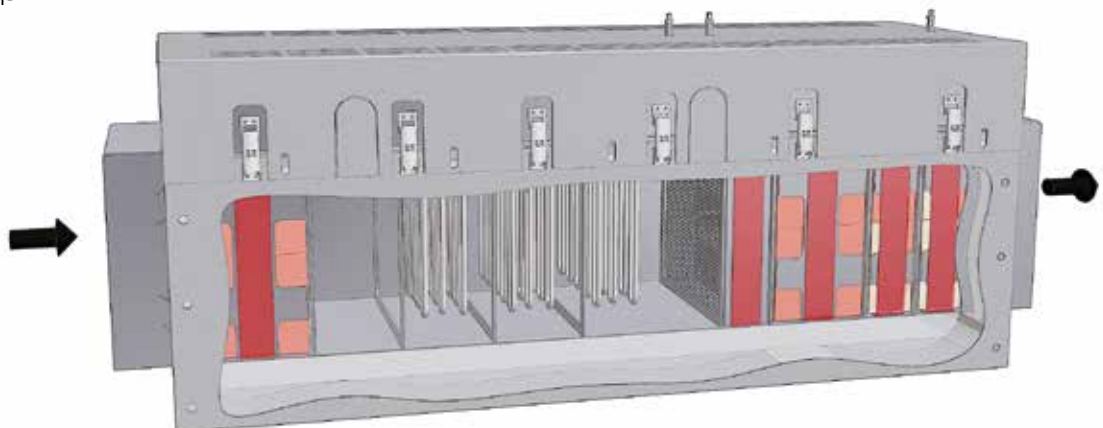

Scheme of a catalytic afterburning system

Thermal afterburning systems (TNV)

Thermal afterburning systems are used if large volumes of exhaust gas from the debinding process in air must be cleaned and/or if there is a risk that the exhaust gases might damage the catalyst. Thermal afterburning is also used for debinding applications under non-flammable or flammable protective or reaction gases.

- Optimally suited for debinding processes in air with large exhaust gas flow, erratic large exhaust gas volumes, large volume flow or for debinding processes under non-flammable or flammable protective or reaction gases
- Gas-fired to burn the exhaust gases
- Burn-off at temperatures up to 850 °C provides for thermal decomposition of the exhaust gases
- Heating with compact gas burner with automatic firing device



Air circulation chamber furnace NA 500/06 DB200-2 with thermal afterburning system

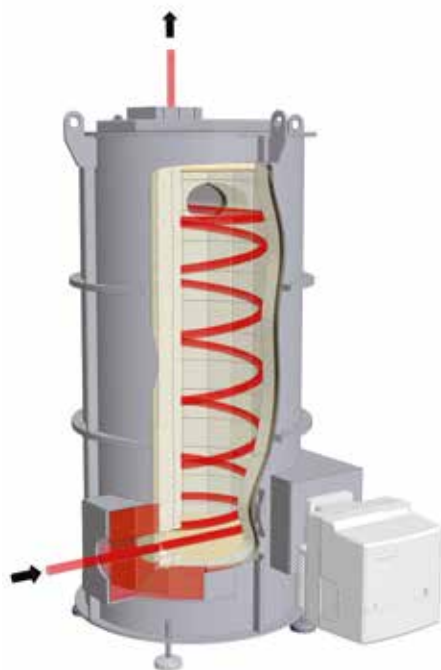

- Thermocouples in the combustion chamber and in the raw gas inlet
- Over-temperature limiter for protecting the thermal afterburning
- Design depending on the exhaust gas flow
- Measuring port for clean gas measurements (FID)

Scheme of a thermal afterburner system

Exhaust Gas Washer

An exhaust gas washer will be often used if the generated gases cannot be effectively treated with a thermal afterburner system or with a torch. To clean, detox or decontaminate the exhaust gas stream a liquid is used to wash or neutralize unwanted pollutants. The exhaust gas washer can be adapted to the process by designing its liquid distribution and contact area and by selecting the most suitable washing liquid. Liquids may simply be water or special reagents or even suspensions to successfully remove unwanted gases, liquids or particles from the exhaust gas.



Exhaust gas washer to clean generated process gases by washing out

Temperature Uniformity and System Accuracy

Temperature uniformity is defined as the maximum temperature deviation in the work space of the furnace. There is a general difference between the furnace chamber and the work space. The furnace chamber is the total volume available in the furnace. The work space is smaller than the furnace chamber and describes the volume which can be used for charging.



Holding frame for measurement of temperature uniformity

Specification of Temperature Uniformity in +/- K in the Standard Furnace

In the standard design the temperature uniformity is specified in +/- K at a defined set-temperature with the work space of the empty furnace during the dwell time. In order to make a temperature uniformity survey the furnace should be calibrated accordingly. As standard our furnaces are not calibrated upon delivery.

Calibration of the Temperature Uniformity in +/- K

If an absolute temperature uniformity at a reference temperature or at a defined reference temperature range is required, the furnace must be calibrated appropriately. If, for example, a temperature uniformity of +/- 5 K at a set temperature of 750 °C is required, it means that measured temperatures may range from a minimum of 745 °C to a maximum of 755 °C in the empty work space.

System Accuracy

Tolerances may occur not only in the work space, they also exist with respect to the thermocouple and in the controls. If an absolute temperature uniformity in +/- K at a defined set temperature or within a defined reference working temperature range is required, the following measures have to be taken:

- Measurement of total temperature deviation of the measurement line from the controls to the thermocouple
- Measurement of temperature uniformity within the work space at the reference temperature or within the reference temperature range
- If necessary, an offset is set at the controls to adjust the displayed temperature at the controller to the real temperature in the furnace
- Documentation of the measurement results in a protocol

Temperature Uniformity in the Work Space incl. Protocol

In standard furnaces, temperature uniformity is guaranteed as +/- K without measurement of temperature uniformity. However, as an additional feature, a temperature uniformity measurement at a target temperature in the work space compliant with DIN 17052-1 can be ordered. Depending on the furnace model, a holding frame which is equivalent in size to the work space is inserted into the furnace. This frame holds thermocouples at up to 11 defined measurement positions. The measurement of the temperature uniformity is performed at a target temperature specified by the customer after a static condition has been reached. If necessary, different target temperatures or a defined target working temperature range can also be calibrated.



Pluggable frame for measurement for forced convection chamber furnace N 7920/45 HAS

The system accuracy is defined by adding the tolerances of the controls, the thermocouple and the work space



Precision of the controls, e. g. +/- 1 K

Deviation of thermocouple, e. g. +/- 1.5 K

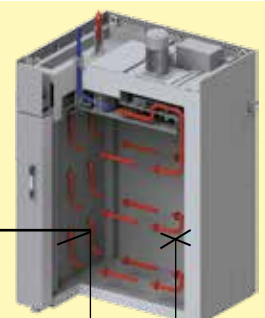

Deviation from measuring point to the average temperature in the work space e. g. +/- 3 K

AMS2750F, NADCAP, CQI-9

Standards such as the AMS2750F (Aerospace Material Specifications) are applicable for the industrial processing of high-quality materials. They define industry-specific requirements for heat treatment. Today, the AMS2750F and derivative standards such as AMS2770 for the heat treatment of aluminum are the guidelines for the aerospace industry. After the introduction of the CQI-9, the automotive industry has also committed to submit heat treatment processes to stricter rules. These standards describe in detail the requirements applicable to thermal processing plants.

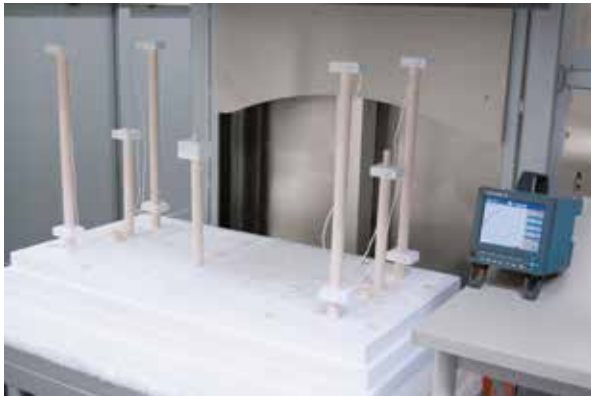

Measurement set-up in a high-temperature furnace

- Temperature uniformity in the work space (TUS)
- Instrumentation (definition of measurement and control systems)
- Calibration of the measurement system (IT) from the controller via the measurement line to the thermocouple
- Inspections of system accuracy (SAT)
- Documentation of the inspection cycles

Norm compliance is necessary to ensure that the required quality standard of the manufactured components can also be reproduced in series. For this reason, extensive and repeated inspections as well as controls of the instrumentation, including the relevant documentation, are required.

Furnace Class and Instrumentation Requirements of the AMS2750F

Depending on the quality requirements of heat treatment job the customer specifies instrumentation type and the temperature uniformity class. The instrumentation type describes the necessary combination of the applied control, recording media as well as thermocouples. The temperature uniformity of the furnace and the class of the selected instrumentation are defined based on the required furnace class. The higher the requirements are set for the furnace class the more precise the instrumentation must be.

Regular Inspections

The furnace or the heat treatment plant must be designed so that the requirements of the AMS2750F can be met and be reproduced. The standard also requires the inspection intervals for the instrumentation (SAT = System Accuracy Test) and the temperature uniformity of the furnace (TUS = Temperature Uniformity Survey). The SAT/TUS tests must be performed by the customer with measuring devices and sensors which operate independently of the furnace instrumentation.

Instrumentation	Type						Furnace class	Temperature uniformity	
	A	B	C	D+	D	E		°C	°F
Each control zone has a thermocouple connected to the controller	x	x	x	x	x	x	1	+/- 3	+/- 5
Recording of the temperature measured by the control thermocouple	x	x	x	x	x		2	+/- 6	+/- 10
Sensors for recording the coldest and hottest spots	x		x				3	+/- 8	+/- 15
Each control zone has a charge thermocouple with recording system	x	x					4	+/- 10	+/- 20
One additional recording sensor, distance ≥ 76 mm to control sensor, of a different sensor type				x			5	+/- 14	+/- 25
Each control zone has an over-temperature protection unit	x	x	x	x	x		6	+/- 28	+/- 50



Measurement set-up in an annealing furnace



Measuring protocol



Measurement range calibration

AMS2750F, NADCAP, CQI-9

The suitable furnace model for the corresponding heat treatment can be designed based on the process, the charge, the required furnace class and the type of instrumentation. Depending on the required specs, alternative solutions can be offered.



N 12012/26 HAS1 according to AMS2750F

- Furnace designs, which meet standards, following customer specifications regarding furnace class and instrumentation, incl. gauge connections for repeated customer inspections at regular intervals. No consideration of requirements with respect to documentation
- Data recording devices (e.g., temperature recorder) for TUS and/or SAT measurements see page 12
- Data recording, visualization, time management via the Nabertherm Control Center (NCC), based on Siemens WinCC software see page 13
- Commissioning at site, incl. the first TUS and SAT inspection
- Connection of existing furnace plant to meet norm requirements
- Documentation of the complete process chain in line with the corresponding norm

Implementation of AMS2750F

Basically, two different systems are available for control and documentation, a proven Nabertherm system solution or instrumentation using Eurotherm controllers/temperature recorders. The Nabertherm AMS package is a convenient solution that includes the Nabertherm Control Center for control, visualization, and documentation of the processes and test requirements based on PLC control.

Instrumentation with Nabertherm Control Center (NCC)

The attractive feature of the instrumentation with Nabertherm Control Center in combination with PLC controls of the furnace is the convenient data input and visualization. The software programming is structured in a way that both the user and the auditor can navigate it without difficulty.

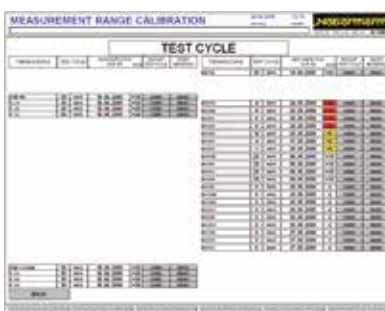
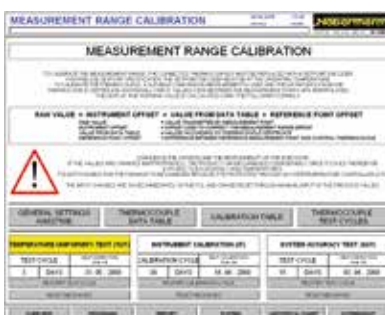

In daily use, the following product characteristics stand out:

- Very easy to navigate and straight-forward presentation of all the data in plain text on the PC
- Automatic saving of the charge documentation at the end of the program
- Administration of the calibration cycles in the NCC
- Results of the measurement distance calibration are entered in the NCC
- Schedule management of the required testing cycles including a reminder function. The testing cycles for TUS (Temperature Uniformity Survey) and SAT (System Accuracy Test) are entered in days and monitored by the system and the operator or tester is informed in time about up-coming tests. The measurements have to be done with separate calibrated measuring equipment.
- Option of transferring the measurement data to a customer's server

The Nabertherm Control Center can be extended to enable a complete documentation of the heat treatment process apart from just the furnace data. For example, when heat-treating aluminum, in addition to the furnace, the temperatures in the quenching basin or a separate cooling medium can also be documented.

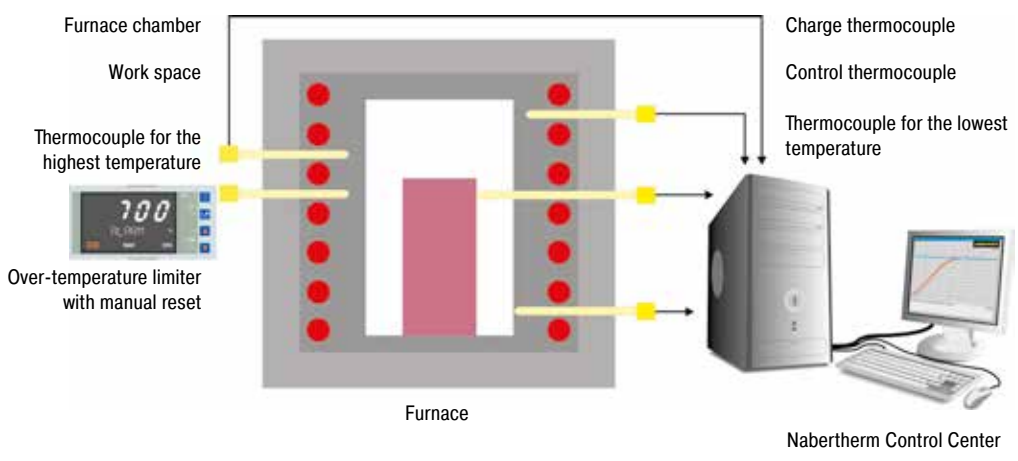

Example of a design with Type A Nabertherm Control Center

Alternative Instrumentation with Temperature Controllers and Recorders from Eurotherm

As an alternative to instrumentation with the Nabertherm Control Center (NCC) and PLC controls, instrumentation with controllers and temperature recorders is also available. The temperature recorder has a log function that must be configured manually. The data can be saved to a USB stick and be evaluated, formatted, and printed on a separate PC. Besides the temperature recorder, which is integrated into the standard instrumentation, a separate recorder for the TUS measurements is needed (see page 12).

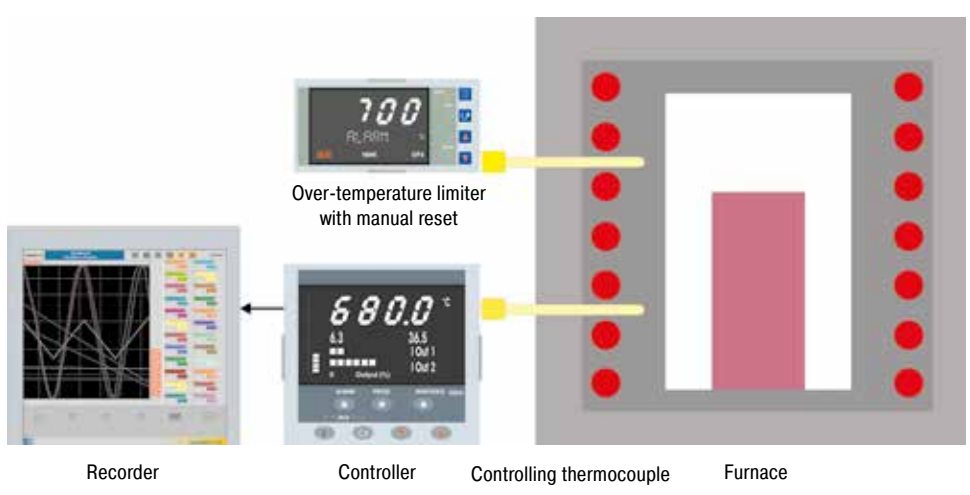

Example of a design containing Type D Eurotherm instrumentation

Furnace Chamber Control

Only the furnace chamber temperature is measured and controlled. Regulation is carried out slowly to avoid out-of-range values. As the charge temperature is not measured and controlled, it may vary a few degrees from the chamber temperature.

Charge Control

If the charge control is switched on, both the charge temperature and furnace chamber temperature are measured. By setting different parameters the heat-up and cooling processes can be individually adapted. This results in a more precise temperature control at the charge.

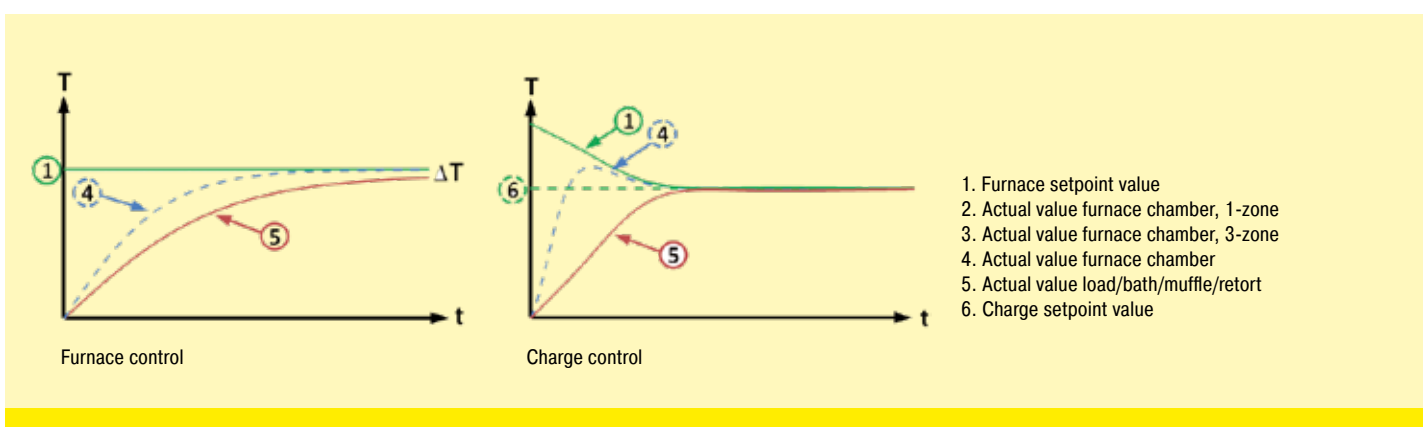

Nabertherm Controller Series 500

**I AM THE
CONTROLLER**

I'm the big brother of analog buttons and turning switches. I am the new generation of control and intuitive operation. My skills are highly complex, my operation is simple. I can be touched and speak 24 languages. I'll show you exactly which program is currently running and when it ends.



The controller series 500 impresses with its unique scope of performance and intuitive operation. In combination with the free "MyNabertherm" smartphone app, the operation and monitoring of the furnace is even easier and more powerful than ever before. The operation and programming takes place via a high-contrast, large touch panel, which shows exactly the information that is relevant at the moment.



Standard Equipment

- Transparent, graphic display of the temperature curves
- Clear presentation of the process data
- 24 operating languages selectable
- Consistent, attractive design
- Easily understandable symbols for many functions
- Precise and accurate temperature control
- User levels
- Program status display with estimated end time and date
- Documentation of the process curves on USB storage medium in .csv file format
- Service information can be read out via USB stick
- Clear presentation
- Plain text display
- Configurable for all furnace families
- Can be parameterized for the different processes



Highlights

In addition to the well-known and matured controller functions, the new generation offers you some individual highlights. Here is an overview of the most important ones for you:

Modern Design



Colored display of temperature curves and process data

Easy Programming



Simple and intuitive program entry via touch panel

Integrated Help Function



Information on various commands in plain text

Program Management



Temperature programs can be saved as favorites and in categories

Segment Player



Detailed overview of process information including setpoint, actual value and switched functions

Wi-Fi-Capable



Connection with the MyNabertherm app



Intuitive touch screen



Easy program entry and control



Precise temperature control



User levels



Process documentation on USB

Further information on Nabertherm controllers, process documentation and tutorials on operation can be found on our website: <https://nabertherm.com/en/series-500>



MyNabertherm App for Mobile Monitoring of Process Progress

MyNabertherm app – the powerful and free digital accessory for Nabertherm 500 Series Controllers. Use the app for convenient online progress monitoring of your Nabertherm furnaces – from your office, while on the way or from wherever you wish. The app always keeps you in the picture. Just like the controller itself, the app is also available in 24 languages.



Convenient monitoring of one or multiple Nabertherm furnaces simultaneously



Display of program progress for each furnace



Easy to contact

App-Functions

- Convenient monitoring of one or multiple Nabertherm furnaces simultaneously
- Clear presentation as a dashboard
- Individual overview of a furnace
- Display of active/inactive furnaces
- Operating status
- Current process data

Display of Program Progress for Each Furnace

- Graphical representation of the program progress
- Display of furnace name, program name, segment information
- Display of start time, program run time, remaining run time
- Display of additional functions such as fresh-air fan, exhaust air flap, gassing, etc.
- Operating modes as symbol

Push Notifications in Case of Malfunctions and at Program End

- Push notification on the lock screen
- Display of malfunctions with an associated description in the individual overview and in a message list

Contact with Service Possible

- Stored furnace data facilitate rapid support for you

Requirements

- Connection of the furnace to the Internet via the customer's Wi-Fi
- For mobile devices with Android (from version 9) or IOS (from version 13)



Monitoring of Nabertherm furnaces with 500 series touch panel controller for Arts & Crafts, laboratory, dental, thermal process technology, advanced materials and foundry applications.

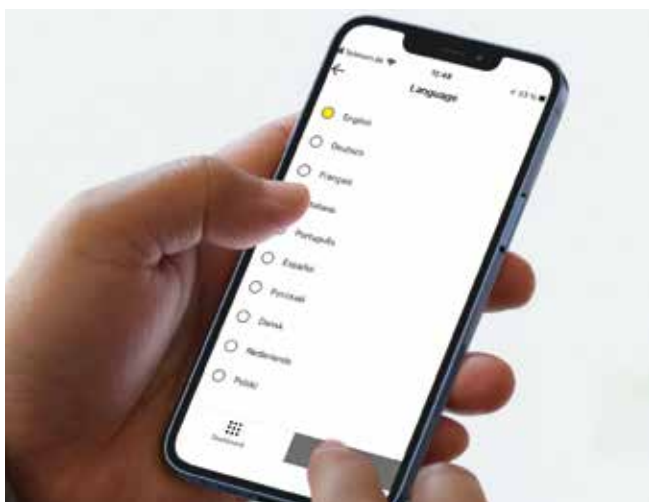

Available in 24 languages



Push notifications in case of malfunctions



Clear contextual menu

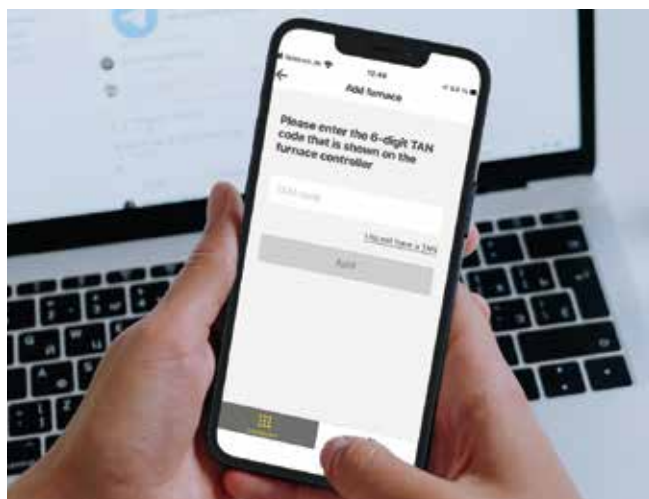

Any addition of Nabertherm furnaces

Everything on display in the new Nabertherm app for the new controller series 500. Get the most out of your furnace with our app for iOS and Android. Don't hesitate to download it now.



Functions of the Standard Controllers

	R7	3216	3208	B500/ B510	C540/ C550	P570/ P580	3508	3504	H500	H1700	H3700	NCC
Number of programs	1	1		5	10	50	1/10/ 25/50 ³	1/10/ 25/50 ³	20	20	20	100
Segments	1	8		4	20	40	500 ³	500 ³	20	20	20	20
Extra functions (e. g. fan or autom. flaps) maximum				2	2	2-6	0-4 ³	2-8 ³	3 ³	6/2 ³	8/2 ³	16/4 ³
Maximum number of control zones	1	1	1	1	1	3	2 ^{1,2}	2 ^{1,2}	1-3 ³	8	8	8
Drive of manual zone regulation				●	●	●						
Charge control/bath control						●	○	○	○	○	○	○
Auto tune		●	●	●	●	●	●	●				
Real-time clock				●	●	●			●	●	●	●
Graphic color display				●	●	●			4" 7"	7"	12"	22"
Graphic display of temperature curves (program sequence)												
Status messages in clear text			●	●	●	●	●	●	●	●	●	●
Data entry via touchpanel				●	●	●			●	●	●	●
Entering program names (i.e. "Sintering")				●	●	●			●	●	●	●
Keypad lock				●	●	●	○	○				
User levels				●	●	●	●	●	○	○	○	●
Skip-button for segment jump				●	●	●			●	●	●	●
Program entry in steps of 1 °C or 1 min.	●	●	●	●	●	●	●	●	●	●	●	●
Start time configurable (e. g. to use night power rates)				●	●	●	●	●	●	●	●	●
Switch-over °C/°F	○	○	○	●	●	●	○	○	●	● ³	● ³	● ³
kWh meter				●	●	●						
Operating hour counter				●	●	●			●	●	●	●
Set point output			○	●	●	●	○	○		○	○	○
NTLog Comfort for HiProSystems: recording of process data on an external storage medium									○	○	○	
NTLog Basic for Nabertherm controller: recording of process data with USB-flash drive				●	●	●						
Interface for VCD software				○	○	○	○	○				
Malfunction memory				●	●	●			●	●	●	●
Number of selectable languages				24	24	24						
Wi-Fi-capable („MyNabertherm" app)				●	●	●						

¹ Not for melt bath control

² Control of additional separate slave regulators possible

³ Depending on the design

● Standard

○ Option

Assignment of Standard Controllers to Furnace Families

	NR(A) 17/06 - NR(A) 1000/11	NR, NRA .. H ₂	NR, NRA .. IDB	NR, NRA 40/02 CDB	NR, NRA 150/02 CDB	SR(A) 17/06 - SR(A) 1500/11	VHT	VHT .. H ₂	LBVHT	LH 15/12 - LF 120/14	NW	N 7/H - N 87/H	N 81(/..) - N 641(/..)	NA 15/65	NA 30/45 - N 500/85 HA	NA-I, NA-SI	SAL 30/45 - SAL 500/85	L .. /11 BO	LHT	HT	TR	TR ..LS	KTR
Catalog page	14	16	16	19	19	21	22	26	27	30	34	36	36	42	42	47	48	56	57	58	60	60	62
Controller																							
C6/3208																							
3504	○					○																	
R 7																							
B500										●	●	●	●	●	●	●	●				●		●
B510														●							○		
C540										○	○	○	○	○	○	○	○				○		○
C550																							
P570	●					●	● ³		● ³	○	○	○	○	○	○	○	○	●		● ³	○	●	○
P580														○				○			○		
H500/PLC																							
H700/PLC																					● ³		
H1700/PLC			●	●		○	○														○		○
H3700/PLC	○	●			●	○	○	●	○												○		○
NCC	○	○	○	○	○	○	○	○	○	○											○		○

Mains Voltages for Nabertherm Furnaces

1-phase: all furnaces are available for mains voltages from 110 V - 240 V at 50 or 60 Hz.

3-phase: all furnaces are available for mains voltages from 200 V - 240 V or 380 V - 480 V, at 50 or 60 Hz.

The connecting rates in the catalog refer to the standard furnace with 400 V (3/N/PE) respectively 230 V (1/N/PE).

Process Data Storage and Data Input via PC



There are various options for evaluation and data input the processes for optimal process documentation and data storage. The following options are suitable for data storage when using the standard controllers.

Data Storing of Nabertherm Controllers with NTLog Basic

NTLog Basic allows for recording of process data of the connected Nabertherm Controller (B500, B510, C540, C550, P570, P580) on a USB stick. The process documentation with NTLog Basic requires no additional thermocouples or sensors. Only data recorded which are available in the controller. The data stored on the USB stick (up to 130,000 data records, format CSV) can afterwards be evaluated on the PC either via NTGraph or a spreadsheet software used by the customer (e.g. Excel™ for MS Windows™). For protection against accidental data manipulation the generated data records contain checksums.

Visualization with NTGraph for MS Windows™ for Single-Zone Controlled Furnaces

The process data from NTLog can be visualized either using the customer's own spreadsheet program (e.g. Excel™ for MS Windows™) or NTGraph for MS Windows™ (Freeware). With NTGraph Nabertherm provides for an additional user-friendly tool free of charge for the visualization of the data generated by NTLog. Prerequisite for its use is the installation of the program Excel™ for MS Windows™ (from version 2003). After data import presentation as diagram, table or report can be chosen. The design (color, scaling, reference labels) can be adapted by using prepared sets. NTGraph is available in eight languages (DE/EN/FR/ES/IT/CN/RU/PT). In addition, selected texts can be generated in other languages.

Software NTEdit for MS Windows™ for Entering Programs on the PC

By using the software NTEdit for MS Windows™ (Freeware) the input of the programs becomes clearer and thus easier. The program can be entered on customers PC and then be imported into the controller (B500, B510, C540, C550, P570, P580) with a USB stick. The display of the set curve is tabular or graphical. The program import in NTEdit is also possible. With NTEdit Nabertherm provides a user-friendly free tool. A prerequisite for the use is the client installation of Excel™ for MS Windows™ (from version 2007). NTEdit is available in eight languages (DE/EN/FR/ES/IT/CN/RU/PT).



NTGraph, a freeware for the easy-to-read analysis of recorded data using Excel™ for MS Windows™



Recording of process data of the connected controller via USB stick



Process input via the NTEdit software (freeware) for MS Windows™

Process Data Storage

VCD-software for visualization, control and documentation

Documentation and reproducibility are more and more important for quality assurance. The powerful VCD software represents an optimal solution for single multi furnace systems as well as charge documentation on the basis of Nabertherm controllers.

The VCD software is used to record process data of the series 500 and series 400 as well as various further Nabertherm controllers. Up to 400 different heat treatment programs can be stored. The controllers are started and stopped via the software at a PC. The process is documented and archived accordingly. The data display can be carried-out in a diagram or as data table. Even a transfer of process data to Excel™ for MS Windows™ (.csv format *) or the generation of reports in PDF format is possible.



Example lay-out with 3 furnaces

Features

- Available for controllers series 500 - B500/B510/C540/C550/P570/P580, series 400 - B400/B410/C440/C450/P470/P480, Eurotherm 3504 and various further Nabertherm controllers
- Suitable for operating systems Microsoft Windows 7/8/10/11
- Simple installation
- Setting, Archiving and print of programs and graphics
- Operation of controllers via PC
- Archiving of process curves from up to 16 furnaces (also multi-zone controlled)
- Redundant saving of archives on a server drive
- Higher security level due to binary data storage
- Free input of charge date with comfortable search function
- Possibility to evaluate data, files exportable to Excel™ for MS Windows™
- Generation of a PDF-report
- 24 languages selectable

Extension Package 1 for display of an additional temperature measuring point, independant of the furnace controls

- Connection of an independent thermocouple, type S, N or K with temperature display on a supplied C6D display, e. g. for documentation of charge temperature
- Conversion and transmission of measured values to the VCD software
- For data evaluation, please see VCD-software features
- Display of measured temperature directly on the extension package

Extension Package 2 for the connection of up to three, six or nine measuring point, independant of the furnace controls

- Connection of three thermocouples, tpye K, S, N or B to the included connecting box
- Possible extension of up to two or three connecting boxes with up to nine measuring points
- Conversion and transmission of measured values to the VCD software
- Data evaluation, see VCD features



VCD Software for Control, Visualisation and Documentation



Graphic display of main overview (version with 4 furnaces)

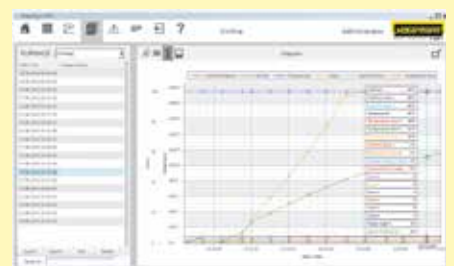

Graphic display of process curve

PLC Controls HiProSystems



This professional process control with PLC controls for single and multi-zone furnaces is based on Siemens hardware and can be adapted and upgraded extensively. HiProSystems control is used when process-dependent functions, such as exhaust air flaps, cooling fans, automatic movements, etc., have to be handled during a cycle, when furnaces with more than one zone have to be controlled, when special documentation of each batch is required and when remote service is required. It is flexible and is easily tailored to your process or documentation needs.

Alternative User Interfaces for HiProSystems

Process Control H500

This basic panel accommodates most basic needs and is very easy to use. Firing cycle data and the extra functions activated are clearly displayed in a table. Messages appear as text. Data can be stored on a USB stick using the „NTLog Comfort“ option.

Process Control H1700

Customized versions can be realized in addition to the scope of services of the H500. Display of basic data as online trend on a color 7" display with graphically structured interface.

Process Control H3700

Display of functions on a large 12" display. Display of basic data as online trend or as a graphical system overview. Scope as H1700.

Remote Maintenance Router – Fast Support in Case of a Malfunction

For fast failure diagnosis in case of a malfunction, remote maintenance systems are used for HiProSystems-plants (depending on the model). The plants are equipped with a router, which will be connected to the internet by the customer. In case of a malfunction, Nabertherm is able to get access to the furnace controls via a secured connection (VPN tunnel) and to perform a malfunction diagnosis. In most cases, the problem can be directly solved by e technician on site according with supervision from Nabertherm.

If no Internet connection can be provided, we offer optionally the remote maintenance via LTE network as additional equipment.



H1700 with colored, tabular depiction



H3700 with colored graphic presentation



Router for remote maintenance

Process Data Storage



The following options are available for industrial process documentation and the recording of data from several furnaces. These can be used to document the process data for the PLC controls.



NTLog Comfort for data recording of a Siemens PLC via USB stick

Data Storing of HiProSystems with NTLog Comfort

The extension module NTLog Comfort offers the same functionality of NTLog Basic module. Process data from a HiProSystems control are read out and stored in real time on a USB stick. The extension module NTLog Comfort can also be connected using an Ethernet connection to a computer in the same local network so that data can be written directly onto this computer.

Temperature Recorder

Besides the documentation via the software which is connected to the controls, Nabertherm offers different temperature recorders which can be used with respect to the application.

	Model 6100e	Model 6100a	Model 6180a
Data input using touch panel	x	x	x
Size of colour display in inch	5.5"	5.5"	12.1"
Number of thermocouple inputs	3	18	48
Data read-out via USB-stick	x	x	x
Input of charge data		x	x
Evaluation software included	x	x	x
Applicable for TUS-measurements acc. to AMS2750F			x

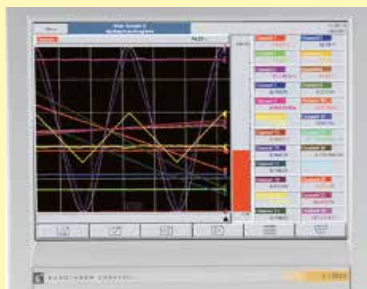

Temperature recorder

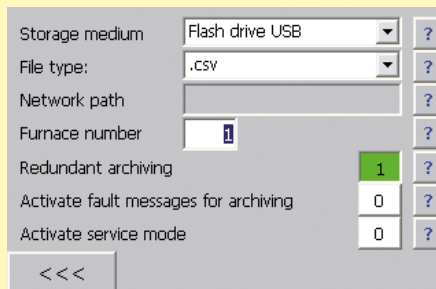

NTLog Comfort - Data recording via USB stick

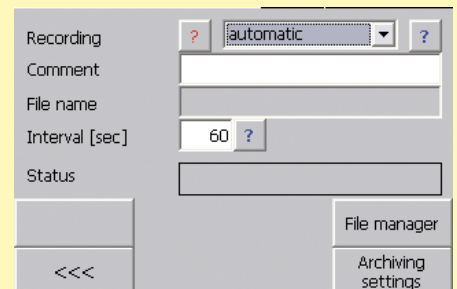

NTLog Comfort - Data recording online on the PC

Nabertherm Control Center NCC

PC-based control, process visualization and process documentation software

The Nabertherm Control Center as PC-supported furnace controls offers an ideal extension for furnaces with PLC based HiProSystem controls. The system has proven itself in many applications with increased demands on documentation and process reliability and also for convenient multi-furnace management. Many customers from the automotive, aviation, medical technology or technical ceramics sectors have been working successfully with this powerful software.



Retort furnace NR 300/08 for treatment in high vacuum

Standard Equipment

- Central furnace management
- Graphical furnace overview of up to 8 furnaces
- Tabular, clear program entry (100 program locations)
- Charge administration (article, quantity, additional information)
- Connection to the company network
- Adjustable access rights
- Online monitoring of the heat treatment
- Tamper-proof documentation
- Malfunction message list, adapted to the furnace model
- Archive function
- Delivery incl. PC and printer
- Measuring range calibration of up to 18 temperatures per measurement point. Multi-stage calibration is possible for applications with normative requirements.



Retort furnace NR 80/11 with IDB safety concept for debinding under non-flammable protective gases

Additional Equipment

- Reading in charge data via barcode
 - Simple data acquisition, ideal for frequently changing charges
 - Defined charge data ensures data quality
- Recipe storage with charge comparison
 - Comparison of charge and recipe to increase process reliability
- Adaptable access rights or access rights via employee cards
- Software extension to fulfill documentation requirements according to norms like AMS2750F (NADCAP), CQI9 or Food and Drug Administration (FDA), Part 11, EGV 1642/03
- Interface for connection to overriding systems
- SQL connection
- Redundant data storage
- Cellular connection or network connection for notification via SMS, e.g. in the event of malfunctions
- Control from different PC workstations
- Configuration as industrial PC or virtual machine
- PC cabinet
- UPS for PC
- Customization according to individual requirements



System overview

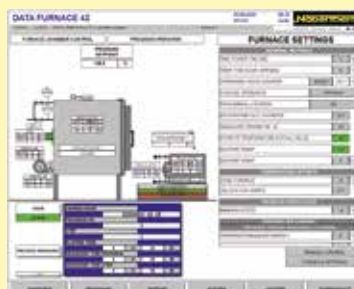

Furnace overview



Measurement range calibration

The whole World of Nabertherm: www.nabertherm.com

Please visit our website

www.nabertherm.com and find out all you want to know about us - and especially about our products.

Besides news and our current calendar of trade fairs, there is also the opportunity to get in touch directly with your local sales office or nearest dealer worldwide.

Professional Solutions for:

- Arts & Crafts
- Glass
- Advanced Materials
- Laboratory
- Dental
- Thermal Process Technology for Metals, Plastics and Surface Finishing
- Foundry



Headquarters:

Nabertherm GmbH

Bahnhofstr. 20
28865 Lilienthal, Germany
contact@nabertherm.de

Sales Organisation

China

Nabertherm Ltd. (Shanghai)
150 Lane, No. 158 Pingbei Road, Minhang District
201109 Shanghai, China
contact@nabertherm-cn.com

France

Nabertherm SARL
20, Rue du Cap Vert
21800 Quetigny, France
contact@nabertherm.fr

Italy

Nabertherm Italia
Via Trento N° 17
50139 Florence, Italy
contact@nabertherm.it

Great Britain

Nabertherm Ltd., United Kingdom
contact@nabertherm.com

Switzerland

Nabertherm Schweiz AG
Altgraben 31 Nord
4624 Härkingen, Switzerland
contact@nabertherm.ch

Spain

Nabertherm España
c/Marti i Julià, 8 Bajos 7ª
08940 Cornellà de Llobregat, Spain
contact@nabertherm.es

USA

Nabertherm Inc.
64 Read's Way
New Castle, DE 19720, USA
contact@nabertherm.com

Benelux

Nabertherm Benelux, The Netherlands
contact@nabertherm.com



All other Countries: Follow

<https://www.nabertherm.com/contacts>

www.nabertherm.com

■ Made
■ in
■ Germany