

Thermal Process Technology II

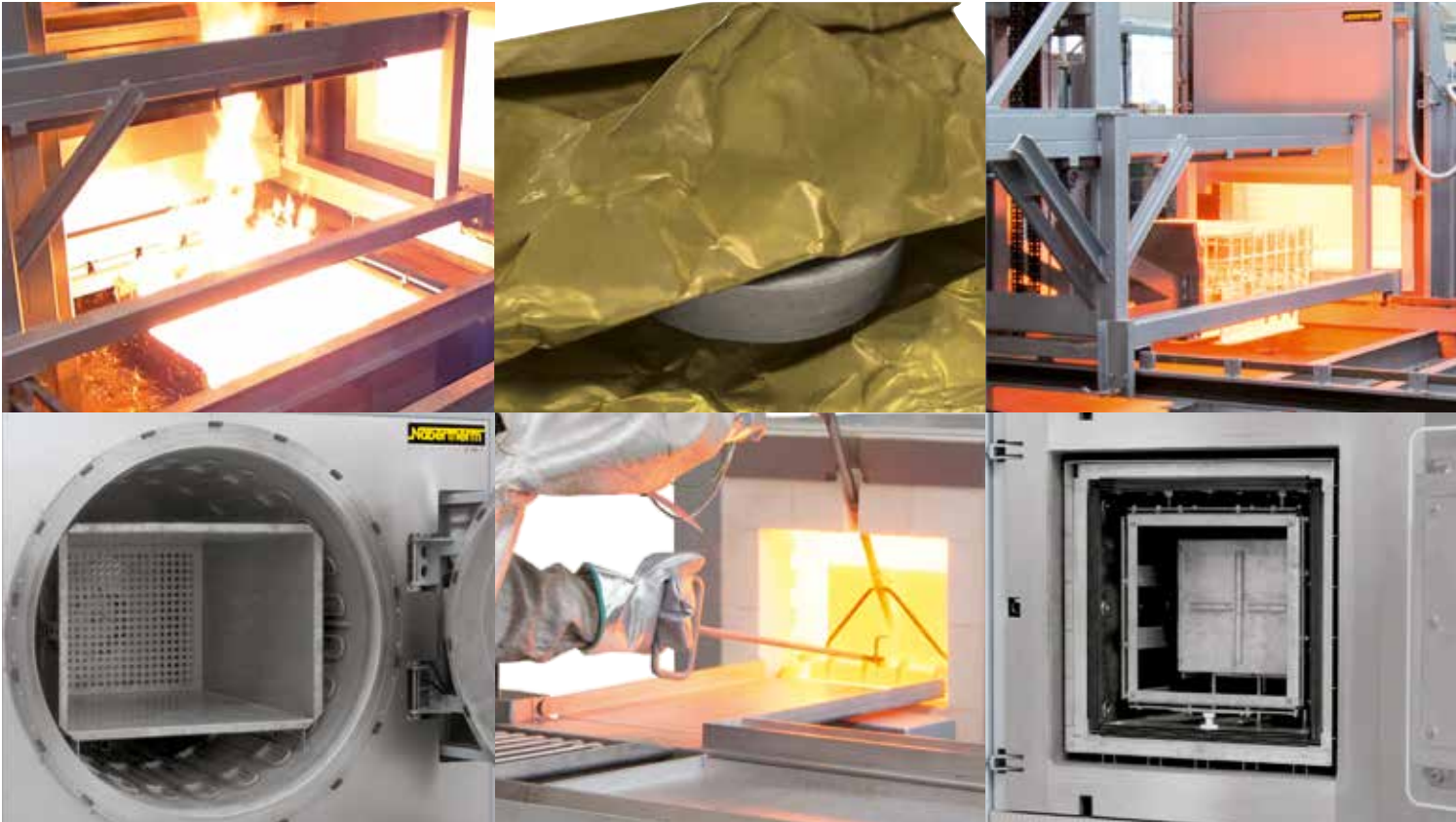

**Furnaces and Heat Treatment Plants
for Processes under
Protective or Reactive Gases or Vacuum**

Retort Furnaces

Continuous and Wire Annealing Furnaces

Tube Furnaces

Salt-Bath Furnaces

Nitriding and Carburizing Furnaces

Furnaces for Additive Manufacturing

Hardening Systems, Quenching Baths

Protective Gas Boxes



Made in Germany

Nabertherm with 500 employees worldwide have been developing and producing industrial furnaces for many different applications for 70 years. As a manufacturer, Nabertherm offers the widest and deepest range of furnaces worldwide. 150,000 satisfied customers in more than 100 countries offer proof of our commitment to excellent design, quality and cost efficiency. Short delivery times are ensured due to our complete inhouse production and our wide variety of standard furnaces.

Setting Standards in Quality and Reliability

Nabertherm does not only offer the widest range of standard furnaces. Professional engineering in combination with in house manufacturing provide for individual project planning and construction of tailor-made thermal process plants with material handling and charging systems. Complete thermal processes are realized by customized system solutions.

Innovative Nabertherm control technology provides for precise control as well as full documentation and remote monitoring of your processes. Our engineers apply state-of-the-art technology to improve the temperature uniformity, energy efficiency, reliability and durability of our systems with the goal of enhancing your competitive edge.

Global Sales and Service Network – Close to you

Nabertherm's strength is one of the biggest R&D department in the furnace industry. In combination with central manufacturing in Germany and decentralized sales and service close to the customer we can provide for a competitive edge to live up to your needs. Long term sales and distribution partners in all important world markets ensure individual on-site customer service and consultation. There are various reference customers in your neighborhood who have similar furnaces or systems.

Large Customer Test Center

Which furnace is the right choice for this specific process? This question cannot always be answered easily. Therefore, we have set up our modern test center which is unique in respect to size and variety. A representative number of furnaces is available for tests for our customers.

Customer Service and Spare Parts

Our professional service engineers are available for you worldwide. Due to our complete inhouse production, we can despatch most spare parts from stock over night or produce with short delivery time.



Experience in Many Fields of Thermal Processing

In addition to furnaces for thermal process technology, Nabertherm offers a wide range of standard furnaces and plants for many other thermal processing applications. The modular design of our products provides for customized solutions to your individual needs without expensive modifications.

Table of Contents

	Page
Furnaces and Accessories for Heat Treatment of Metals	4
Which Furnace for Which Process?	6
Hardening, Carburizing, Nitriding, Brazing, MIM	10
Additive Manufacturing, 3D-Printing	12
Hot-Wall Retort Furnaces up to 1100 °C	16
Cold-Wall Retort Furnaces up to 3000 °C	26
Retort Furnace Cooling Systems	33
Tube Furnaces for Processes under Flammable or Non-Flammable Protective or Reaction Gases or under Vacuum	34
Wire and Strand Annealing Furnaces	36
Continuous Plants for Protective or Reaction Gas Atmospheres	37
Salt-Bath Furnaces for Heat Treatment of Steel or Light Metals	38
Martempering Furnaces using Neutral Salts	41
Chamber Furnaces for Annealing and Hardening	43
Annealing and Protective Gas Boxes, Additional Equipment for Models N 7/H - N 641/13	44
Stainless Steel Heat Treating Foil to avoid Surface Reactions	50
Annealing and Heat Treating Foils	50
Accessory Equipment for Processing Bags, Envelopes and Foils	50
Annealing Envelopes	51
Annealing Bags	51
Carburizing Granulate	52
Nitriding Powder and Activator	52
Chamber Furnaces with Brick Insulation or Fiber Insulation	54
Protective Gas Boxes, Additional Equipment for Models LH 15/.. - LH 216/..	56
Chamber Furnaces with Drawer Bottom or as a Bogie	58
Protective Gas Boxes and Hoods for Chamber Furnaces NW 150 - NW 1000	59
Forced Convection Chamber Furnaces < 675 Liters	60
Protective Gas Boxes, Additional Equipment for Models NA 30/45 - N 500/85HA	62
Sealed Forced Convection Chamber Furnaces NA-I and NA-SI	65
Forced Convection Pit-Type Furnaces	66
Protective Gas Boxes, Additional Equipment for Models SAL 30/45 - SAL 250/85	67
Temperature Measurement in Gas Supply Systems	69
TUS Measuring Frame for Protective Gas Box	69
Tool Shop Hardening Systems	70
Protective Gas Hardening System SHS 41	73
Gas Supply Systems	74
Vacuum Pump	75
Protection Clothing	76
Draw Hook, Binding Wire, Hardening Tongs	77
Cooling Platforms	78
Charging Devices with and without Cooling Fan for Models	
N 31/H - N 641/13, N 30/45 HA - N 500/85 HA, LH (LF) 15/.. - LH (LF) 216/..	78
Quenching and Cleaning Baths	80
Hardening Oil, Quench Water Additive, Detergent, Insulating Materials	82
Tailor-Made Furnace Plants	83
Process control and documentation	
Temperature Uniformity and System Accuracy	84
AMS 2750 E, NADCAP, CQI-9	85
Nabertherm controller series 500	88
MyNabertherm app	90
Functions of the standard controllers	92
Process data storage and data input via PC	93
PLC controls	95
Process data storage	96
Nabertherm control center NCC	97



Furnaces and Accessories for Heat Treatment of Metals



Chamber furnace N 7/H

Generally, metals are heat treated under protective or reaction gases or in vacuum to prevent or minimize oxidation of the components.

Nabertherm offers an extensive range of graduated solutions for the heat treatment of metals. This catalog provides a description of the different furnace concepts and the accessories that are available for the different processes.

Which Furnace is Suitable for Which Application?

Essentially, the requirements with respect to the furnace type depend on following factors:

- Required temperature range
- Charge dimensions
- Type of protective or reaction gas
- Required leak rate of the work space/required surface quality of the charge
- Safety requirements, i. e. when working under flammable gases
- Required heating and cooling times

Depending on the process requirements, adapted solutions can be offered for heat treatment, including quenching.

Sealed Furnace

Sealed furnaces are standard furnaces with a protective gas connection in which the housing is sealed and the door design is adapted. These furnaces are suitable for processes without high requirements with respect to residual oxygen, or for heat treatment of components that are to be processed afterwards.

Furnaces with Protective Gas Boxes, Protective Gas Boxes with an Evacuation Lid, or Annealing Bags

Heat treatment furnaces with protective gas boxes or annealing bags offer a good price/performance ratio and can be used for many processes that have to be carried out in a non-flammable protective or reaction gas atmosphere.

By using a protective gas box with the corresponding process gas supply, a standard furnace can be upgraded to a protective gas furnace. Depending on the type of process gas, the preflushing rate, the process flushing rate, and the condition of the box, it is possible to achieve residual oxygen concentrations in the low ppm range.

Depending on the application, the protective gas boxes are removable, remain in the furnace, or are especially designed for heat treatment of bulk materials. Annealing bags are another gassing variant.



Chamber furnace N 41/H

For charges with complex shapes or drilled holes, bulk materials, or sensitive materials, such as titanium, it is recommended to use a protective gas box with an additional evacuation lid for cold stage evacuation.

Protective gas boxes can be used in forced convection furnaces at temperatures up to 850 °C and in radiation heated furnaces for working temperatures up to 1100 °C. This catalog describes in detail the different furnace ranges and the associated accessories.

Hot-Wall Retort Furnaces

Retort furnaces are the perfect solution if the process requires a furnace chamber with a pure atmosphere. The retort is not water cooled and is therefore restricted in maximum temperature. Water cooling is used only for the door seal. Hot-wall retort furnaces can be used for maximum working temperatures of 1100 °C, and with special retort material, up to 1150 °C.

These gas tight retort furnaces are ideal for heat treatment processes that require a defined protective or reaction gas atmosphere. The compact models can also be designed for heat treatment in vacuum up to 600 °C. Equipped with corresponding safety technology, retort furnaces are also suitable for applications under reaction gases such as hydrogen.

Cold-Wall Retort Furnaces

Cold-wall retort furnaces can be used for heat treatment processes in defined protective or reaction gas atmospheres or high temperature processes under vacuum. The VHT retort furnaces are designed as electrically heated chamber furnaces with graphite, molybdenum, tungsten, or MoSi₂ heating.

The vacuum-tight retort is completely water-cooled and allows for heat treatment processes either in protective or reaction gas atmospheres or under vacuum up to 10⁻⁵ mbar.

This furnace series can also be equipped with suitable safety packages for flammable gases.

Furnaces for Continuous Processes

Nabertherm also has compact furnaces for continuous processes that require a protective or reaction gas atmosphere.



Forced convection chamber furnace
N 250/85 HA with protective gas box



Retort furnace VHT 100/16-MO



Retort furnace NRA 25/06

Which Furnace for Which Process?

This catalog describes furnaces working under non-flammable or flammable gases or under vacuum. For furnaces working under air please see our catalog „Thermal Process Technology I“.

Preheating for Forging

Hardening, Annealing

Quenching

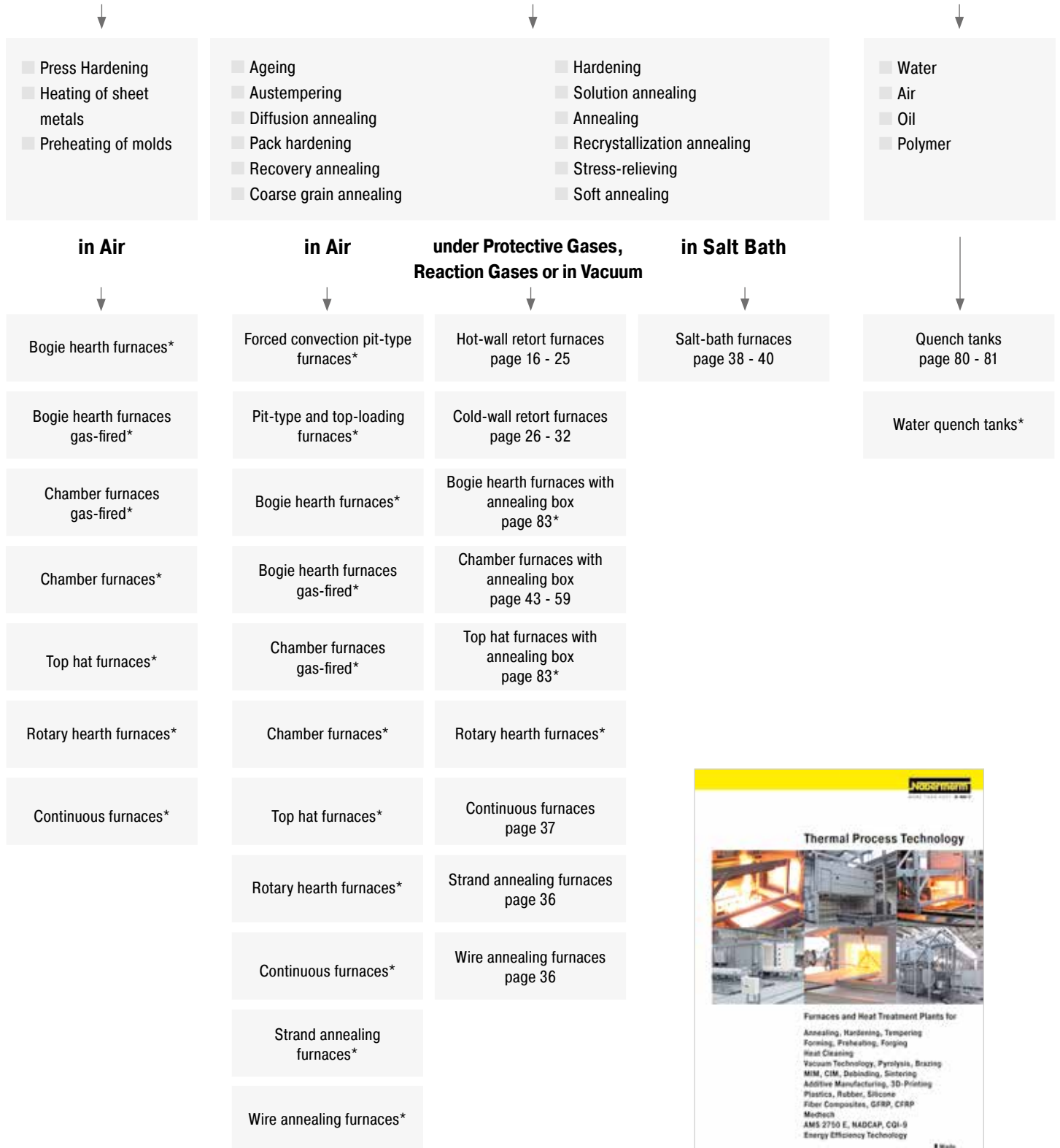

* See also catalog Thermal Process Technology I

Tempering, Annealing

Tempering Plants

- Tempering
- Precipitation annealing
- Ageing annealing
- Recovery annealing
- Solution annealing
- Preheating
- Reduced hydrogen annealing

- Solution annealing
- Quenching
- Artificial ageing

in Air

under Protective Gases, Reaction Gases or in Vacuum

in Salt Bath

Chamber dryers*

Hot-wall retort furnaces
page 16 - 25

Martempering furnaces
page 41

Tool shop hardening
systems, page 70 - 72

Forced convection chamber
furnaces > 560 liters*

Forced convection chamber
furnaces with annealing
box, page 60 - 64

Protective gas hardening
system, page 73

Forced convection chamber
furnaces < 675 liters
page 60 - 61*

Forced convection chamber
furnaces with clean room
technology*

Hot-wall retort protective
gas hardening system
page 20

Forced convection chamber
furnaces with clean room
technology*

Sealed forced convection
chamber furnaces
page 65

Fully automatic tempering
plant*

Forced convection bogie
hearth furnaces*

Forced convection bogie
hearth furnaces with
annealing box, page 83*

Manual tempering plant*

Forced convection pit-type
furnaces
page 66 - 68

Forced convection pit-type
furnaces with annealing
box, page 66 - 68*

Pit-type and top-loading
furnaces*

Rotary hearth furnaces*

Rotary hearth furnaces*

Continuous furnaces
page 37

Continuous furnaces*

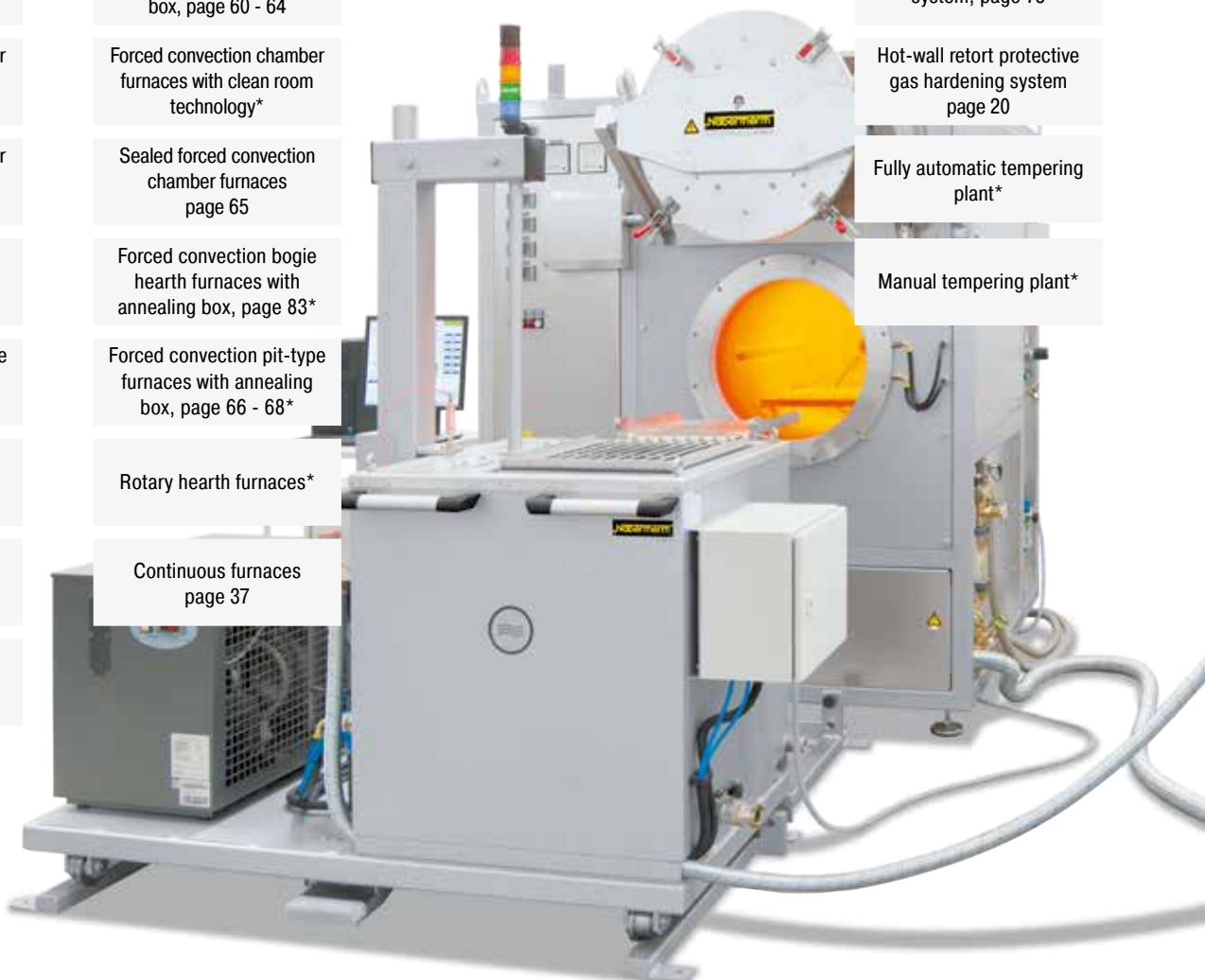

Semi-automatic tempering plant with retort furnace NR 50/11 and water quenching

Which Furnace for Which Process?

Brazing/Soldering

Curing, Tempering, Drying

- Soft soldering
- Brazing
- High-temperature brazing
- Dip brazing of steel

- Composites
- Molds
- Adhesive
- Plastics
- Lacquers
- PTFE
- Silicone
- Surface Drying
- Preheating
- Vulcanizing
- Conditioning

in Salt Bath

in Vacuum

under Protective Gases

Solvent Based

Water Based

↓	↓	↓	↓	↓
Salt-bath furnaces page 38 - 40	Hot-wall retort furnaces page 16 - 25	Hot-wall retort furnaces page 16 - 25	Hot-wall retort furnaces page 16 - 25	Chamber dryers*
	Cold-wall retort furnaces page 26 - 32	Cold-wall retort furnaces page 26 - 32	Chamber dryers*	Forced convection chamber furnaces page 60 - 61*
	Tube furnaces page 34 - 35**	Tube furnaces page 34 - 35**	Forced convection chamber furnaces NA .. LS* page 60 - 61	Ovens*
		Forced convection chamber furnaces with annealing box, page 60 - 64		Forced convection bogie hearth furnaces*
		Chamber furnaces with annealing box, page 43 - 59		Forced convection pit-type furnaces page 60 - 68*
		Forced convection pit-type furnaces with annealing box, page 66 - 68		Rotary hearth furnaces*
				Continuous furnaces*

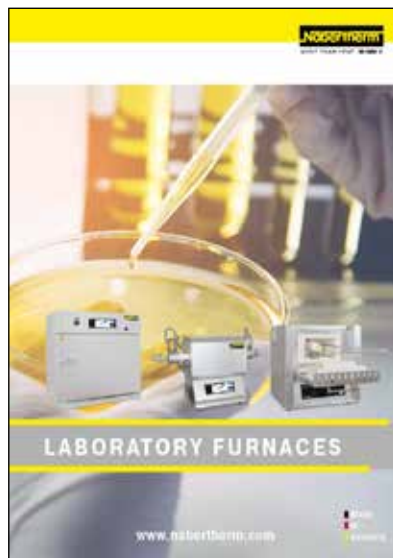
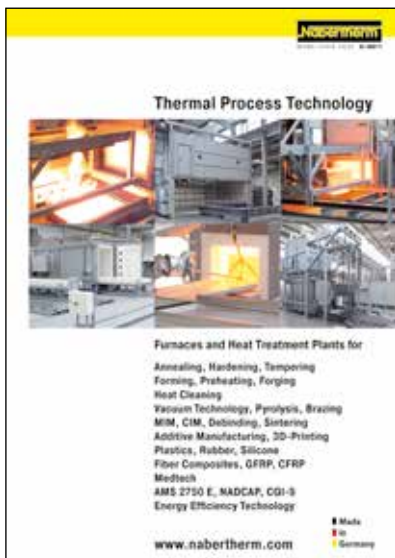

* See also catalog Thermal Process Technology

** See also catalog Laboratory

*** See also catalog Advanced Materials

Thermal/Thermo-Chemical Processes Surface Treatment, Cleaning

Sintering & Debinding

- Carburizing
- Blueing (e.g. with water steam)
- Nitriding/nitrocarborizing
- Boriding
- Deoxidizing under hydrogen
- Pyrolysis
- Heat cleaning
- Oxidizing
- Siliconizing

- Additive manufacturing
- Debinding
- MIM
- CIM
- Sintering

in Powders

under Protective Gases, Reaction Gases

in Salt Bath

in Air

under Protective Gases, Reaction Gases or in Vacuum

Hot-wall retort furnaces
page 16 - 25

Hot-wall retort furnaces
page 16 - 25

Salt-bath furnaces
page 38 - 40

Chamber furnaces***

Hot-wall retort furnaces
page 16 - 25

Cold-wall retort furnaces
page 26 - 32

Cold-wall retort furnaces
page 26 - 32

Chamber furnaces
gas-fired***

Cold-wall retort furnaces
page 26 - 32

Forced convection
chamber furnaces
page 60 - 61

Forced convection chamber
furnaces with annealing
box, page 60 - 64

Forced convection chamber
furnaces NA .. LS*
page 60 - 61

Retort furnaces for
catalytic debinding
page 21

Bogie hearth furnaces
page 83*

Forced convection bogie
hearth furnaces with
annealing box, page 83*

Forced convection
chamber furnaces with
annealing box***

Chamber furnaces
page 43 - 59*

Bogie hearth furnaces with
annealing box
page 83*

Top hat furnaces
page 83*

Chamber furnaces with
annealing box
page 43 - 59

Thermal Separation Processes

Process	..DB.. Debinding and sintering in oxidising atmosphere	..LS Debinding and sintering in oxidising atmosphere	..IDB.. Debinding inert atmos- phere	NB..CL Heat Clea- ning in inert atmosphere	..BO Heat Cleaning in oxidising atmosphere	NB..WAX Dewaxing and burn off
Avoid igniting	✓	✓	✓	✓		
Provoke igniting					✓	✓
Diluted atmosphere	✓	✓				
Inerted atmosphere			✓	✓		
Open combustion					✓	✓
O ₂ content	≥ 20 %	≥ 20 %	0-3 %	≤ 3 %	<> 20 % varies	<> 20 % varies
Vaporisation speed	slow	fast	slow	slow - fast	slow - fast	very fast
Loading / unloading	cold/cold	cold/cold hot/hot	cold/cold	cold/cold	cold/cold	> 750 °C/ > 750 °C
Tmax	1800 °C	450 °C	850 °C	500 °C	1400 °C	850 °C
Electrically heated	✓	✓	✓		✓	
Gas-fired				✓	✓	✓
External TNV	✓	(✓)	✓		✓	
Internal TNV				✓	✓	✓
External KNV	✓	(✓)	(✓)			



Blueing of drills in water steam atmosphere in a furnace of the NRA range see page 16

Hardening, Carburizing, Nitriding, Brazing, MIM



Hot-wall retort furnace NR 50/11 with semi-automatic quenching device for hardening of steel or titanium

Hardening

Hardening is one of the most common forms of heat treatment of metallic materials, with the aim of increasing mechanical resistance by converting the microstructure.

The hardness and strength increase resulting from the hardening are the main reasons for the increased resistance against wear, tension, pressure and bending.

Hardening is generally understood to mean the transformation hardening, i.e. austenitization of the material followed by quenching. When quenching, the critical cooling rate of the respective material must be exceeded in order to obtain a martensitic structure. The quenching is carried out in different quenching media (water, air, oil or gas).

Depending on the application, the material is allowed to quench, for example to obtain the desired toughness, and the hardness is again reduced.



Protective gas hardening system SHS 41

Carburizing

Steels with a low content of carbon can usually be poorly cured. By increasing the carbon content to a certain percentage, the hardenability can be significantly improved. This property is used for carburizing. The edge layer is enriched with carbon so that this carburized part of the material can subsequently be cured. The non-edge, non-carburized area of the material remains tough and soft. A known example of this process is the carburizing and subsequent hardening and tempering (case hardening) of gears wheels for all types of gearing. The toothings has the necessary hardness after the hardening in order to minimize wear, but the core of the gear wheel remains ductile and machinable.

Nitriding

As in carburizing, nitriding is also a thermochemical treatment. During nitriding, nitrogen diffuses into the edge layer. Depending on the steel or cast alloy, an increase in hardness can be achieved. A greater advantage of nitriding is the achievement of a wear-resistant edge layer. For low-alloy steels the corrosion resistance can be significantly increased by nitriding.

Carburizing and nitriding can be carried out with solid, gaseous or liquid media.

The following furnace concepts are suitable for curing, carburizing and nitriding:

Hardening

- Hardening in the protective gas box/protective gas annealing bag or annealing box in chamber furnaces with or without protective gas atmosphere. The quenching can take place in different media like oil, water or air.
- Hardening in the hot-wall retort furnace with protective gas or reaction gas up to 1150 °C. The quenching is done manually or semi-automatically in oil, water or air.

Carburizing/Nitriding

- Carburizing/nitriding in the annealing box with appropriate granulates
- Controlled or uncontrolled nitriding/carburizing in the hot-wall retort furnace with combustible reaction gases. The quenching is done manually or semi-automatically in oil, water or air.

Annealing

- Annealing in a forced convection chamber furnace with or without a protective gas atmosphere
- Annealing in the protective gas box in a forced convection chamber furnace under protective gas atmosphere



Forced convection furnace N 250/85 HA with annealing box



Retort furnace NRA 50/09 H₂

Powder-Pack Annealing Processes

As a cost-effective alternative to the thermochemical processes which take place in a gas atmosphere, the powder packing annealing is suitable for certain processes.

With this method, the parts, which are appropriately prepared, are charged into an annealing box together with the process powder. The annealing boxes are then closed with a cover.

Possible application examples are carburizing, neutralizing, nitriding or boriding.

Brazing

In general, when speaking of brazing it has to be distinguished between soft-soldering, brazing and high-temperature brazing. This involves a thermal process for forming substance-to-substance bonds and material coatings during which a liquid phase is generated by the melting of the solder. Based on their melting temperatures, the solder processes are classified as follows:

Soft-solders: $T_{liq} < 450\text{ °C}$

Brazing: $T_{liq} > 450\text{ °C} < 900\text{ °C}$

High-temperature brazing: $T_{liq} > 900\text{ °C}$

Beside the right selection of the solder, the flux if necessary, and ensuring that the surfaces are clean, the choice of the right brazing furnace is also key to the process. In addition to the actual brazing process, Nabertherm has furnaces for the preparation process in their range such as for metallizing ceramics in preparation for brazing ceramic-to-metal bonds.

The following furnace concepts are available for brazing:

- Brazing in an annealing box in the forced convection chamber furnace up to 850 °C in a protective gas atmosphere
- Brazing in an annealing box in a chamber furnace up to 1100 °C under a protective gas atmosphere
- Brazing in a hot-wall retort furnace NR/NRA product line under protective gases or reaction gas up to 1100 °C
- Brazing in a cold-wall retort furnace VHT product line under protective gases, reaction gases or under vacuum up to 2200 °C
- Brazing in a salt bath up to 1000 °C salt bath temperature
- Brazing or metallizing in a tube furnace up to 1800 °C under protective gases, reaction gases or in a vacuum up to 1400 °C

In the Nabertherm Test Center in Lilienthal, Germany, a range of sample furnaces is available for customers testing applications which is the best approach to define the right furnace for a specific application.

MIM - Metal Powder Injection Molding

The metal powder injection molding is based on the same principle as the plastic injection molding. At MIM, a metallic feedstock, i.e. a metallic powder with a binder system, is produced by means of an injection molding machine and an injection mold. The result is a so-called green part, which does not yet have its final size and density.

In the subsequent debinding process, which takes place under metallic conditions either under an inert atmosphere, under hydrogen or else catalytically under a nitric acid-nitrogen atmosphere, the green part loses a large proportion of the binder.

In the subsequent sintering process, which is also carried out again in a protective gas or reaction gas atmosphere or in a vacuum, the brown part is sintered to the finished component, which in most cases does not have to be further processed.

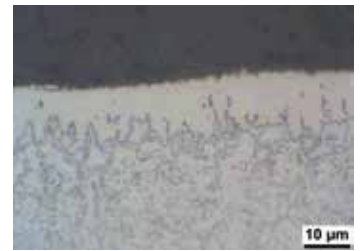

Close-up of a metallographic section of a powder-borated hot-work steel



Brazing in annealing box



Retort furnace NRA 40/02 with cupboard for the acid pump



Retort furnace VHT 40/16-MO H₂ with hydrogen extension package and process box

Additive Manufacturing, 3D-Printing



Retort furnace NR 150/11 for annealing of metal parts of 3D-printing

Additive manufacturing allows for the direct conversion of design construction files fully functional objects. With 3D-printing objects from metals, plastics, ceramics, glass, sand or other materials are built-up in layers until they have reached their final shape.

Depending on the material, the layers are interconnected by means of a binder system or by laser technology.

Many methods of additive manufacturing require subsequent heat treatment of the manufactured components. The requirements for the furnaces for heat treatment depend on the component material, the working temperature, the atmosphere in the furnace and, of course, the additive production process.

Nabertherm offers solutions from curing for conservation of the green strength up to sintering in vacuum furnaces in which the objects of metal are annealed or sintered.



Oven TR 240 for drying of powders



Chamber oven KTR 2000 for curing after 3D-printing



Compact tube furnace for sintering or annealing under protective gases or in a vacuum after 3D-printing



HT 160/17 DB200 for debinding and sintering of ceramics after 3D-printing

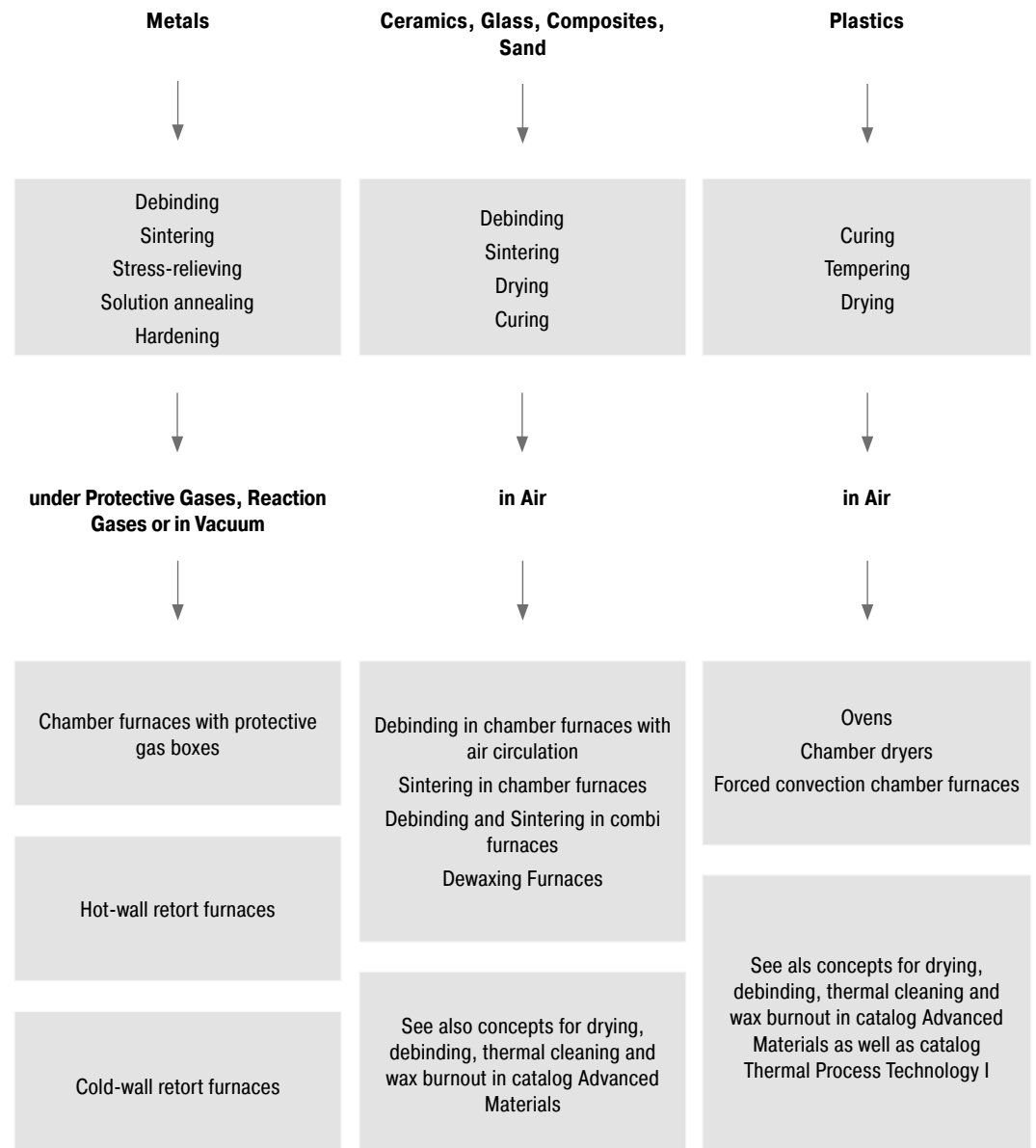

Also, concomitant or upstream processes of additive manufacturing require the use of a furnace in order to achieve the desired product properties, such as heat treatment or drying the powder.

In additive manufacturing, a distinction is made between printing with and without binder. Depending on the manufacturing process, different furnace types are used for the subsequent heat treatment.

Apart from the factors described above, the previous processes from the heat treatment also have an influence on the overall result. One important criteria for a good surface quality is that the components are cleaned properly before the heat treatment.

This also applies to processes that are carried out in vacuum or in furnaces where a low residual oxygen concentration is important. For these furnaces, it is important that they are cleaned and maintained regularly. Even the smallest leak or contamination can produce an unsatisfactory result.



Printed aluminum part, heat treated in model N 250/85 HA (Manufacturer CETIM CERTEC on SUPCHAD platform)

Binder-Free Systems

In binder-free additive manufacturing, in most cases, the components are produced in a laser melting process.

The tables below show typical materials and construction platform sizes of laser-based systems that are available on the market with suggestions with respect to furnace sizes, required temperature and atmosphere in the furnace.

Aluminum Components

Generally, aluminum is heat treated in air at temperatures between 150 °C and 450 °C.

Due to the very good temperature uniformity, forced convection chamber furnaces are suitable for processes such as tempering, aging, stress-relieving or preheating.

Examples for max platform sizes	Forced convection chamber furnaces, see page 60 up to 450 °C ¹
210 x 210 mm	NA 30/45
280 x 280 mm	NA 60/45
360 x 360 mm	NA 120/45
480 x 480 mm	NA 250/45
600 x 600 mm	NA 500/45

¹Also available for 650 °C and 850 °C



Forced convection chamber furnace NA 250/45 for heat treatment in air

Stainless Steel and Titanium Components

In many cases, certain stainless steels and titanium are heat treated in a protective gas atmosphere at temperatures below 850 °C.

By using a protective gas box with the corresponding process gas supply, a standard furnace can be upgraded to a protective gas furnace. Depending on the type of process gas, the preflushing rate, the process flushing rate, and the condition of the box, it is possible to achieve residual oxygen concentrations of up to 100 ppm.

The forced convection chamber furnaces with protective gas boxes described below have a working temperature range between 150 °C and 850 °C. If the protective gas boxes are removed from the furnace, aluminum components can also be heat treated in air.

Examples for platform sizes	Forced convection chamber furnaces, see page 60 up to 850 °C with protective gas box
100 x 100 mm	N 30/85 HA
200 x 200 mm	N 60/85 HA
280 x 280 mm	N 120/85 HA
400 x 400 mm	N 250/85 HA
550 x 550 mm	N 500/85 HA



Forced convection chamber furnace N 250/85 HA with protective gas box for heat treatment in a protective gas atmosphere



Hot-wall retort furnace NRA 150/09 for heat treatment in a protective gas atmosphere

With sensitive materials, such as titanium, the component may still oxidize due to the residual oxygen concentration in the protective gas box.

In these cases, hot-wall retort furnaces with a maximum temperature of 950 °C or 1100 °C are used. These gas tight retort furnaces are ideal for heat treatment processes that require a defined protective or reaction gas atmosphere. The compact models can also be designed for heat treatment under vacuum up to 600 °C. The risk of oxidation on the component is considerably reduced with these furnaces.

Examples for platform sizes	Hot-wall retort furnaces see page 16
180 x 180 mm	NR(A) 17/..
280 x 280 mm	NR(A) 50/..
400 x 400 mm	NR(A) 150/..



Titanium rods after heat treatment in NR 50/11 in argon atmosphere



Chamber furnace LH 60/12 with protective gas box for heat treatment in a protective gas atmosphere

Inconel or Cobalt-Chromium Components

Materials such as Inconel and cobalt-chromium are generally heat treated at temperatures from 850 °C up to between 1100 °C and 1150 °C. Various furnace families are used for these processes. In many cases, the chamber furnaces of the LH .. or NW .. series with protective gas boxes are sufficient to provide an outstanding price/performance ratio. Both furnace groups are suitable for temperatures between 800 °C and 1100 °C.

Examples for platform sizes	Chamber furnaces see page 54 and 58 up to 1100 °C with protective gas box
100 x 100 mm	LH 30/12
250 x 250 mm	LH 120/12
400 x 400 mm	LH 216/12
420 x 520 mm	NW 440
400 x 800 mm	NW 660



Cold-wall retort furnace VHT 100/12-MO for processes in high vacuum

Cold-wall retort furnaces are used for processes in protective gas at temperatures above 1100 °C or under vacuum above 600 °C.

Examples for platform sizes	Cold-wall retort furnaces see page 26
100 x 100 mm	VHT 8/12-MO
250 x 250 mm	VHT 40/12-MO
400 x 400 mm	VHT 100/12-MO

Systems with Binder

In 3D printing, organic binders, which evaporate during heat treatment, are used to build-up the part. The printed parts can be made of ceramic, metal, glass or sand. Depending on the evaporation volume, furnaces with graduated safety systems for debinding and sintering are used.

Debinding and Sintering in Air

This table shows examples of furnaces with the respective safety technology for debinding in air and the corresponding sintering furnaces for high temperatures, which are suitable, for example, for sintering many oxide ceramics.

Printing dimensions up to	Debinding furnaces ¹ see catalog Advanced Materials	Sintering furnaces ² see catalog Advanced Materials
100 x 100 x 100 mm	L 9/11 BO	LHT 4/16
200 x 200 x 150 mm	L 9/11 BO	HT 40/16
300 x 400 x 150 mm	L 40/11 BO	HT 64/17

¹ Values for debinding like max. organic content, or evaporation rate have to be considered

² The furnaces are available with different max. furnace chamber temperatures



Muffle furnace L 40/11 BO with passive safety system and integrated post combustion for thermal debinding in air

Debinding and Sintering in Protective or Reaction Gas or under Vacuum

To protect metal components that were printed using a binder-based system against oxidation, two process steps, debinding and sintering, are carried out in an oxygen-free atmosphere.

Depending on the material and the binder system, debinding is carried out either in a non-flammable protective gas (IDB), under hydrogen (H₂), or catalytically in a mixture of nitric acid and nitrogen. Adapted safety systems are used to ensure the safety of these processes.

The table contains examples of furnaces which can be equipped with suitable safety technology. Hot-wall retort furnaces are used as debinding furnaces and cold-wall retort furnaces as sintering furnaces. Under certain circumstances, depending on the application, it is possible to use the same furnace for both processes.



High-temperature furnace HT 64/17 DB100 with passive safety system for debinding and sintering in air

Printing dimensions up to	Hot-wall retort furnaces ¹ see page 16	Cold-wall retort furnaces ² see page 26
150 x 150 x 150 mm	NRA 17/09	VHT 8/16-MO
300 x 300 x 300 mm	NRA 50/09	VHT 40/16-MO
400 x 400 x 400 mm	NRA 150/09	VHT 100/16-MO

¹ Safety systems see page 18

² Parts without residual binder. In case of a low content of residual binder we recommend an inner process chamber.

The models listed in the table above are just a few examples.

Hot-Wall Retort Furnaces up to 1100 °C

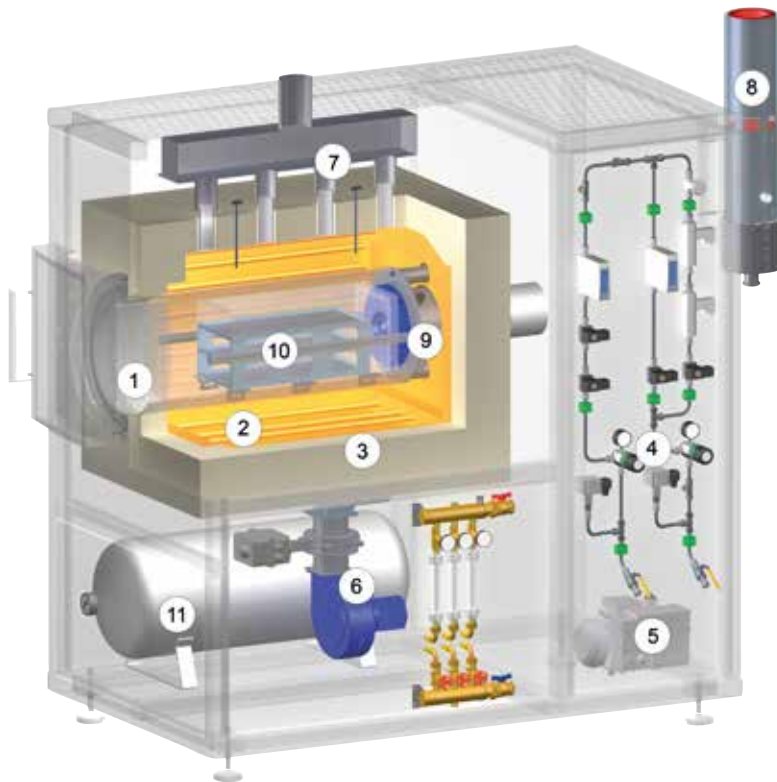

Schematic presentation of a hot-wall retort furnace with additional equipment

- 1 Retort
- 2 Heating
- 3 Insulation
- 4 Gas management system
- 5 Vacuum pump
- 6 Fan for indirect cooling
- 7 Outlet indirect cooling
- 8 Exhaust torch
- 9 Fan for gas circulation (NRA models)
- 10 Charging frame
- 11 Emergency flushing container

These gas tight retort furnaces are equipped with direct or indirect heating depending on temperature. They are perfectly suited for various heat treatment processes requiring a defined protective or a reaction gas atmosphere. These compact models can also be laid out for heat treatment under vacuum up to 600 °C. The furnace chamber consists of a gas tight retort with water cooling around the door to protect the special sealing. With the corresponding safety technology, retort furnaces are also suitable for applications under reaction gases, such as hydrogen or, in combination with the IDB package, for inert debinding or for pyrolysis processes.



Inside heating in retort furnace NRA ../06

Different model versions are available depending on the temperature range :

Models NRA ../06 with Tmax 650 °C

- Heating elements located inside the retort
- Temperature uniformity up to +/- 5 °C inside the work space see page 84
- Retort made of 1.4571
- Gas circulation fan in the back of the retort provides for optimal temperature uniformity
- Insulation made of mineral wool

Models NRA ../09 with Tmax 950 °C

Design like models NRA ../06 with following differences:

- Outside heating with heating elements around the retort
- Retort made of 1.4828
- Only fiber materials are used which are not classified as carcinogenic according to TRGS 905, class 1 or 2

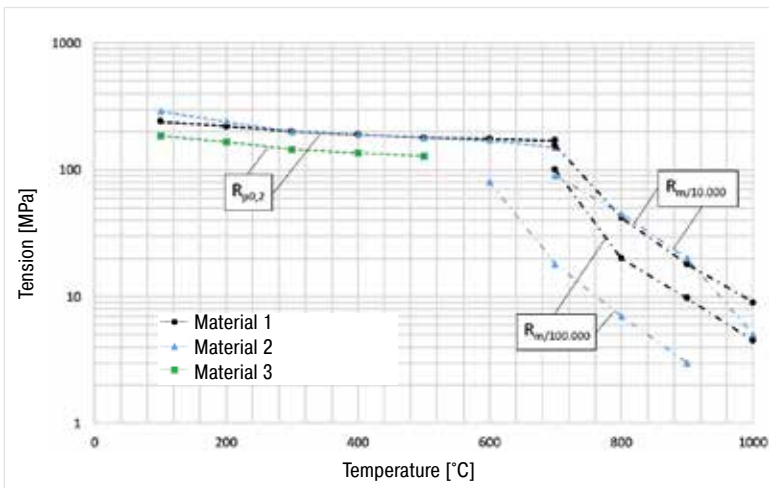

Short and long-term durability of retort materials

Models NR ../11 with Tmax 1100 °C

Design like models NRA ../09 with following differences:

- Retort made of 1.4841
- Without gas-circulation



Retort furnace NRA 25/09



Retort furnace NRA 150/09 with controls H1700 and bayonet door lock

Basic version

- Compact housing in frame design with removable stainless steel sheets
- Controls and gas supply integrated in the furnace housing
- Welded charging supports in the retort resp. air-baffle box in the furnaces with atmosphere circulation
- Swivel door hinged on right side
- Open cooling water system
- Depending on furnace volume for 950 °C- and 1100 °C-models the control system is divided in one or more heating zones
- Furnace temperature control with measurement outside the retort
- Gas supply system for one non-flammable protective or reaction gas with flow meter and magnetic valve
- Port for vacuum pump for cold evacuation
- Operation under vacuum up to 600 °C with optional vacuum pumps
- Defined application within the constraints of the operating instructions
- NTLog Basic for Nabertherm controller: recording of process data with USB-flash drive
- Controls description see page 88

Additional equipment

- Upgrade for other non-flammable gases, H₂ version for flammable gases see page 18
- Automatic gas injection, including MFC flow controller for alternating volume flow, controlled with process control H3700, H1700
- Vacuum pump for evacuating of the retort up to 600 °C, attainable vacuum up to 10⁻⁵ mbar subject to selected pump
- Indirect cooling see page 33
- Direct cooling see page 33
- Heat exchanger with closed-loop cooling water circuit for door cooling
- Measuring device for residual oxygen content
- Door heating
- Temperature control as charge control with temperature measurement inside and outside the retort
- Retort, made of 2.4633 for T_{max} 1150 °C
- Process control and documentation via VCD software package or Nabertherm Control Center (NCC) for monitoring, documentation and control see page 88



Vacuum pump for cold evacuation of the retort

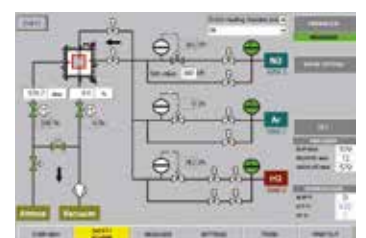

Process control H3700 for automatic version

Hot-Wall Retort Furnaces up to 1100 °C



Retort furnace NRA 400/03 IDB with thermal post combustion system

IDB Version for Debinding under Non-flammable Protective Gases or for Pyrolysis Processes

The retort furnaces of the NR and NRA product line are perfectly suited for debinding under non-flammable protective gases or for pyrolysis processes. The IDB version of the retort furnaces implements a safety concept by controlled inerting the furnace chamber with a protective gas. Exhaust gases are burned in a thermal post combustion. Both the purging and the torch function are monitored to ensure a safe operation.

- Process control under monitored overpressure
- Process control H1700 with PLC controls and graphic touch panel for data input
- Monitored gas pre-pressure of the process gas
- Bypass for safe flushing of furnace chamber with inert gas
- Thermal post combustion of exhaust gases



Retort furnace NRA 300/09 H₂ for heat treatment under hydrogen

H₂ Version for Operation with Flammable Process Gases

When a flammable process gas like hydrogen is used, the retort furnace is additionally equipped with the required safety technology. Only certified and industry proven safety sensors are used. The furnace is controlled by a fail-safe PLC control system (S7- 300F/safety controller).

- Supply of flammable process gas at controlled overpressure of 50 mbar relative
- Certified safety concept
- PLC controls with graphic touch panel H3700 for data input
- Redundant gas inlet valves for hydrogen
- Monitored pre-pressures of all process gases
- Bypass for safe flushing of furnace chamber with inert gas
- Torch for thermal post combustion of exhaust gases
- Emergency flood container for purging the furnace in case of failure



Charging of the retort furnace NRA 300/06 with a pallet truck

Model	Tmax °C	Model	Tmax °C	Work space dimensions in mm			Useful volume in l	Electrical connection*
				w	d	h		
NRA 17/..	650 or 950	NR 17/11	1100	225	350	225	17	3-phase
NRA 25/..	650 or 950	NR 25/11	1100	225	500	225	25	3-phase
NRA 50/..	650 or 950	NR 50/11	1100	325	475	325	50	3-phase
NRA 75/..	650 or 950	NR 75/11	1100	325	700	325	75	3-phase
NRA 150/..	650 or 950	NR 150/11	1100	450	750	450	150	3-phase
NRA 200/..	650 or 950	NR 200/11	1100	450	1000	450	200	3-phase
NRA 300/..	650 or 950	NR 300/11	1100	590	900	590	300	3-phase
NRA 400/..	650 or 950	NR 400/11	1100	590	1250	590	400	3-phase
NRA 500/..	650 or 950	NR 500/11	1100	720	1000	720	500	3-phase
NRA 700/..	650 or 950	NR 700/11	1100	720	1350	720	700	3-phase
NRA 1000/..	650 or 950	NR 1000/11	1100	870	1350	870	1000	3-phase

*Please see page 89 for more information about supply voltage



Hot-wall retort furnace NRA 1700/06 with charging frame. For grey room/clean room installation for heat treatment of glass under protective gases.

With their high level of flexibility and innovation, Nabertherm offers the optimal solution for customer-specific applications.

Based on our standard models, we develop individual solutions also for integration in overriding process systems. The solutions shown on this page are just a few examples of what is feasible. From working under vacuum or protective gas via innovative control and automation technology for a wide selection of temperatures, sizes, lengths and other properties of retort furnaces – we will find the appropriate solution for a suitable process optimization.

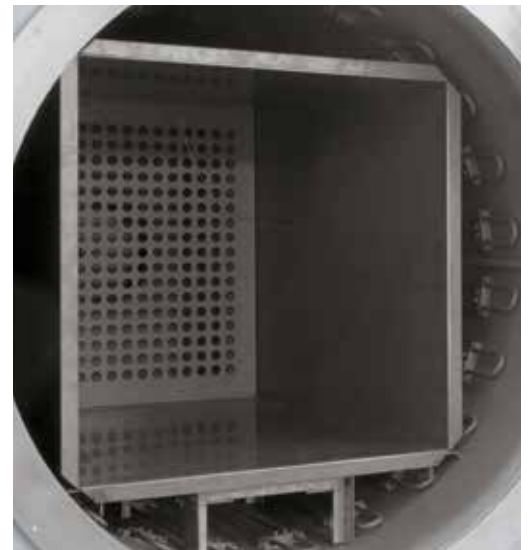

Hot-wall retort furnace NRA 1700/06 for steel annealing under nitrogen



Hot-wall retort furnace NRA 3300/06 with automatic door opening for the integration in a fully automatic quench & temper plant

Manual or Semi-Automatic Tempering Plants for Hardening in Protective Gas with Subsequent Quenching outside the Furnace

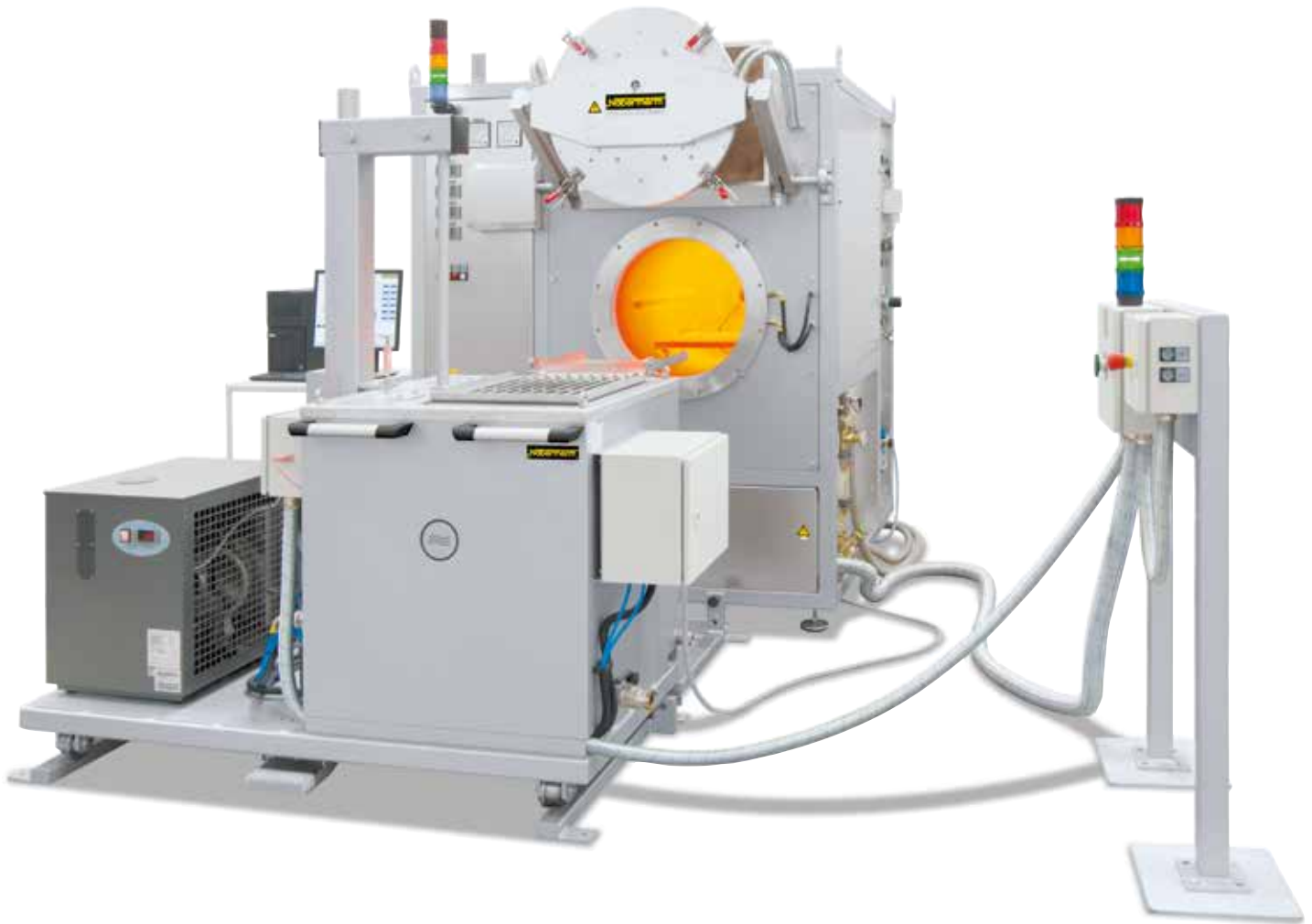

Semi-automatic annealing plant with retort furnace NR 50/11 and water quenching bath on rails

Processes such as hardening of titanium or hardening/carburization, carburizing of steel, which require a controlled gas atmosphere with a subsequent quenching process, can be carried out with protective gas quenching and tempering plants. Such a system consists of a hot-wall retort furnace and an external quenching bath. Depending on the arrangement and design of the components, quenching delay times of up to 10 seconds can be achieved, so that the components are exposed to air for a short time only.

Chamber retort furnaces or pit-type retort furnaces can be offered for heavy components, where the batch is removed by crane after heat treatment and transferred to the quenching bath.

Depending on the requirements, the degree of automation can range from a purely manual version to a fully automated system with manipulator.

The quenching medium shall be selected taking into account the material to be treated and may be water, polymer, oil or a salt.

Additional equipment required for the process, such as cooling or heating or circulation of the medium, can be offered as well.

In a manual quenching and tempering plant, the process control is carried out by means of a Nabertherm controller. For more complex requirements, the controller is replaced by a PLC control. Process documentation in accordance with current standards such as the AMS 2750 E (NADCAP) is also possible.



NR 50/11 with charging rack for manual removal at high temperatures for quenching in an external bath

Retort Furnaces for Catalytic Debinding also as Combi Furnaces for Catalytic or Thermal Debinding

The retort furnaces NRA 40/02 CDB and NRA 150/02 CDB are specially developed for catalytic debinding of ceramics and metallic powder injection molded parts. They are equipped with a gastight retort with inside heating and gas circulation. During catalytic debinding, the polyacetal-containing (POM) binder chemically decomposes in the oven under nitric acid and is carried out of the oven by a nitrogen carrier gas and burned in an exhaust gas torch. Both retort furnaces have a comprehensive safety package to protect the operator and the surrounding.

Executed as combi furnace series CTDB these retort furnace can be used for either catalytic or thermal debinding incl. presintering if necessary and possible. The presintered parts can be easily transferred into the sintering furnace. The sintering furnace remains clean as no residual binder can exhaust anymore.

- Retort made of acid-resistant stainless steel 1.4571 with large swiveling door
 - Four-side heating inside the retort through chromium steel tube heating elements for good temperature uniformity
 - Horizontal gas circulation for uniform distribution of the process atmosphere
 - Acid pump and acid vessel (to be provided by the customer) accommodated in the furnace frame
 - Gas-fired exhaust gas torch with flame monitoring
-
- Extensive safety package with redundantly operating safety PLC for safe operation with nitric acid
 - Large, graphic process control H3700 for entering data and for process visualization
 - Emergency tank for flushing in case of a failure
 - Defined application within the constraints of the operating instructions

Version NRA .. CDB

- Tmax 200 °C
- Automatic gas supply system for nitrogen with mass flow controller
- Adjustable acid volume and correspondingly adjusted gas supply volumes

Version NRA .. CTDB

- Available for 600 °C and 900 °C with atmosphere circulation

Additional equipment

- Scale for the nitric acid vessel, connected to the PLC monitors the acid consumption and visualizes the fill level of the acid vessel (NRA 150/02 CDB)
- Lift truck for easy loading of the furnace
- Cupboard for acid pump
- Process control and documentation via Nabertherm Control Center (NCC) for monitoring, documentation and control see page 88



Retort furnace NRA 40/02 with cupboard for the acid pump



Acid pump for nitric acid



Retort with internal heating

Model	Tmax °C	Inner dimensions in mm			Volume in l	Outer dimensions in mm			Heating power in kW ²	Electrical connection*	Weight in kg	Acidic quantity (HNO ₃)	Nitrogen (N ₂)
		w	d	h		W	D	H					
NRA 40/02 CDB	200	300	450	300	40	1400	1600	2400	2,0	3-phase ¹	800	max. 70 ml/h	1000 l/h
NRA 150/02 CDB	200	450	700	450	150	1650	1960	2850	20,0	3-phase ¹	1650	max. 180 ml/h	max. 4000 l/h

¹Heating only between two phases

²Depending on furnace design connected load might be higher

*Please see page 89 for more information about supply voltage

Bottom Loading Retort Furnaces up to 1100 °C



Bottom loading retort furnace
LBR 300/11 H₂ with safety technology for
operation with Hydrogen as process gas



Gas management system at
bottom loading retort furnace
LBR 300/11 H₂

The bottom loading retort furnaces of the LBR series are suitable for production processes that are carried out in protective/reaction gas atmosphere. With regard to the basic performance data, these models are constructed like the SR models. Their size and design with electro-hydraulically driven lifting bottom make it easier to load heavy duties. The retort furnaces are available in different sizes and designs.



Basic version (all models)

- Tmax 650 °C, 950 °C or 1100 °C
- Frame-mounted housing with stainless steel sheets
- Charging from the front
- Electro-hydraulically driven furnace bottom
- Gas supply system for a non-flammable protective gas or reaction gas with flow meter and solenoid valve
- Temperature control designed as furnace chamber control, see control alternative page 87
- Connection possibility for an optional vacuum pump (cold evacuation or operation up to 600 °C under vacuum)
- Defined application within the constraints of the operating instructions
- NTLog Basic for Nabertherm controllers: recording of process data with USB flash drive

Additional equipment, H₂ version and IDB version see models NR and NRA

Pit-Type Retort Furnaces up to 1100 °C

The retort furnaces SR and SRA (with gas circulation) are designed for operation under non-flammable or flammable protective or reaction gases. The hot-wall retort furnaces are loaded from above by crane or other lifting equipment provided by the customer. In this way, even large charge weights can be loaded into the furnace chamber.

Depending on the temperature range in which the furnace be used, the following models are available:

Models SRA ../06 with Tmax 600 °C

- Heating inside the retort
- Gas-circulation with powerful fan in the furnace lid
- Temperature uniformity up to +/- 5 °C inside the work space see page 84
- Single-zone control
- Retort made of 1.4571
- Insulation made of high-grade mineral wool

Models SRA ../09 with Tmax 950 °C

Design like models SR../06 with following differences:

- All-around heating from outside of the retort
- Only fiber materials are used which are not classified as carcinogenic according to TRGS 905, class 1 or 2
- Retort made of 1.4828

Models SR ../11 with Tmax 1100 °C

Design like models SR../09 with following differences:

- Without gas-circulation
- Top down multi-zone control of the furnace heating
- Retort made of 1.4841

Standard Equipment (all models)

Design like standard equipment of models NR and NRA with following differences:

- Compact housing in frame construction with inserted stainless steel sheets
- Charging from above with crane or other lifting equipment from customer
- Hinged lid with opening to the side
- Welded charging frame resp. gas-guiding box for furnaces with circulation
- Gas-supply system for one non-flammable protective or reactive gas with flowmeter and magnetic valve
- Furnace temperature control see control alternative page 87
- Possible connection of an optional vacuum pump (for cold evacuation or for processes up to 600 °C under vacuum)
- Defined application within the constraints of the operating instructions
- NTLog Basic for Nabertherm controller: recording of process data with USB-flash drive

Additional equipment, H₂ version or IDB version see models NR and NRA



Retort furnace SRA 300/06 with charging basket



Front made of textured stainless steel



Retort furnace SRA 200/09

Model	Tmax °C	Inner dimensions of alloy retort		Volume in l	Outer dimensions in mm			Electrical connection*	Weight in kg
		ø in mm	h in mm		W	D	H		
SR(A) 17/..	600, 950 or 1100	250	350	17	1300	1700	1800	3-phase	600
SR(A) 25/..		250	500	25	1300	1900	1800	3-phase	800
SR(A) 50/..		400	450	50	1400	2000	1800	3-phase	1300
SR(A) 100/..		400	800	100	1400	2000	2100	3-phase	1500
SR(A) 200/..		600	700	200	1600	2200	2200	3-phase	2100
SR(A) 300/..		600	1000	300	1600	2200	2500	3-phase	2400
SR(A) 500/..		800	1000	500	1800	2400	2700	3-phase	2800
SR(A) 600/..		800	1200	600	1800	2400	2900	3-phase	3000
SR(A) 800/..		1000	1000	800	2000	2600	2800	3-phase	3100
SR(A) 1000/..		1000	1300	1000	2000	2600	3100	3-phase	3300
SR(A) 1500/..		1200	1300	1500	2200	2800	3300	3-phase	3500

*Please see page 89 for more information about supply voltage

Forced Convection Pit-Type Retort Furnaces up to 850 °C

The forced convection pit-type furnaces of the SAL series (technical data see page 66) can be upgraded by the use of gas tight retorts for processes with defined atmospheres.

These systems are very well suited for the heat treatment of bulk materials.

By means of an additional retort and cooling station, the retort can be removed after completion of the heat treatment process and cooled in a cooling station. In the case of sensitive components, further flushing with protective gas can also be carried out during the cooling phase.

The cooling station can be designed with or without forced cooling by means of a powerful fan.

When equipped with a vacuum pump, the retort is evacuated outside the furnace in cold state and then flushed with protective gas. This procedure is particularly suitable for heat treatment of bulk solids as well as for non-ferrous and precious metals. Residual oxygen is much better and faster removed by means of pre-evacuation.

Up to a maximum working temperature of 600 °C, the furnaces can also be operated under vacuum by connecting a vacuum pump depending on the type of pump, a vacuum of up to 10^{-5} mbar can be achieved.

The furnaces can be equipped with gas supply systems for non-flammable protective and reaction gases, as described on pages 74 - 75.

Pit-type furnace SAL 30/65 with alternating retort for defined inert gas atmosphere and two retort cooling stations

A gas supply system for operation under hydrogen, including safety technology, is also available as an additional equipment.



Retort with vacuum and protective gas line, cooling water connections as well as thermocouples and pressure sensors



Cooling station without forced cooling with exchangeable retort

Pit-Type Furnace with Exchangeable Retort



Pit-type furnace SRA 450/06 with exchangeable retort

Main advantage of the pit-type furnace design is that the retort can be taken out of the furnace by crane, in order to cool down outside the furnace while the inert gas flushing is still switched on. Cooling can be carried out naturally outside the furnace on a separate cooling station or forced in a cooling station with powerful cooling fan. The throughput can be increased by using a second exchangeable retort, which is loaded and inertised before the first retort is removed.



Exchangeable retorts with supply and measuring lines



Retort furnace SR 170/1000/11 with changeable retort and cooling station

Cold-Wall Retort Furnaces up to 2400 °C



Retort furnace VHT 500/22-GR H₂ with CFC-process box and extension package for operation under hydrogen

The compact retort furnaces of the VHT product line are available as electrically heated chamber furnaces with graphite, molybdenum, tungsten or MoSi₂ heating. A wide variety of heating designs as well as a complete range of accessories provide for optimal retort furnace configurations even for sophisticated applications.



Graphite heating chamber

The vacuum-tight retort allows heat treatment processes either in protective and reaction gas atmospheres or in a vacuum, subject to the individual furnace specs to 10⁻⁵ mbar. The basic furnace is suited for operation with non-flammable protective or reactive gases or under vacuum. The H₂ version provides for operation under hydrogen or other flammable gases. Key of the specification up is a certified safety package providing for a safe operation at all times and triggers an appropriate emergency program in case of failure.

Alternative Heating Specifications

In general the following variants are available with respect to the process requirements:

VHT ...-GR with Graphite Insulation and Heating

- Suitable for processes under protective and reaction gases or under vacuum
- Tmax 1800 °C, 2200 °C or 2400 °C (VHT 40/.. - VHT 100/..)
- Max. vacuum up to 10⁻⁴ mbar depending on pump type used
- Graphite felt insulation

VHT ...-MO or VHT ...-W with Molybdenum or Tungsten Heating

- Suitable for high-purity processes under protective and reaction gases or under high vacuum
- Tmax 1200 °C, 1600 °C or 1800 °C (see table)
- Max. vacuum up to 10⁻⁵ mbar depending on pump type used
- Insulation made of molybdenum resp. tungsten radiation sheets

VHT ...-KE with Fiber Insulation and Heating through Molybdenum Disilicide Heating Elements

- Suitable for processes under protective and reaction gases, in air or under vacuum
- Tmax 1800 °C
- Max. vacuum up to 10⁻² mbar (up to 1300 °C) depending on pump type
- Insulation made of high purity aluminum oxide fiber



Molybdenum or tungsten heating chamber



Molybdenumdisilicide heater and fiber insulation

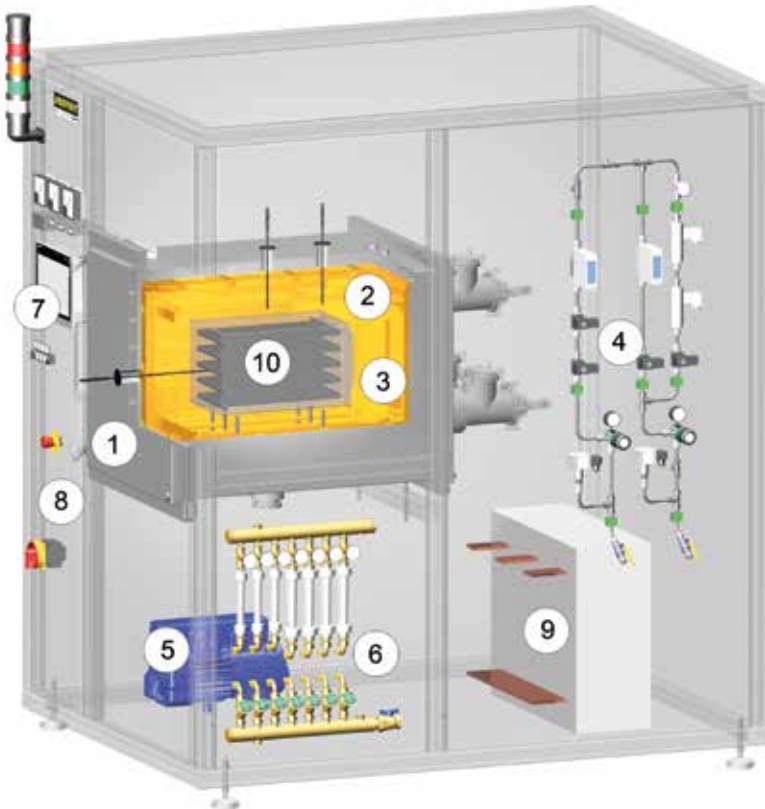

Schematic presentation of a cold-wall retort furnace with additional equipment

- 1 Retort
- 2 Heating
- 3 Insulation
- 4 Gas management system
- 5 Vacuum pump
- 6 Cooling water distribution
- 7 Controls
- 8 Integrated switchgear
- 9 Heating transformer
- 10 Charging frame inside the inner process chamber

Basic version

- Standard furnace sizes 8 - 500 liters
- Water-cooled retort made of stainless steel
- Frame made of stable steel profiles, easy to service due to easily removable stainless steel panels
- Housing of the VHT 8 model on castors for easy repositioning of furnace
- Cooling water manifold with manual tap, automatic flow monitoring, open-loop cooling water system
- Adjustable cooling water circuits with flowmeter and temperature indicator and overtemperature protection
- Switchgear and controller integrated in furnace housing
- Process control with controller P570
- Over-temperature limiter with adjustable cutout temperature for thermal protection class 2 in accordance with EN 60519-2
- Manual operation of the process gas and vacuum functions
- Manual gas supply for one process gas (N₂, Ar or non-flammable forming gas) with adjustable flow
- Bypass with manual valve for rapid filling or flooding of furnace chamber
- Manual gas outlet with overflow valve (20 mbar relative) for over-pressure operation
- Single-stage rotary vane pump with ball valve for pre-evacuating and heat treatment in a rough vacuum to 5 mbar
- Pressure gauge for visual pressure monitoring
- Defined application within the constraints of the operating instructions



Retort furnace VHT 8/16-MO with automation package



Retort furnace VHT 100/16-MO with automation package



Additional equipment housing/heater

- Housing, optionally divisible, for passing through narrow door frames (VHT 8)
- Lift door
- Individual heating concepts

Additional equipment gas management system

- Manual gas supply for second process gas (N_2 , Ar or non-flammable forming gas) with adjustable flow and bypass
- Mass flow controller for alternating volume flow and generation of gas mixtures with second process gas (only with automation package)
- Inner process box made of molybdenum, tungsten, graphite or CFC, especially recommended for debinding processes. The box is installed in the furnace with direct gas inlet and outlet and provides for better temperature uniformity. Generated exhaust gases will be directly lead out the inner process chamber during debinding. The change of gas inlet pathes after debinding results in a clean process gas atmosphere during sintering.

Retort furnace VHT 40/22-GR with motor-driven lift door and front frame for connection to a glovebox



Heat treatment of copper bars under hydrogen in retort furnace VHT 8/16-MO

Additional equipment vacuum

- Two-stage rotary vane pump with ball valve for pre-evacuating and heat-treating in a fine vacuum (up to 10^{-2} mbar) incl. electronic pressure sensor
- Turbo molecular pump with slide valve for pre-evacuation and for heat treatment in a high vacuum (up to 10^{-5} mbar) including electronic pressure sensor and booster pump
- Other vacuum pumps on request
- Partial pressure operation: protective gas flushing at controlled underpressure (only with automation package)

Additional equipment cooling

- Heat exchanger with closed-loop cooling water circuit
- Direct cooling see page 33



Thermocouple, type S with automatic pull-out device for precise control results in the low temperature range

Additional equipment for controls and documentation

- Charge thermocouple with display
- Temperature measurement at 2200 °C models with pyrometer in the upper temperature range and thermocouple, type C with automatic pull-out device for precise control results in the low temperature range (VHT 40/..-GR and larger)
- Automation package with process control H3700
 - 12" graphic touch panel
 - Input of all process data like temperatures, heating rates, gas injection, vacuum at the touch panel
 - Display of all process-relevant data on a process control diagram
 - Automatic gas supply for one process gas (N_2 , argon or non-flammable forming gas) with adjustable flow
 - Bypass for flooding and filling the chamber with process gas controlled by the program
 - Automatic pre- and post programs, including leak test for safe furnace operation
 - Automatic gas outlet with bellows valve and overflow valve (20 mbar relative) for over-pressure operation
 - Transducer for absolute and relative pressure
- Process control and documentation via VCD software package or Nabertherm Control Center (NCC) for monitoring, documentation and control see page 80



Turbo-molecular pump



Single-stage rotary vane pump for heat treatment in a rough vacuum to 5 mbar



Two-stage rotary vane pump for heat treatment in a vacuum to 10⁻² mbar



Turbo-molecular pump with booster pump for heat treatment in a vacuum to 10⁻⁵ mbar

Process Box for Debinding in Inert Gas

Certain processes require charges to be debinded in non-flammable protective or reactive gases. For these processes we fundamentally recommend a hot-wall retort furnace (see models NR .. or SR ..). These retort furnaces can ensure that the formation of condensation will be avoided as thoroughly as possible.

If there is no way to avoid the escape of small amounts of residual binder during the process, even in the VHT furnace, the retort furnace should be designed to meet this contingency.

The furnace chamber is equipped with an additional process box that has a direct outlet to the exhaust gas torch through which the exhaust gas can be directly vented. This system enables a substantial reduction in the amount of furnace chamber contamination caused by the exhaust gases generated during debinding.

Depending on the exhaust gas composition the exhaust gas line can be designed to include various options.

- Exhaust gas torch for burning off the exhaust gas
- Condensation trap for separating out binding agents
- Exhaust gas post-treatment, depending on the process, via scrubbers
- Heated exhaust gas outlet to avoid condensation deposits in the exhaust gas line



Graphite inner process chamber incl. charge holder

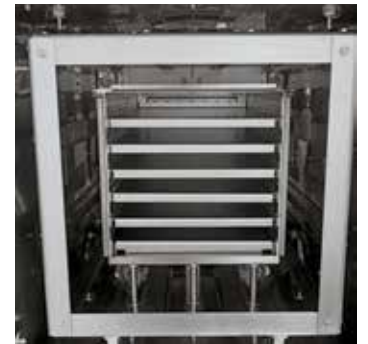

Molybdenum inner process chamber incl. six charge supports



Front made of textured stainless steel

	VHT ../.-GR	VHT ../.-MO	VHT ../18-W	VHT ../18-KE
Tmax	1800 °C, 2200 °C or 2400 °C	1200 °C or 1600 °C	1800 °C	1800 °C
Inert gas	✓	✓	✓	✓
Air/Oxygen	-	-	-	✓
Hydrogen	✓ ^{3,4}	✓ ³	✓ ³	✓ ^{1,3}
Rough vacuum and fine vacuum (>10 ⁻³ mbar)	✓	✓	✓	✓ ²
High vacuum (<10 ⁻³ mbar)	✓ ⁴	✓	✓	✓ ²
Material of heater	Graphite	Molybdenum	Tungsten	MoSi ₂
Material of insulation	Graphite felt	Molybdenum	Tungsten/Molybdenum	Ceramic fiber

¹Tmax reduces to 1400 °C

³Only with safety package for flammable gases

²Depending on the temperature

⁴Up to 1800 °C

Model	Inner dimensions of process box in mm			Volume in l
	w	d	h	
VHT 8/..	120	210	150	3,5
VHT 25/..	200	350	200	14,0
VHT 40/..	250	430	250	25,0
VHT 70/..	325	475	325	50,0
VHT 100/..	425	500	425	90,0
VHT 250/..	575	700	575	230,0
VHT 500/..	725	850	725	445,0

Model	Inner dimensions in mm			Volume in l	Max. charge weight/kg	Outer dimensions in mm			Heating power in kW ⁴			
	w	d	h			W	D	H	Graphite	Molybdenum	Tungsten	Ceramic fiber
VHT 8/..	170	240	200	8	5	1250 (800) ¹	1100	2700 ⁵	27/27 ⁻²	19/34 ³	50	12
VHT 25/..	250	400	250	25	20	1500	2500	2200	70/90 ⁻²	45/65 ³	85	25
VHT 40/..	300	450	300	40	30	1600	2600 ⁵	2300	83/103/125 ²	54/90 ³	110	30
VHT 70/..	375	500	375	70	50	1800 ⁵	3300 ⁵	2400	105/125/150 ²	70/110 ³	130	55
VHT 100/..	450	550	450	100	75	1900	3500 ⁵	2500	131/155/175 ²	90/140 ³	on request	85
VHT 250/..	600	750	600	250	175	3000 ¹	4300	3100	180/210 ⁻²	on request	on request	on request
VHT 500/..	750	900	750	500	350	3200 ¹	4500	3300	220/260 ⁻²	on request	on request	on request

¹With separated switching system unit

²1800 °C/2200 °C

³1200 °C/1600 °C

⁴Depending on furnace design connected load might be higher

⁵Dimensions may be smaller depending on the heater type



Retort furnace VHT 100/15-KE H₂ with fiber insulation and extension package for operation under hydrogen, 1400 °C



Retort furnace VHT 40/16-MO H₂ with hydrogen extension package and process box

H₂ Version for Operation with Hydrogen or other Reaction Gases

In the H₂ version the retort furnaces can be operated under hydrogen or other reaction gases. For these applications, the systems are additionally equipped with the required safety technology. Only certified and industry proven safety sensors are used. The retort furnaces are controlled by a fail-safe PLC control system (S7-300F/safety controller).

- Certified safety concept
- Automation package (additional equipment see page 28)
- Redundant gas inlet valves for hydrogen
- Monitored pre-pressures of all process gases
- Bypass for safe purging of furnace chamber with inert gas
- Pressure-monitored emergency flooding with automated solenoid valve opening
- Electric or gas-heated exhaust gas torch for H₂ post-combustion
- Atmospheric operation: H₂-purging of retort starting from room temperature at controlled over pressure (50 mbar relative)

Additional equipment

- Partial pressure operation: H₂ flushing at underpressure in the retort starting from 750 °C furnace chamber temperature
- Inner process hood in the retort for debinding under hydrogen
- Process control and documentation via Nabertherm Control Center (NCC) for monitoring, documentation and control see page 88



Gas management system

Bottom Loading Retort Furnace up to 2400 °C



Retort furnace LBVHT 250/20-W with tungsten heating chamber

The LBVHT model series with bottom loading specification are especially suitable for production processes which require either protective or reaction gase atmosphere or a vacuum. The basic performance specifications of these models are similar to the VHT models. Their size and design with electro-hydraulically driven table facilitate charging during production. The retort furnaces are available in various sizes and designs. Similar like the VHT models, these furnaces can be equipped with different heating concepts.

- Standard furnace sizes between 100 and 600 liters
- Designed as bottom loading retort furnace with electro-hydraulically driven table for easy and well-arranged charging
- Prepared to carry heavy charge weights
- Different heating concepts using
 - Graphite heating chamber up to Tmax 2400 °C
 - Molybdenum heating chamber up to Tmax 1600 °C
 - Tungsten heating chamber up to Tmax 2000 °C
- Frame structure filled with textured stainless steel sheets
- Standard design with gassing system for non-flammable protective or reaction gases
- Automatic gas supply system which also allows for operation with several process gases as additional equipment
- Gas supply systems for operating with hydrogen or other combustible reaction gases incl. safety package as additional equipment
- Switchgear and control box as well as gassing system integrated into the furnace housing
- Further product characteristics of the standard furnace as well as possible additional equipment can be found in the description of the VHT furnaces from Page 26

Model	Tmax °C	Model	Tmax °C	Model	Tmax °C	Inner dimensions in mm		Volume in l	Electrical connection*
						Ø	h		
LBVHT 100/16-MO	1600	LBVHT 100/20-W	2000	LBVHT 100/24-GR	2400	450	700	100	3-phase
LBVHT 250/16-MO	1600	LBVHT 250/20-W	2000	LBVHT 250/24-GR	2400	600	900	250	3-phase
LBVHT 600/16-MO	1600	LBVHT 600/20-W	2000	LBVHT 600/24-GR	2400	800	1200	600	3-phase

*Please see page 89 for more information about supply voltage



Retort furnace LBVHT 600/24-GR



Retort furnace LBVHT with graphite heating chamber

Cold-Wall Retort Furnaces up to 2400 °C or up to 3000 °C



Retort furnace SVHT 9/24-W with tungsten heating

Compared with the VHT models (page 26 ff), the retort furnaces of the SVHT product line offer improved performance data with regard to achievable vacuum and maximum temperature. Due to the design as pit-type furnace with tungsten heating, processes up to max. 2400 °C even in high vacuum can be implemented with retort furnaces of the SVHT.-W product line. Retort furnaces of the SVHT.-GR product line with graphite heating, also in pit-type design, can be operated in an inert gas atmosphere even up to max. 3000 °C.

- Standard sizes with a furnace chamber of 2 or 9 liters
- Designed as pit-type furnace, charged from above
- Frame construction with inserted sheets of textured stainless steel
- Dual shell water-cooled stainless steel container
- Manual operation of process gas and vacuum functions
- Manual gas supply for non-combustible process gas
- A step in front of the retort furnace for an ergonomic charging height
- Retort lid with gas-charged shock absorbers
- Controls and switchgear as well as gas supply integrated in furnace housing
- Defined application within the constraints of the operating instructions



Graphite heating module

- Further standard product characteristics see description for standard design of VHT models page 26

Heating Options

SVHT ..-GR

- Applicable for processes:
 - Under protective or reaction gases or in the vacuum up to 2200 °C under consideration of relevant max. temperature limits
 - Under inert gas argon up to 3000 °C
- Max. vacuum up to 10^{-4} mbar depending on the type of pump used
- Heating: graphite heating elements in cylindrical arrangement
- Insulation: graphite felt insulation
- Temperature measurement by means of an optical pyrometer



Cylindrical retort with tungsten heating

SVHT ..-W

- Applicable for processes under protective or reaction gases or in vacuum up to 2400 °C
- Max. vacuum up to 10^{-5} mbar depending on the type of pump used
- Heating: cylindrical tungsten heating module
- Insulation: tungsten and molybdenum radiant plates
- Optical temperature measurement with pyrometer



Cooling water distribution

Additional equipment such as automatic process gas control or design for the operation with flammable gases incl. safety system see VHT models page 26.

Model	Tmax °C	Work space dimensions Ø x h in mm	Useful volume in l	Outer dimensions in mm			Heating power in KW ¹	Electrical connection*
				W	D	H		
SVHT 2/24-W	2400	150 x 150	2,5	1300	2500	2000	55	3-phase
SVHT 9/24-W	2400	230 x 230	9,5	1400	2900	2100	95	3-phase
SVHT 2/30-GR	3000	150 x 150	2,5	1400	2750	2100	65	3-phase
SVHT 9/30-GR	3000	230 x 230	9,5	1500	2900	2100	90	3-phase

¹Depending on furnace design connected load might be higher

*Please see page 89 for more information about supply voltage

Retort Furnace Cooling Systems

Indirect cooling (hot-wall retort furnaces)

- Ambient air is blown onto the outer retorte surface to cool it down. The waste heat is removed via the exhaust air outlet of the furnace.
- The charge is cooled indirectly, which means that the atmosphere in the retort is not affected by the cooling
- The charge cannot be quenched with the cooling system

Direct cooling (cold-wall and hot-wall retort furnaces)

- Rapid gas cooling in the retort. For this purpose, the furnace atmosphere is circulated through a heat exchanger.
- The system pressure is not increased by the cooling; there is no gas quenching at high pressure
- Not available for processes with flammable furnace atmospheres

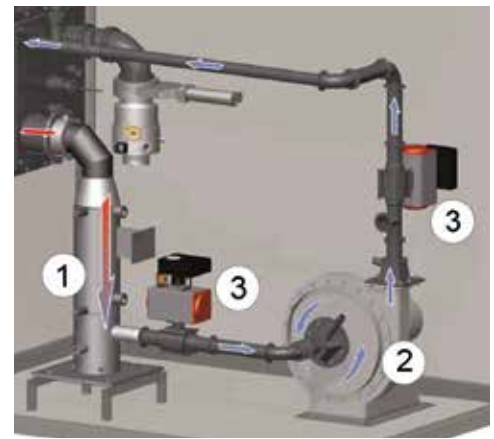

Schematic presentation of rapid gas cooling

- 1 Gas heat exchanger
- 2 Radial fan
- 3 Shut-off valves

Cooling Behavior of Hot-Wall Retort Furnace with Charge (Example)

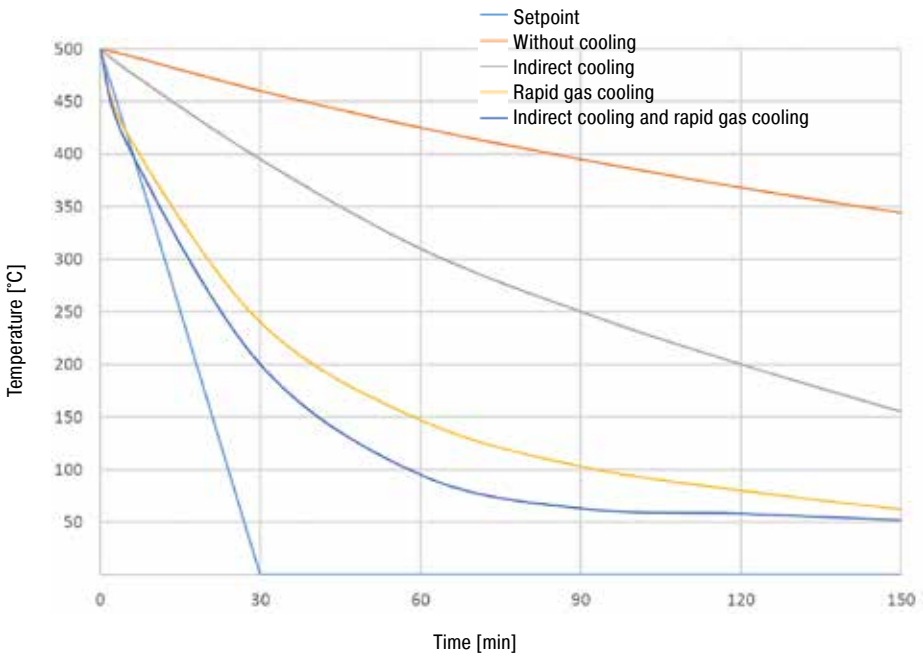

Fan cooling, hot-wall retort furnace NRA 400/03

Cooling Behavior of Cold-Wall Retort Furnace with Charge (Example)

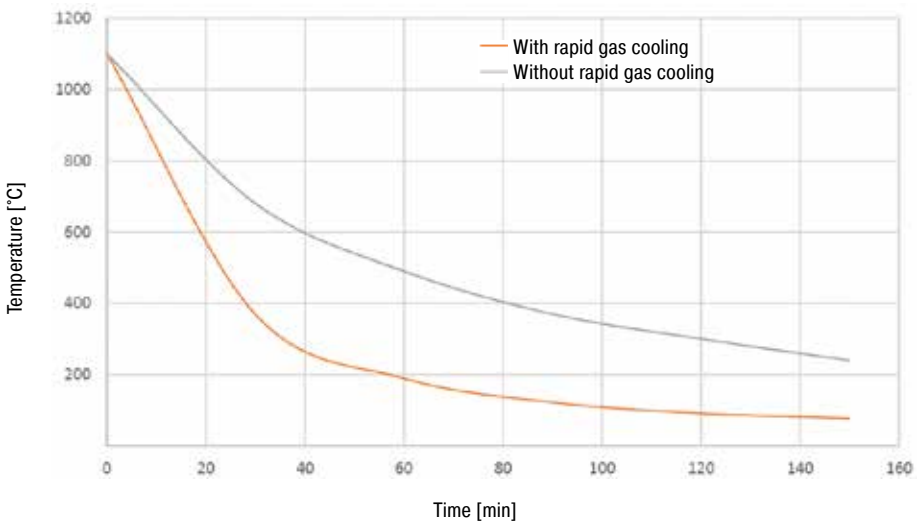

Rapid gas cooling, cold-wall retort furnace VHT 8/16-MO

Tube Furnaces for Processes under Flammable or Non-Flammable Protective or Reaction Gases or under Vacuum



Compact laboratory tube furnace with manual gas supply system



High-temperature tube furnace for four different protective gases

With the wide range of available accessories, our professional tube furnaces can be designed optimally to suit various processes. By upgrading with different gas supply systems, processes can be carried out in a protective gas atmosphere, in vacuum, or under flammable protective or reaction gases. In addition to the convenient standard controllers, modern PLC controls can be used also.

- Tube furnaces (static) with Tmax 1100 °C to 1800 °C (max. 1400 °C in vacuum) for horizontal or vertical operation
- Rotary tube furnaces for batch or continuous processes with Tmax 1100 °C or 1300 °C
- Different working tube materials designed for various process requirements
- Defined application within the constraints of the operating instructions
- NTLog Basic for Nabertherm controller: recording process data with a USB flash drive

Additional equipment

- Different gas supply system packages for flammable or non-flammable protective or reaction gases
- Vacuum operation
- Multiple zone design to optimize temperature uniformity
- Charge control with temperature measurement in the working tube and in the furnace chamber outside the tube
- Display of temperature in the working tube with additional thermocouple
- Cooling systems for accelerated cooling of the working tube and the charge
- Individual solutions for process optimization available



Vertical tube furnace RHTV 50/150/17 with stand and gas supply system 2 as additional equipment

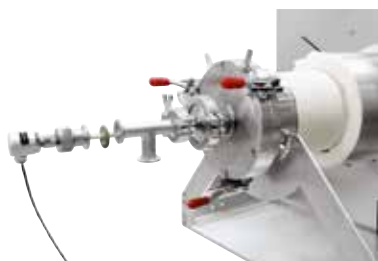

Thermocouple for charge control in the furnace RHTH 120/600/18

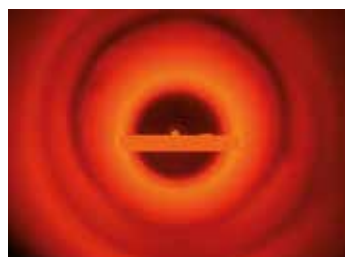

Sintering under hydrogen in a tube furnace of RHTH product line



Rotary Tube Furnace RSR 250/3500/15S

Customized Tube Furnaces



Tube furnace RS 200/4500/08 with lift door for heat treatment of bars

With their high level of flexibility and innovation, Nabertherm offers the optimal solution for customer-specific applications.

Based on our standard models, we develop individual solutions also for integration in overriding process systems. The solutions shown on this page are just a few examples of what is feasible. From working under vacuum or protective gas via innovative control and automation technology for a wide selection of temperatures, sizes, lengths and other properties of tube furnace systems – we will find the appropriate solution for a suitable process optimization.



Tube furnace RHTV 120/480/16 LBS with working tube closed at one side, protective gas and vacuum option as well as with electric screw drive of the lift table



RS 100/250/11S in split-type design for integration into a test stand



RS 250/2500/11S, five-zone controlled, for wire annealing in high-vacuum or under protective gases, incl. forced cooling and exhaust hood

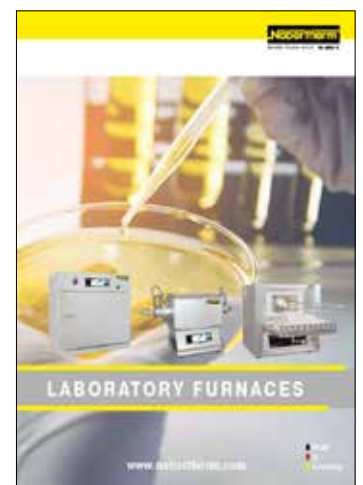

Please ask for our laboratory catalog to get further information about our extensive range of tube furnaces and other laboratory furnaces!

Wire and Strand Annealing Furnaces



D 250/S in production

Strand annealing furnace D 390/S

These models are particularly suitable for continuous heat treatment at operation temperatures up to 1200 °C. The modular design allows adjustment to different length and width requirements. The heating elements are mounted on only one side of the furnace and can be changed individually during operation. Optimum temperature uniformity is achieved by means of a multiple zone control system tailored to the furnace dimensions.

- Tmax 1200 °C
- Modular design, variable length
- Small outer dimensions due to efficient microporous silica insulation
- Special heating elements that can be changed during operation
- Heating from the ceiling
- Optimum temperature uniformity by means of multiple zone control
- Defined application within the constraints of the operating instructions
- Controls description see page 88

Additional equipment

- Gas supply systems for the working tubes for non-flammable or flammable protective or reaction gases including hydrogen, with burn off torch and safety technology
- Process and charge documentation
- Double chamber furnace system with parallel chambers for simultaneous operation at different temperatures
- Process control and documentation via VCD software package or Nabertherm Control Center (NCC) for monitoring, documentation and control see page 88



Wire annealing furnace based on a tube furnace with safety package for hydrogen as process gas



Strand annealing furnaces based on a tube furnace with a length of 6 meters

Model	Tmax °C	Inner dimensions in mm			Volume in l	Outer dimensions in mm			Heating power in kW ¹	Electrical connection*
		w	d	h		W	D	H		
D 20/S	1200	400	1000	50	20	900	1200	1350	9	3-phase
D 30/S	1200	600	1000	50	30	1100	1200	1350	12	3-phase
D 50/S	1200	200	3600	50	50	700	4000	1150	15	3-phase
D 60/S	1200	200	5600	50	60	700	6000	1350	36	3-phase
D 70/S	1200	350	3600	50	70	850	4000	1100	36	3-phase
D 110/S	1200	480	4600	50	110	980	5000	1450	36	3-phase
D 130/S	1200	650	3600	50	130	1150	4000	1150	60	3-phase
D 180/S	1200	480	7600	50	180	980	8000	1350	80	3-phase
D 250/S	1200	950	5600	50	250	1400	6000	1350	80	3-phase
D 320/S	1200	850	7600	100	320	1400	8000	1350	160	3-phase

¹Depending on furnace design connected load might be higher

*Please see page 89 for more information about supply voltage

Continuous Plants for Protective or Reaction Gas Atmospheres



Manual pusher-type furnace with cooling tunnel for hydrogen up to 1250 °C

Continuously operating furnaces are ideal for heat treatment of large numbers of small parts in a protective or reaction gas atmosphere, such as brazing, hardening, or annealing.

Controlled protective gas atmospheres are generated in the furnace by using a gas tight retort. If hydrogen or cracked gas is used for the process, the furnace is equipped with the corresponding safety technology.

Parameters such as maximum working temperature, exposure, and geometry of the charge all play a role in the choice of the conveying system. Established conveyor concepts include metal belts or rollers. Wire and strand annealing furnaces are used to anneal wires or strands; in this case, the charge is unwound in front of the furnace, drawn through the furnace and is then wound again behind the furnace.

To cool the components faster, a water-cooled dual shell is installed directly behind the heating zone; the length of this is determined by the required unloading temperature.



Metal conveyor belt, alternatively available as a roller conveyor

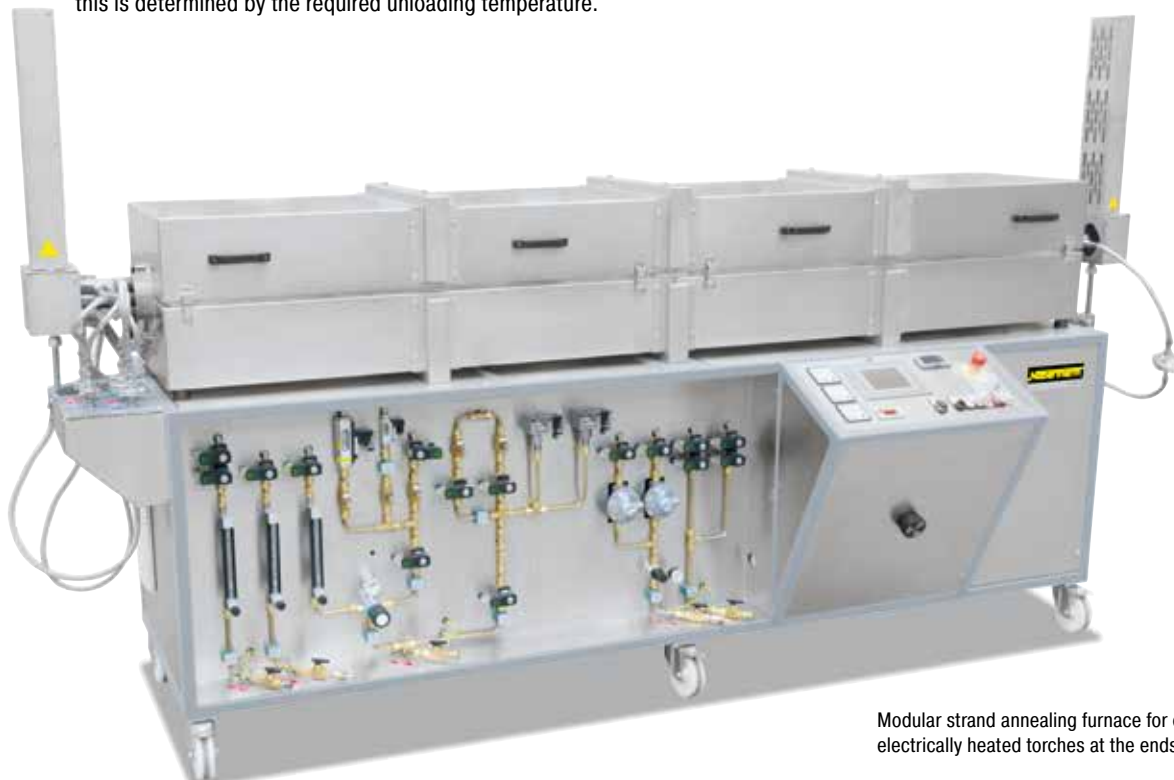

Modular strand annealing furnace for operation in a hydrogen atmosphere with electrically heated torches at the ends

Salt-Bath Furnaces for Heat Treatment of Steel or Light Metals

Electrically Heated or Gas-Fired



Salt-bath furnace TSB 30/30, gas-fired



Salt-bath furnace TS 30/30, electrically heated

Salt-bath furnaces have an excellent temperature uniformity and ensure very good heat transfer to the work piece. Generally, heat treatment can be carried out with shorter dwell times than in chamber furnaces. Since the charge is heat treated with the exclusion of oxygen, scale and discoloration on the surface of the parts are kept to a minimum.

The salt-bath furnaces TS 20/15 - TSB 90/80 can be used for heat treatment of metals in neutral and active salt baths. They are used for processes such as nitriding according to Tenifer up to 600 °C, carburization to 950 °C or bright annealing to 1000 °C.

The crucible is inserted so that it is suspended in the salt-bath furnace and can be replaced easily if necessary. Two crucible types are available:

- Type P: low carbon steel and CrNi plated for carburizing, neutral salt and annealing baths up to 850 °C
- Type C: high alloy CrNi steel for neutral salt and annealing baths up to 1000 °C

Crucibles are wearing parts because they are exposed to thermal stress during the heating and cooling process and corrosive salt. The following parameters influence wear of the crucible:

- Working temperature
- Number of heating and cooling cycles
- Salt
- Charge material
- Charge quantity
- Contamination of the charge

The crucible must be checked regularly for wear and damage. We recommend to order a replacement crucible together with the furnace.

Salt-bath furnaces are available for heat treatment of steel and aluminum:

Features for heat treatment of steel:

- Tmax in salt: 750 °C or 1000 °C
- Safety technology according to EN 60519-2
- Melt-bath control: the temperature is measured in the salt as well as inside the furnace behind the crucible
- Removable collar plate made of steel
- Insulated swing-away lid
- Temperature uniformity up to +/- 2 °C according to DIN 17052-1 in the salt bath see page 84
- Over-temperature limiter in the furnace chamber to protect persons and the furnace
- Crucible can be easily replaced
- Defined application within the constraints of the operating instructions
- Controls description see page 88

Features for heat treatment of aluminum like steel, but

- Tmax in salt: 550 °C
- Over-temperature limiter in the furnace chamber and in the salt bath to protect persons and the furnace
- Optical and acoustic alarm to warn if the critical temperature is exceeded
- Eurotherm 6100e temperature recorder to document the temperature profile

Salt-bath furnaces can be delivered electrically heated or gas-fired

- Electrically heated (TS models):
 - Freely radiating, high quality heating elements on ceramic support tubes
 - Crucible heated from four sides
 - If a heating element is defective, the furnace can be heated with the remaining heating elements
- Gas-fired (TSB models):
 - Burner system with optimized flame management: high level of efficiency with overpressure operation to prevent false air entering
 - Burner technology according to DIN EN 7462, part 2
 - Lateral exhaust gas feed around the crucible

Model	Tmax °C ²	Inner dimensions salt-bath crucible		Volume in l	Outer dimensions in mm			Heating power in kW ¹	Electrical connection*	Weight in kg
		Ø in mm	h in mm		W	D	H			
TS 20/15	750 ³	230	500	20	850	850	800	16	3-phase	650
TS 30/18	750 ³	300	500	30	950	950	800	20	3-phase	700
TS 40/30	750 ³	400	500	60	1050	1050	800	33	3-phase	750
TS 50/48	750 ³	500	600	110	1150	1150	970	58	3-phase	1000
TS 60/63	750 ³	610	800	220	1250	1250	970	70	3-phase	1200
TS 70/72	750 ³	700	1000	370	1350	1350	1370	80	3-phase	1500
TS 90/80	750 ³	900	1000	500	1600	1600	1400	100	3-phase	1700
TS, TSB 20/20	1000	230	500	20	850	850	800	21	3-phase	650
TS, TSB 30/30	1000	300	500	30	950	950	800	33	3-phase	700
TS, TSB 40/40	1000	400	500	60	1050	1050	800	44	3-phase	750
TS, TSB 50/60	1000	500	600	110	1150	1150	970	66	3-phase	1000
TS, TSB 60/72	1000	610	800	220	1250	1250	970	80	3-phase	1200
TS, TSB 70/90	1000	700	1000	370	1350	1350	1370	100	3-phase	1500
TS, TSB 90/80	1000	900	1000	500	1600	1600	1400	120	3-phase	1700

¹Depending on furnace design connected load might be higher

²Salt bath temperature

³Tmax for heat treatment of aluminum 550 °C

*Please see page 89 for more information about supply voltage



Salt-bath furnace TS 30/18 with preheating chamber above the salt bath and charging aid for immersion of the charge



Salt-bath furnace TS 90/80 with a salt bath thermocouple for heat treatment of steel

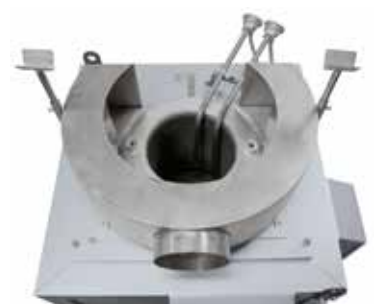

Salt-bath furnace TS 30/18 with two salt bath thermocouples for heat treatment of aluminum

Salt-Bath Furnaces for Heat Treatment of Steel or Light Metals

Electrically Heated or Gas-Fired



Salt-bath furnace TS 40/30 with exhaust gas collection at crucible rim and manual lid



Salt-bath furnace TS 40/30 with pneumatic lid opening

Accessories

- Exhaust gas collection at crucible rim
 - For the direct extraction of vapors and exhaust gases
 - Flange on the back to connect the customer's exhaust gas system
 - Only in combination with a lid that is manually placed on top
- Pneumatic lid opening
 - Pneumatic lateral movement of the swivel lid
 - Manual lowering and raising of the lid with a lever
 - Foot pedal control
 - Not available in combination with exhaust gas collection at crucible rim
- Charging basket for bulk materials
 - Possible lid closing over the salt bath with inserted charging basket
 - For manual charging of small martempering and salt baths
 - Charging with a crane or charging aid for large martempering and salt baths

- Process control and documentation via Nabertherm Control Center NCC for monitoring, documentation, and control

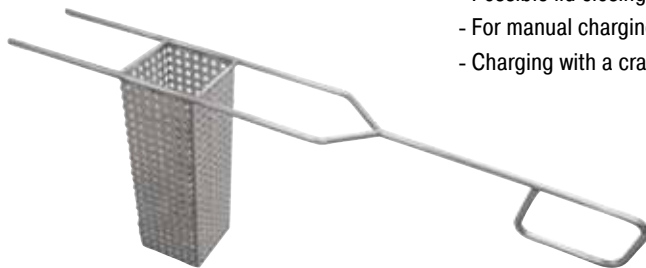

Charging basket for salt-bath furnaces

Process Examples with Petrofer and Durferri Salts

TS models up to 750 °C	
Nitriding	Nitrogen 420, Nitrogen 460, Nitrogen 500
Annealing and blackening	SFS 240
Hardening, Tempering, Annealing, Quenching	GS 185, GS 230, GS 250, GS 345, GS 405, GS 406, GS 430, GS 520
Preheating, annealing of gold, silver or brass	GS 560, HS 545
TS models up to 1000 °C	
Carbonitriding, carburizing	Carbogen VC, Carbogen OK
Annealing, hardening, preheating	HS 535, HS 545, HS 535, GS 560, GS 660
Carburizing	Carbogen Universal, Carborapid + GS-ZS, Carbomax +GS-ZS, Carbogen 800/800 ST, Carbogen 1000/ 1000 ST, CECONTROL 50H, CECONTROL 80B, CECONTROL 110B, CECONSTANT 80, CECONSTANT 100
Preheating of high-speed steel, annealing	GS 540, GS 660, GS 670, GS 750, HS 550, HS 635, HS 760
Preheating, annealing of gold, silver or brass	GS 560, HS 545
TS models for aluminum	
Artificial ageing, solution annealing	AS 135, AS 200, AS 225, AVS 220, AVS 250

Martempering Furnaces using Neutral Salts Electrically Heated

QS 20 - QS 400 martempering furnaces are filled with neutral salt and offer remarkably rapid and intensive heat transmission to the workpiece while ensuring optimum temperature uniformity. Since the batch is heat treated with the exclusion of oxygen, scale and discoloration on the surface of the parts are reduced to a minimum. For working temperatures at between 180 °C and 500 °C these martempering furnaces are useful for quenching or cooling with minimal workpiece distortion, retempering, austempering for optimal toughness, recrystallization annealing after electrical discharge machining (EDM) and for blueing.

The quenching or cooling process is applied in order to achieve an even temperature uniformity throughout the workpiece's entire cross-section before the formation of martensite and to avoid distortion and formation of cracks in complex mechanical components during the subsequent hardening process.

Tempering in a martempering bath is the same as the tempering process in forced convection furnace and is used to reduce a previously hardened workpiece to a desired hardness, to increase toughness and reduce stress within the workpiece.

Austempering is a good choice to achieve a high level of toughness and dimensional accuracy in oil hardened low-alloy steels. Workpieces subject to austempering have high tensile strength and good elasticity.

- Tmax 550 °C
- Very good temperature uniformity
- Martemper bath temperature control
- Over-temperature limiter with adjustable cutout temperature for thermal protection class 2 in accordance with EN 60519-2 as temperature limiter to protect the furnace and load
- Heating with immersion heating elements
- Rectangular crucible, integrated in the housing
- Charging basket
- Crucible made of 1.4828
- Defined application within the constraints of the operating instructions
- NTLog Basic for Nabertherm controller: recording of process data with USB-flash drive
- Controls description see page 88

Additional equipment

- Charging aid with hand crank and cable winch, mounted on side of furnace
- Process control and documentation via VCD software package for monitoring, documentation and control

Process Examples with Petrofer and Durferrit Salts

QS-baths (steel/Nitinol)	
Hardening, isothermic treatment of steels up to 950 °C, stress relieving, annealing, blueing, bainitization	AS 135, AS 140, AS 220, AS 225, AS 200, AS 235, GS 230
Homogenization annealing, recrystallization annealing, warm-bath curing, tempering, banitizing, blueing	AS 300

Model	Tmax °C	Inner dimensions in mm			Volume in l	Outer dimensions in mm			Heating power in kW ¹	Electrical connection*	Weight in kg
		w	d	h		W	D	H			
QS 20	550	300	210	460	20	610	580	920	2.6	1-phase	110
QS 30	550	300	210	580	30	610	580	920	3.2	1-phase	140
QS 70	550	400	300	680	70	750	680	980	7.5	3-phase	240
QS 200	550	540	520	880	200	900	900	1200	18.0	3-phase	660
QS 400	550	730	720	980	400	1100	1100	1300	24.0	3-phase	1150

¹Depending on furnace design connected load might be higher

*Please see page 89 for more information about supply voltage



Martempering furnace QS 20 with charging basket



Martempering hardening in practice



Heating element in the crucible



Martempering furnace QS 30 with charging aid



Chamber Furnaces Electrically Heated



Chamber furnace N 41/H



Chamber furnace N 321 with charging stacker

These universal chamber furnaces with radiation heating have been specifically designed to withstand heavy-duty use in the tool shop. They are particularly useful for processes such as tool making or for hardening jobs, e.g. annealing, hardening and forging. With help of various accessories, these furnaces can be customized to your application requirements.

- Compact, robust design
- Deep furnace chamber with three-sides heating: from both side walls and bottom
- Heating elements on support tubes ensure free heat radiation and a long service life
- Bottom heating protected by heat conducting SiC tiles
- Stainless steel upper door jamb protects furnace structure when furnace is opened hot
- Base frame included in the delivery, N 7/H - N 17/HR designed as table-top model
- Exhaust opening in the side of the furnace, or on rear wall of chamber furnace in the N 31/H models and higher
- Temperature uniformity up to +/- 10 °C according to DIN 17052-1 see page 84
- Low energy consumption due to multi-layer insulation
- Gas spring dampers provide for easy door opening and closing
- Heat resistant zinc paint for protection of door and door frame (for model N 81 and larger)
- Defined application within the constraints of the operating instructions
- NTLog Basic for Nabertherm controller: recording of process data with USB-flash drive
- Controls description see page 88



Annealing furnace N 7/H, as table-top model

For additional features see separate catalog „Thermal Process Technology I“

Model	Tmax °C	Inner dimensions in mm			Volume in l	Outer dimensions in mm			Heating power in kW ³	Electrical connection*	Weight in kg
		w	d	h		W	D	H			
N 7/H ¹	1280	250	250	140	9	800	650	600	3.0	1-phase	60
N 11/H ¹	1280	250	350	140	11	800	750	600	3.5	1-phase	70
N 11/HR ¹	1280	250	350	140	11	800	750	600	5.5	3-phase ²	70
N 17/HR ¹	1280	250	500	140	17	800	900	600	6.4	3-phase ²	90
N 31/H	1280	350	350	250	30	1040	1100	1340	15.0	3-phase	210
N 41/H	1280	350	500	250	40	1040	1250	1340	15.0	3-phase	260
N 61/H	1280	350	750	250	60	1040	1500	1340	20.0	3-phase	400
N 87/H	1280	350	1000	250	87	1040	1750	1340	25.0	3-phase	480
N 81	1200	500	750	250	80	1140	1900	1790	20.0	3-phase	820
N 161	1200	550	750	400	160	1180	1930	1980	30.0	3-phase	910
N 321	1200	750	1100	400	320	1400	2270	2040	47.0	3-phase	1300
N 641	1200	1000	1300	500	640	1690	2670	2240	70.0	3-phase	2100
N 81/13	1300	500	750	250	80	1220	1960	1840	22.0	3-phase	900
N 161/13	1300	550	750	400	160	1260	1990	2030	35.0	3-phase	1000
N 321/13	1300	750	1100	400	320	1480	2330	2090	60.0	3-phase	1500
N 641/13	1300	1000	1300	500	640	1770	2730	2290	80.0	3-phase	2500

¹Table-top model

²Heating only between two phases

*Please see page 89 for more information about supply voltage

³Depending on furnace design connected load might be higher

Charging Plates for Models N 7/H - N 641/13

We recommend these accessories for applications up to 1100 °C to protect the furnace floor, especially if a charging cart is used.



Charging plate

- Tmax 1100 °C
- Three raised edges
- Heat-resistant alloy 314 (AISI)/(DIN material no. 1.4841)
- Larger plates and custom dimensions available upon request

Article no.	Furnace	Outer dimensions in mm		
		W	D	H
628000138	N 7/H	240	290	25
628000139	N 11/H, N 11/HR	240	390	25
628000141	N 17/HR	240	540	30
628000400	N 31/H	340	390	30
628000133	N 41/H	340	540	30
628000142	N 61/H	340	790	30
628001925	N 87/H	340	1040	30
628000143	N 81, N 81/13	480	790	30
628000144	N 161, N 161/13	530	790	30
628000145	N 321, N 321/13	720	1140	30
628000146	N 641, N 641/13	950	1330	30

Annealing Boxes for Models N 7/H - N 161/13



Annealing box with lid and granulate

Working with Annealing Boxes

Annealing boxes are made of heat-resistant alloy 314 (AISI)/(DIN material no. 1.4841) and also feature a lid for top charging. A ceramic fiber gasket is inserted in the circular seal profile on the upper edge of the box to seal it. To prevent oxidation during the process, neutral annealing coal is placed in the box. These bind the oxygen in the box. The oxygen inside the box is bound by the coal. After the heat treatment, the box is removed from the oven, the lid is opened using tongs and the workpiece removed. Our annealing boxes are also well suited for brazing.

The boxes can also be used with the appropriate granulate for carburizing (also referred to as case hardening or cementing) and for powder nitriding or powder boriding. The workpieces are placed in the box with carburizing granulate or nitriding powder or boriding powder and a suitable activator.

- Tmax 1100 °C
- Annealing box with lid and seal profile
- Lid sealing with ceramic fiber
- Also usable for carburizing and powder nitriding
- Heat-resistant alloy 314 (AISI)/(DIN material no. 1.4841)



Annealing box on stacker

Article no.	Furnace	Inner dimensions in mm			Outer dimensions in mm			Charging method of the box
		w	d	h	W	D	H	
631000962	N 7/H	180	190	90	216	226	116	charging fork
631000967	N 11/H, N 11/HR	180	290	90	216	326	116	charging fork
631000972	N 17/HR	180	440	90	216	476	116	charging fork
631000977	N 31/H	280	230	200	316	304	226	draw hook
631000982	N 41/H	280	380	200	316	454	226	draw hook
631000986	N 61/H, N 87/H	280	500	200	316	574	226	draw hook
631000138	N 81, N 81/13	394	494	185	462	530	210	charging cart
631000312	N 161, N 161/13	450	550	250	515	596	357	charging stacker

Article no. 601655055, 1 set of fiber insulation cord, 5 strips of 610 mm each

Work space = box inner dimensions: - 30 mm to all sides

Larger boxes and custom dimensions available upon request

Protective Gas Boxes for Models N 7/H - N 641/13

The annealing boxes for heat treatment under protective gas are equipped with a protective gas inlet and outlet. A box with protective gas is advisable for larger workpieces requiring defined heat treating. We would be pleased to carry out Trials at our technical center can be carried out on request. Up to furnace model N 61/H with downward door opening the gas ductway is laid through the upper section of the door collar, for larger furnaces with upward door opening the supply line is laid through the lower furnace collar.

The box is pressurized with non flammable protective and reactive gases such as argon, nitrogen or forming gas via the protective gas tube. There are manual and automatic systems available for protective gas. See pages 74 - 75. for more information about protective gases which can be used as well as manual and automatic protective gas systems.

After charging the box it is closed and preflushed outside the furnace. Afterwards the box is placed in the preheated furnace. The quantity of gas can be reduced to the process flush quantity. After the heat treatment the box is pulled out of the furnace, the charge taken from the box and placed in the quenching medium. We recommend using binding wire on the parts so that they can easily be grasped by tongs.

A flexible type K thermocouple is installed in the box for measuring the temperature; we recommend connecting it to a digital display device or to a temperature recorder.

The box can also be cooled down on a cooling platform while closed. Be sure that the protective gas flowrate is increased for this application.

- Tmax 1100 °C
- For non-combustible protective and reactive gases argon, nitrogen and forming gas (observe national regulations)
- Protective gas box with fiber sealing and lid, gas supply via a tube into the bottom of the box
- Protective gas connection via quick coupling with hose connector (inner diameter 9 mm)
- Piping for gas inlet and outlet through the furnace collar
- Heat-resistant alloy 314 (AISI)/(DIN material no. 1.4841)
- Charge thermocouple type K for temperature display or charge control

Additional equipment

- Starting from N 31/H a charging cart is recommended see page 78
- Digital temperature display see page 69
- Gas supply systems see page 74
- Charging forks see page 47
- Draw Hook see page 77



Box with protective gas connection



N 7/H



Winch stacker with protective gas box and furnace

Article no.	Furnace	Inner dimensions in mm			Outer dimensions in mm ¹			Preflush rate l/min	Process flush rate l/min	Charging method of the box
		w	d	h	W	D	H			
631000963	N 7/H	180	190	90	216	226	116	15 - 20	5 - 8	charging fork
631000968	N 11/H, N 11/HR	180	290	90	216	326	116	15 - 20	5 - 8	charging fork
631000973	N 17/HR	180	440	90	216	476	116	15 - 20	5 - 8	charging fork
631000978	N 31/H	280	230	200	316	304	226	20 - 25	10 - 15	draw hook
631000983	N 41/H	280	380	200	316	454	226	20 - 25	10 - 15	draw hook
631000987	N 61/H, N 87/H	280	500	200	316	574	226	20 - 25	10 - 15	draw hook
631000392	N 81, N 81/13	394	494	185	462	530	212	20 - 30	10 - 20	charging stacker
631000393	N 161, N 161/13	450	550	250	515	596	355	20 - 30	10 - 20	charging stacker
631000607	N 321, N 321/13	470	850	185	580	960	330	20 - 30	10 - 20	charging stacker
631000608	N 641, N 641/13	720	1050	270	830	1160	414	20 - 30	10 - 20	charging stacker

Article no. 601655055, 1 set of fiber insulation cord, 5 strips of 610 mm each

Work space = box inner dimensions: - 30 mm to all sides

Larger boxes and custom dimensions available upon request

¹ Without piping

Protective Gas Boxes with Evacuation Lid for Models N 7/H - N 614/13

For heat treatment of bulk goods and hollow parts under protective gas atmosphere we recommend the usage of protective gas boxes with an additional evacuation lid.

These boxes are equipped with a lid for top charging, protective gas inlet and outlet as well as a evacuation lid with rubber sealing gasket. Gas ductwork and handling while hot is the same as the protective gas boxes described on page 45. In addition, these

boxes also feature a connection for a vacuum pump with a shut-off valve.

After charging the box in a cold state it is evacuated and afterwards flushed with protective gas. By repeating this process once or several times the results are considerably improved. After the box was flushed with protective gas the last time, the evacuation lid is removed and the box is placed into the preheated furnace. Protective gas is used for heat treatment. Thus traces of oxygen in the box can be reduced by a considerable amount which improves the quality of the components accordingly.

After the heat treatment the box is taken out of the furnace and can be cooled in air or be opened to remove the charge.

Protective gas box for N 41/H furnace with additional evacuation lid

The box can also be force-cooled on a cooling platform while closed. Be sure that the protective gas flowrate is increased for this application.

- Tmax 1100 °C
- For non-combustible protective and reactive gases argon, nitrogen and forming gas (observe national regulations)
- Protective gas box with fiber sealing and lid with locks, recess for evacuation lid, gas inlet via a pipe into the bottom of the box
- Evacuation lid with rubber sealing (Elastomer) and manometer
- Protective gas connection via threeway ball valve and quick coupling with hose connector (inner diameter 9 mm)
- Piping for gas inlet and outlet through the furnace collar
- Heat-resistant alloy 314 (AISI)/(DIN material no. 1.4841)
- Charge thermocouple type K for temperature display or charge control

Additional equipment

- Starting from N 31/H a charging cart is recommended see page 78
- Digital temperature display see page 69
- Vacuum pump see page 75
- Gas supply systems see page 74
- Charging forks see page 47
- Draw Hook siehe Seite 77

Article no.	Furnace	Inner dimensions in mm			Outer dimensions in mm ¹			Preflush rate l/min	Process flush rate l/min	Charging method of the box
		w	d	h	W	D	H			
631000966	N 7/H	170	170	70	212	212	106	15 - 20	5 - 8	charging fork
631000971	N 11/H, N 11/HR	170	270	70	212	312	106	15 - 20	5 - 8	charging fork
631000976	N 17/HR	170	420	70	212	462	106	15 - 20	5 - 8	charging fork
631000981	N 31/H	250	200	150	292	242	178	20 - 25	10 - 15	draw hook
631000985	N 41/H	250	350	150	292	392	178	20 - 25	10 - 15	draw hook
631000989	N 61/H, N 87/H	250	500	150	292	542	178	20 - 25	10 - 15	draw hook
631000526	N 81, N 81/13	354	494	185	422	905	215	20 - 30	10 - 20	charging stacker
631000527	N 161, N 161/13	400	550	250	468	965	350	20 - 30	10 - 20	charging stacker
631006325	N 321, N 321/13	500	700	200	650	1150	340	20 - 30	10 - 20	charging stacker
631006326	N 641, N 641/13	700	900	250	850	1400	430	20 - 30	10 - 20	charging stacker

Article no. 601655055, 1 set of fiber insulation cord, 5 strips of 610 mm each
Work space = box inner dimensions: - 30 mm to all sides

¹ Without piping and evacuation lid

Larger boxes and custom dimensions available upon request

Charging Forks



- Charging forks to charge and remove protective gas boxes up to model N 17/H

Article no.	Furnace
631001016	N 7/H, N 11/H(R)
631001017	N 17/HR

Protective Gas Boxes with Hinged Lids for Fast Quenching for Models N 7/H - N 31/H

For heat treatment of small amounts of bulk material or small parts under protective gases with subsequent fast quenching in oil or water, we recommend to use protective gas boxes with a hinged lid. Boxes with an angled hinged lid on the front are equipped with a protective gas line on the rear wall. The supply line is run through the upper furnace collar.

After preflushing the box with non-flammable protective and reactive gases such as argon, nitrogen or forming gas 95/5, the box is placed with hinged lid first into the furnace. Due to a slight overpressure within the box the protective gas is vented off through the hinged lid.

After the heat treatment the box is taken out of the furnace and the charge is poured into quenching bath directly out of the box. By placing the box at an angle the hinged lid opens by itself. The contact with ambient air is reduced to a minimum.

- Tmax 1100 °C
- For non-combustible protective and reactive gases argon, nitrogen and forming gas (observe national regulations)
- Protective gas box with flap lid and gas supply from the rear wall
- Protective gas connection via quick coupling with hose connector (inner diameter 9 mm)
- Piping for gas inlet and outlet through the furnace collar
- Lid remains closed through its own weight
- Holder with hand handle
- Heat-resistant alloy 314 (AISI)/(DIN material no. 1.4841)
- Charge thermocouple type K for temperature display or charge control

Additional equipment

- Starting from N 31/H a charging cart is recommended see page 78
- Digital temperature display see page 69
- Gas supply systems see page 74



Protective gas box with hinged lid

Article no.	Furnace	Inner dimensions in mm			Outer dimensions in mm ¹			Preflush rate l/min	Process flush rate l/min
		w	d	h	W	D	H		
631000964	N 7/H	180	160	90	216	210	110	15 - 20	5 - 8
631000969	N 11/H, N 11/HR	180	260	90	216	310	110	15 - 20	5 - 8
631000974	N 17/HR	180	410	90	216	460	110	15 - 20	5 - 8
631000979	N 31/H	260	220	120	290	272	140	20 - 25	10 - 15

Work space = box inner dimensions: - 30 mm to all sides

Larger boxes and custom dimensions available upon request

¹ Without piping

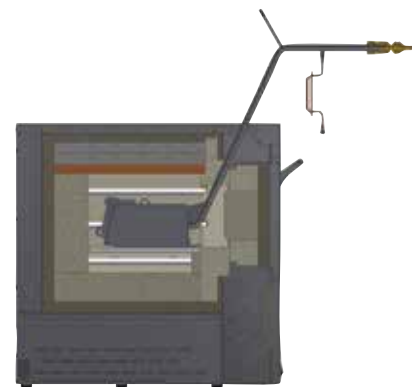

Gas Feed Boxes with Hinged Lid for Models N 7/H - N 87/H which Remain in the Furnace

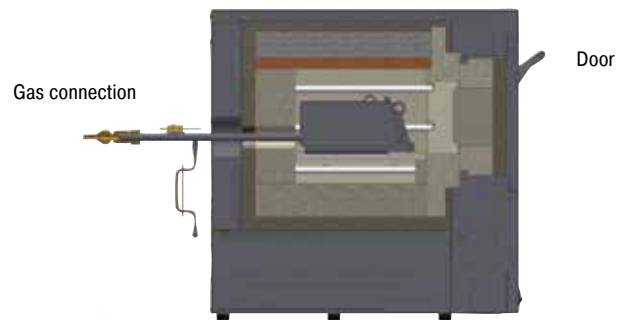

Protective gas box with hinged lid for permanent operation

Working with Protective Gas Boxes with Hinged Lid in continuous Operation

In the case of successive protective gas heat treatment of individual parts, a gassing box is recommended, which remains in the furnace. For charging, the box is equipped with a flap lid to the front. The lid closes without a sealing profile against the oblique position of the box opening. Larger gas losses in comparison with removable boxes can be expected. For the protective gas supply the pipe goes through a bore on the rear wall of the furnace.

For charging, the box is opened in the furnace using a draw hook and the workpieces are placed into the box. The box is continuously flushed with non-flammable protective and reactive gases such as argon, nitrogen or forming gas 95/5. Due to a slight overpressure within the box the protective gas is vented off through the hinged lid.

After the heat treatment the box is opened using a draw hook and the workpieces are removed.

- Tmax 1100 °C
- For non-combustible protective and reactive gases argon, nitrogen and forming gas (observe national regulations)
- Protective gas box with flap lid and gas supply from the rear wall
- Protective gas connection via quick coupling with hose connector (inner diameter 9 mm)
- Piping for gas inlet and outlet through the rear wall
- Front flap lid which opens downwards
- Heat-resistant alloy 314 (AISI)/(DIN material no. 1.4841)
- Charge thermocouple type K for temperature display or charge control
- The furnace will not be equipped with a charging plate (protective gas box is permanently installed)

Additional equipment

- Digital temperature display see page 69
- Gas supply systems see page 74

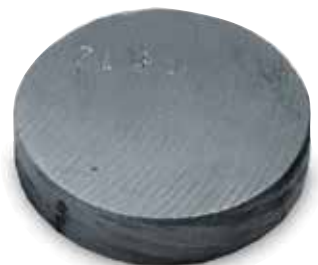

Probes heat treated in different processes

Article no.	Furnace	Inner dimensions in mm			Outer dimensions in mm ¹			Preflush rate l/min	Process flush rate l/min
		w	d	h	W	D	H		
631000965	N 7/H	170	170	80	213	221	114	15 - 20	5 - 8
631000970	N 11/H, N 11/HR	170	270	80	213	321	114	15 - 20	5 - 8
631000975	N 17/HR	170	420	80	213	471	114	15 - 20	5 - 8
631000980	N 31/H	270	260	190	303	321	224	20 - 25	10 - 15
631000984	N 41/H	270	410	190	303	471	224	20 - 25	10 - 15
631000988	N 61/H	270	660	190	303	721	224	20 - 25	10 - 15
631000990	N 87/H	270	910	190	303	971	224	20 - 25	10 - 15

Work space = box inner dimensions: - 30 mm to all sides

Larger boxes and custom dimensions available upon request

¹ Without piping

Protective Gas Annealing Bag and Holder for Models N 7/H - N 87/H

When workpieces made of air-hardened steel must be heat treated under protective gas and quenched afterwards, the protective gas annealing bag with holder is an optimal solution. This system consists of a holder with charge carrier and protective gas tube as well as a bag made of stainless steel heat treating foil.

The charge is placed on the charge carrier and covered with the protective gas annealing bag. The bag is preflushed with non-flammable protective and reactive gases such as argon, nitrogen or forming gas 95/5 and placed together with the holder in the furnace. After the charge has been heated, the protective gas annealing bag and holder are removed from the furnace and cooled with the help of the forced cooling system or in still air. At the same time the workpiece remains in the bag in the protective gas atmosphere. This prevents oxidation from occurring. Due to thin-walled foil very rapid cooling times can be achieved.

The protective gas annealing bag is also suitable for quenching workpieces in oil or water. The protective gas annealing bag with holder is taken out of the hot furnace after the heating time. The bag is pulled off the holder above the quenching bath using a heat protection glove. After this the workpiece can slide directly into the quenching bath. The short exposure to ambient air while being pulled out normally has only minimum effect on the surface oxidation of workpieces.

The bags can be used multiple times. Our experience shows that at temperatures < 950 °C the stainless steel heat treating bag lasts for approx. 10 - 15 processes. At temperatures between 950 °C and 1050 °C, use for approx. 5 - 10 processes can be assumed.

- Tmax 1100 °C
- For non-combustible protective and reactive gases argon, nitrogen and forming gas (observe national regulations)
- Holder with protective gas annealing bag
- Supplied with three protective gas annealing bags
- Protective gas supply with quick lock and hose connector (inner diameter 9 mm)
- Protective protective gas through notch in upper furnace collar
- Holder with hand handle
- Heat-resistant alloy 314 (AISI)/(DIN material no. 1.4841)
- Charge thermocouple type K for temperature display or charge control

Additional equipment

- Starting from N 31/H a charging cart is recommended see page 78
- Digital temperature display see page 69
- Gas supply systems see page 74



Protective gas annealing bag in operation



Thermocouple integrated in holder

Article no.	Furnace	Useable inner dimensions in mm			Replacement bag (article no.)	Bag dimensions in mm			Preflush rate l/min	Process flush rate l/min
		w	d	h		w	d	h		
631000539	N 7/H	60	180	30	491040825	60	180	30	15 - 20	5 - 8
631000540	N 11/H, N 11/HR	100	180	50	491042225	100	180	50	15 - 20	5 - 8
631000541	N 17/HR	100	280	50	491042235	100	280	50	15 - 20	5 - 8
631000542	N 31/H	100	180	50	491042225	100	180	50	15 - 20	5 - 8
631000543	N 41/H	140	350	60	491043640	140	350	60	15 - 20	5 - 8
631000544	N 61/H, N 87/H	180	350	70	491045242	180	350	70	20 - 25	10 - 15

Stainless Steel Heat Treating Foil to avoid Surface Reactions



Single parts requiring protection against decarburizing can be wrapped in a stainless steel heat treating foil off the roll or packed in prepared envelopes or bags. The rolls are available in various lengths and widths, the envelopes and bags are supplied in various dimensions.

Foil off the roll can be cut to size using gold plates scissors and the workpiece can be wrapped to requirements. See page 76 - 77 for more details about accessory supplies required, such as tongs and special gloves. The protected workpiece can now be loaded into the heated furnace. Due to the foil's thinness, it takes on the furnace temperature immediately and binds oxygen trapped in the foil packaging. There is then no oxygen present to oxidize the workpiece itself. The workpiece stays clean.

After the appropriate dwell time in the furnace, the wrapped workpiece is immersed in the quenching medium. After quenching the foil is removed and the part is then tempered.

Care should be taken to ensure that the foil is not too close to the workpiece as otherwise the foil may become damaged. If the workpiece should have several openings or gaps, and a large amount of oxygen can be wrapped up, these gaps can be filled in with foil pieces. This increases the foil surface area.

The foil has very sharp edges. Use gloves and tools.



Workpieces in foil heat treating

Annealing and Heat Treating Foils



Stainless steel heat treating foil

- Tmax 1200 °C
- Stainless steel heat treating foil for single use
- Ultra-thin stainless steel heat treating foil for bright annealing of workpieces in all shapes and sizes
- Foil is cut to the correct size
- Workpieces are packed into the foil as closely as possible
- Airtight lock by means of folds of a fold lock or suitable tools (see below)
- Rapid heating of the foil binds the oxygen in the packed piece, preventing virtually all oxidation and decarburizing
- Quenching takes place with a foil, so the workpiece remains protected
- Rapid quenching

Article no.	Dimensions	
	Width in mm	Length in m
491020615	610.0	7.5

Accessory Equipment for Processing Bags, Envelopes and Foils



Art.-Nr. 491047010, fold lock

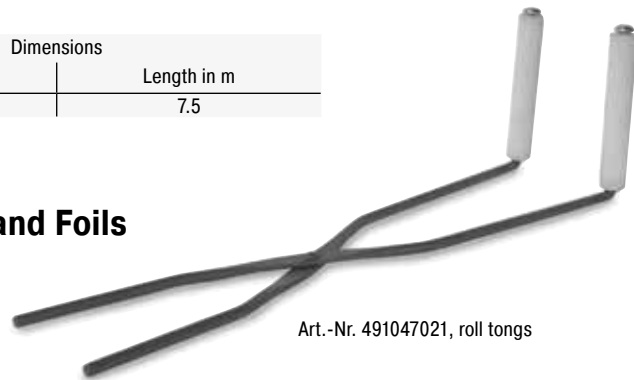

Art.-Nr. 491047021, roll tongs

We recommend using special protective gloves and tools for closing bags, envelopes and foils because the foil has very sharp edges and can be damaged if handled using conventional tools.

Article no.	Description
491047010	Fold lock with rotating handle
491047021	Roll tongs for annealing envelopes and bag
491041106	Hynit L finger protection gloves for foil use

Annealing Envelopes



- Annealing envelopes useful up to Tmax 1200 °C
- For hardening small parts
- Airtight lock by means of folds of a fold lock or suitable tools see page 50
- Rapid heating of the foil binds the oxygen in the annealing envelope preventing virtually all oxidation and decarburizing
- Rapid quenching in air, oil or water, ensuring high dimensional accuracy
- Workpieces are placed as tightly as possible in the annealing envelope
- Envelopes made of ultra-thin stainless steel heat treating foil, welded on three sides, for single use

Annealing envelopes

Article no.	Dimensions in mm	
	Width	Length
491001000	63	127
491001501	63	203
491002000	101	152
491002501	101	228
491002999	152	203
491003500	152	304

Article no.	Dimensions in mm	
	Width	Length
491004000	203	254
491004501	203	355
491005001	254	304
491005500	254	406
491006000	304	355
491006500	304	457

Other dimensions available upon request

Annealing Bags

- Annealing bag suitable for powder nitriding, boriding and high speed steel hardening up to approx. 1050 °C - 1150 °C for cold work purposes
- Made of stainless steel heat treating foil for single use
- For hardening of blocks, stamps, cutting plates, etc.
- Rapid heating binds the oxygen in the annealing bag so that high-alloy and medium-alloy steel grades can be hardened
- Rapid quenching in air, oil or water, ensuring high dimensional accuracy
- Workpieces are placed as tightly as possible into the annealing bag
- Airtight lock by means of folds of a fold lock or suitable tools see page 50



Annealing bags

Quadratic cross-section			
Article no.	Dimensions in mm		
	W	D	H
491063520	40	200	40
491063530	40	300	40
491064520	60	200	60
491064530	60	300	60
491065520	80	200	80
491065530	80	300	80
491066520	100	200	100
491066545	100	450	100

Rectangular cross-section			
Article no.	Dimensions in mm		
	W	D	H
491041520	100	200	25
491041530	100	300	25
491043030	150	300	25
491043520	150	200	40
491043550	150	500	40
491045030	200	300	40
491045242	200	420	100
491046535	250	350	40

Other dimensions available upon request

Carburizing Granulate



Carburizing granulate

- Workpieces are placed into an annealing box with carburizing granulate and the lid is closed and sealed
- At approx. 900 °C the steel reacts with the carbon and forms an approx. 0.2 - 2 mm thick layer
- The thickness of the layer depends on the length of the process, approx. 0.1 mm/hr, a process time of approx. 6 - 8 hrs achieves good average results
- Powder for alloyed and non-alloyed steels as well as granulate for multiple use with approx. 20 % new granulate added
- Supplied in 25 kg sacks

Article no.	Description
491070250	KG 6 - granulate for alloyed steels and multiple re-use
491070275	KG 30 - granulate for non-alloyed steels and multiple re-use

Nitriding Powder and Activator



Nitriding powder

- Workpieces are placed into an annealing box together with the nitriding powder and activator and the lid is closed and sealed
- Powder nitriding causes a thin cover layer to form against friction wear and fatigue resistance is substantially increased
- At approx. 550 °C an extremely thick cover layer forms (up to 1000 HV) which covers the hardened steel or the carburized edge layer. The activator improves process conditions.
- The process duration at 550 °C is at least 10 hrs
- For all steels and cast iron, such as hot work steel matrices, injection molding dies, wear parts and machine components
- Anti-nitriding paste to protect areas which should not be processed

Article no.	Description	Container
491010250	Nitriding powder	100 kg
491010150	Activator	35 kg
491010100	Activator	5 kg
491003000	Anti-nitriding paste	2 kg

Process Examples



Permanently installed protective gas box which is loaded from the front



Heat treatment under protective gas atmosphere in a protective gas box incl. charge thermocouple



Protective gas box used in a large bogie hearth furnace with air circulation



Protective gas box with flap which opens together with the furnace door



Hardening in annealing tray with alloy bag



Bulk material bright annealing in an annealing box with evacuation facility

Chamber Furnaces with Brick Insulation or Fiber Insulation



Chamber furnace LH 30/14



LH 60/12 with manual lift door and protective gas box for non-flammable protective or reactive gases

The chamber furnaces LH 15/12 - LF 120/14 have been trusted for many years as professional chamber furnaces. These furnaces are available with either a robust insulation of light refractory bricks (LH models) or with a combination insulation of refractory bricks in the corners and low heat storage, quickly cooling fiber material (LF models). With a wide variety of optional equipment, these chamber furnaces can be optimally adapted to your processes.



Cooling fan in combination with motor-driven exhaust air flap to reduce cooling time

- Tmax 1200 °C, 1300 °C, or 1400 °C
- Dual shell housing with rear ventilation, provides for low shell temperatures
- High furnace chamber with five-sided heating for very good temperature uniformity
- Heating elements on support tubes ensure free heat radiation and a long service life
- Controller mounted on furnace door and removable for comfortable operation
- Protection of bottom heating and flat stacking surface provided by embedded SiC plate in the floor
- LH models: multi-layered insulation of light refractory bricks and special backup insulation
- LF models: high-quality fiber insulation with corner bricks for shorter heating and cooling times. Only fiber materials are used which are not classified as carcinogenic according to TRGS 905, class 1 or 2.
- Door with brick-on-brick seal, hand fitted
- Short heating times due to high installed power
- Self-supporting arch for high stability and greatest possible protection against dust
- Quick lock on door
- Motor driven exhaust air flap
- Freely adjustable air slide intake in furnace floor
- Base included
- Defined application within the constraints of the operating instructions
- NTLog Basic for Nabertherm controller: recording of process data with USB-flash drive
- Controls description see page 88

Additional equipment

- Parallel swinging door, pivots away from operator, for opening when hot
- Lift door with electro-mechanic linear drive
- Separate wall-mounting or floor standing cabinet for switchgear



Gas supply system for non-flammable protective or reaction gases



Chamber furnace LH 216/12SW with scale to measure weight reduction during annealing



Chamber furnace LH 30/12 with manual lift door

- Cooling fan for shorter cycle times
- Protective gas connection to purge with non-flammable protective or reaction gases
- Manual or automatic gas supply system
- Scale to measure weight reduction during annealing
- Process control and documentation via VCD software package or Nabertherm Control Center (NCC) for monitoring, documentation and control see page 88

Model	Tmax °C	Inner dimensions in mm			Volume in l	Outer dimensions in mm			Heating power in kW ²	Electrical connection*	Weight in kg
		w	d	h		W	D	H			
LH 15/12	1200	250	250	250	15	680	860	1230	5.0	3-phase ¹	170
LH 30/12	1200	320	320	320	30	710	930	1290	7.0	3-phase ¹	200
LH 60/12	1200	400	400	400	60	790	1080	1370	8.0	3-phase	300
LH 120/12	1200	500	500	500	120	890	1180	1470	12.0	3-phase	410
LH 216/12	1200	600	600	600	216	990	1280	1590	20.0	3-phase	450
LH 15/13	1300	250	250	250	15	680	860	1230	7.0	3-phase ¹	170
LH 30/13	1300	320	320	320	30	710	930	1290	8.0	3-phase ¹	200
LH 60/13	1300	400	400	400	60	790	1080	1370	11.0	3-phase	300
LH 120/13	1300	500	500	500	120	890	1180	1470	15.0	3-phase	410
LH 216/13	1300	600	600	600	216	990	1280	1590	22.0	3-phase	460
LH 15/14	1400	250	250	250	15	680	860	1230	8.0	3-phase ¹	170
LH 30/14	1400	320	320	320	30	710	930	1290	10.0	3-phase ¹	200
LH 60/14	1400	400	400	400	60	790	1080	1370	12.0	3-phase	300
LH 120/14	1400	500	500	500	120	890	1180	1470	18.0	3-phase	410
LH 216/14	1400	600	600	600	216	990	1280	1590	26.0	3-phase	470
LF 15/13	1300	250	250	250	15	680	860	1230	7.0	3-phase ¹	150
LF 30/13	1300	320	320	320	30	710	930	1290	8.0	3-phase ¹	180
LF 60/13	1300	400	400	400	60	790	1080	1370	11.0	3-phase	270
LF 120/13	1300	500	500	500	120	890	1180	1470	15.0	3-phase	370
LF 15/14	1400	250	250	250	15	680	860	1230	8.0	3-phase ¹	150
LF 30/14	1400	320	320	320	30	710	930	1290	10.0	3-phase ¹	180
LF 60/14	1400	400	400	400	60	790	1080	1370	12.0	3-phase	270
LF 120/14	1400	500	500	500	120	890	1180	1470	18.0	3-phase	370

¹Heating only between two phases

*Please see page 89 for more information about supply voltage

²Depending on furnace design connected load might be higher



Parallel swinging door for opening when hot

Protective Gas Boxes for Models LH 15/.. - LH 216/..

Due to the cubic interior of the LH chamber furnaces and the corresponding protective gas boxes, these furnaces are ideally suited for higher batches. Gassing boxes for the LH models have a standard charge thermocouple, which can be used, for example, for charge control. The protective gas inlet and outlet is routed through the furnace collar in the case of a furnace with a swivel door on the left and through the lower furnace collar in the lift-door configuration.

These boxes have a lid for charging from above, protective gas inlet and outlet.



Protective gas box for furnaces with hinged door

- Tmax 1100 °C
- For non-combustible protective and reactive gases argon, nitrogen and forming gas (observe national regulations)
- Protective gas box with fiber seal and cover with locks, inert gas introduction via a pipe into the bottom of the box
- Protective gas connection via quick coupling with hose connector (inner diameter 9 mm)
- Piping for gas inlet and outlet through the furnace collar
- Heat-resistant alloy 314 (AISI)/(DIN material no. 1.4841)
- Charge thermocouple type K for temperature display or charge control

Additional equipment

- Starting from LH 30/.. a charging cart is recommended see page 78
- Digital temperature display see page 69
- Gas supply systems see page 74
- Extended gas piping for the use of smaller boxes in larger furnace models
- Draw hook see page 77
- Charging stacker see page 79

Article no.	Furnace	Inner dimensions in mm			Outer dimensions in mm ¹			Charging method of the box
		w	d	h	W	D	H	
631001276	LH 15/..	100	100	100	165	182	166	draw hook
631001277	LH 30/..	170	170	170	235	252	236	draw hook
631001278	LH 60/..	250	250	250	315	332	316	draw hook
631001279	LH 120/..	350	350	350	415	411	441	draw hook
631001280	LH 216/..	450	450	400	514	535	554	charging stacker

Article no. 601655055, 1 set of fiber insulation cord, 5 strips of 610 mm each

Work space = box inner dimensions: - 30 mm to all sides

Larger boxes and custom dimensions available upon request

¹ Without piping



Protective gas box which stays in the furnace

Protective Gas Boxes with Charging from the Front

Design as the described protective gas boxes, but with charging from the front. These protective gas boxes remain in the oven and are equipped with a lid that can be opened to the front. After the lid has been opened, the batch can be removed directly.

Article no.	Furnace	Inner dimensions in mm			Outer dimensions in mm ¹			Charging method of the box
		w	d	h	W	D	H	
631001310	LH 15/..	100	100	100	170	148	194	-
631001311	LH 30/..	170	170	170	240	218	264	-
631001312	LH 60/..	250	250	250	320	298	344	-
631001313	LH 120/..	350	350	350	420	398	444	-

Article no. 601655055, 1 set of fiber insulation cord, 5 strips of 610 mm each

Work space = box inner dimensions: - 30 mm to all sides

Larger boxes and custom dimensions available upon request

¹ Without piping

Protective Gas Boxes with Evacuation Lid for Models LH 15/.. - LH 216/..

Design as the described protective gas boxes, but with an additional evacuation lid. In order to reduce the residual oxygen in the box, protective gas boxes with evacuation lids can be used. These boxes have a lid for top loading, a protective gas inlet and outlet, and an evacuation cover with rubber gasket. The gas piping and the handling in the warm state corresponds to the gassing boxes on page 56. In addition, a connection for a vacuum pump via three-way ball valve is provided.

In combination with a vacuum pump, the oxygen is evacuated from the box in cold state and afterwards flushed with protective gas. Repeating the process once or several times will significantly improve the results. After this process, the evacuation cover is removed and the actual heat treatment process is started under protective gas. After the heat treatment, the box is pulled out of the furnace and can be cooled in air or opened for batch removal.

- Protective gas box with fiber sealing and lid with locks, recess for evacuation lid, gas inlet via a pipe into the bottom of the box
- Evacuation lid with rubber sealing (Elastomer) and manometer
- Protective gas connection via threeway ball valve and quick coupling with hose connector (inner diameter 9 mm)

Additional equipment

- Starting from LH 30/.. a charging cart is recommended see page 78
- Digital temperature display see page 69
- Vacuum pump see page 75
- Gas supply systems see page 74
- Extended gas piping for the use of smaller boxes in larger furnace models
- Draw hook see page 77
- Charging stacker see page 79

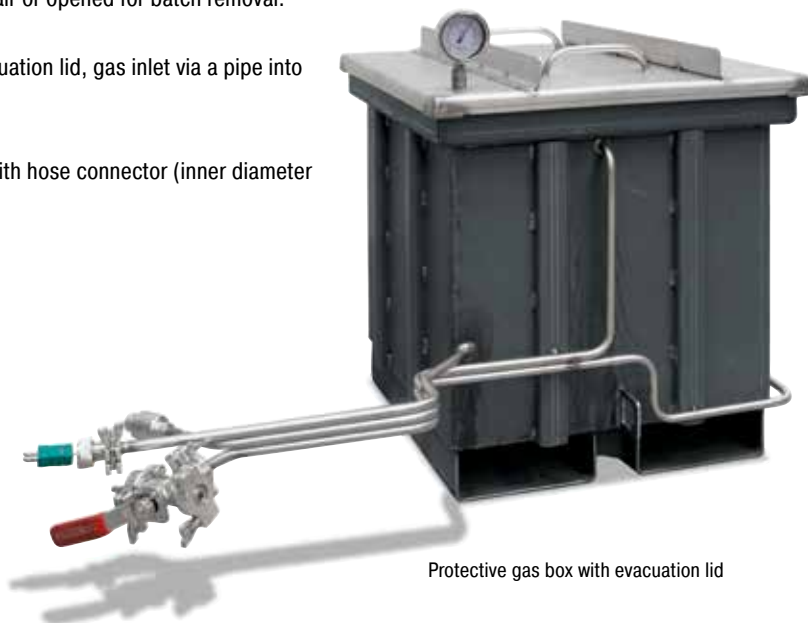

Protective gas box with evacuation lid

Article no.	Furnace	Inner dimensions in mm			Outer dimensions in mm ¹			Charging method of the box
		w	d	h	W	D	H	
631001281	LH 15/..	100	100	100	152	180	160	draw hook
631001282	LH 30/..	170	170	170	222	252	230	draw hook
631001283	LH 60/..	250	250	250	302	332	310	draw hook
631001284	LH 120/..	350	350	350	402	432	405	draw hook
631001285	LH 216/..	450	450	400	506	535	540	charging stacker

Article no. 601655055, 1 set of fiber insulation cord, 5 strips of 610 mm each

¹ Without piping and evacuation lid

Work space = box inner dimensions: - 30 mm to all sides

Larger boxes and custom dimensions available upon request

Charging plates for Models LH 15/.. - LH 216/..

Charging plates are recommended to protect the furnace floor. The charging plates are particularly suitable for heat treatment with protective gas boxes in order to minimize wear during charging.

- Tmax 1100 °C
- Threeside upstand
- Heat-resistant alloy 314 (AISI)/(DIN material no. 1.4841)
- With spacer o the rear heating elements



Charging plate

Article no.	Furnace	Outer dimensions in mm		
		W	D	H
628002013	LH 15/..	190	230	30
628002014	LH 30/..	260	300	30
628002015	LH 60/..	340	400	30
628002016	LH 120/..	440	500	30
628002017	LH 216/..	540	600	30

Chamber Furnaces with Drawer Bottom or as a Bogie



Chamber furnace NW 440 with free traversing bogie

The NW chamber furnaces enable simple charging for cold-cold processes. The heat treatment can take place under air or under non-flammable protective gases with a protective gas box or protective gas hood. With a drawer mechanism (NW 150 - NW 300/H) the furnace table can be easily pulled out of the chamber furnace. The larger models NW 440 - NW 1000/H are designed as shuttle furnace with completely free traversing bogie. Free access in front of the furnace allows for a simplified and clear charging.

- Tmax 1300 °C, 1100 °C with protective gas box (additional equipment)
- Dual shell housing, galvanized steel sheets
- Double-walled door with front made of textured stainless steel
- Controller mounted on furnace door and removable for comfortable operation (up to model NW 440)
- Heating from five sides with special arrangement of heating elements for optimum temperature uniformity
- Heating elements of support tubes provide for free radiation of the heat
- Multi-layer insulation with light-weight refractory bricks and high-quality, energy-saving backing insulation

- Vaulted ceiling
- Furnace table can be pulled-out as drawer (NW 150 - NW 300)
- From chamber furnace NW 440 bogie on four castors (two with brakes) which can be pulled out completely. Accession assistance and removable drawbar for bogie
- SiC-floor plate protects floor elements and provides a level setting surface
- Door sealing grinded by hand (brick on brick); NW 150 - NW 300
- Semi-automatic air inlet flap closes the air inlet at a temperature which can be set in the controller for NW 150 - NW 300
- Exhaust air outlet in the ceiling, motor driven exhaust air flap for chamber furnaces NW 440 - NW 1000
- Comfortable charging height with base of 800 mm (chamber furnaces NW 440 - NW 1000 = 500 mm)
- Defined application within the constraints of the operating instructions
- NTLLog for Nabertherm controller: recording of process data with USB-flash drive
- Controls description see page 88

Additional equipment

- Protective gas boxes and hoods
- Manual or automatic gas supply system
- Process control and documentation via VCD software package or Nabertherm Control Center (NCC) for monitoring, documentation and control see page 88



Chamber furnace NW 300 with pulled-out furnace table

Model	Tmax °C	Inner dimensions in mm			Volume in l	Outer dimensions in mm			Connected load kW	Electrical connection*	Weight in kg
		w	d	h		W	D	H			
NW 150	1300	430	530	620	150	790	1150	1600	11.0	3-phase	400
NW 200	1300	500	530	720	200	860	1150	1700	15.0	3-phase	460
NW 300	1300	550	700	780	300	910	1320	1760	20.0	3-phase	560
NW 440	1300	600	750	1000	450	1000	1400	1830	30.0	3-phase	970
NW 660	1300	600	1100	1000	660	1000	1750	1830	40.0	3-phase	1180
NW 1000	1300	800	1000	1250	1000	1390	1760	2000	57.0	3-phase	1800

*Please see page 89 for more information about supply voltage

Protective Gas Boxes and Protective Gas Hoods for Chamber Furnaces NW 150 - NW 1000

Protective Gas Boxes

These protective gas boxes have a cover with a sealing profile as well as a protective gas inlet and outlet. They are pulled out of the furnace in cold condition and charged from above.

- Tmax 1100 °C
- For non-combustible protective and reactive gases argon, nitrogen and forming gas (observe national regulations)
- Protective gas box with fiber seal and cover with locks, inert gas introduction via a pipe into the bottom of the box
- Protective gas connection via quick coupling with hose connector (inner diameter 9 mm)
- Piping for gas inlet and outlet through the furnace collar
- Forklift receptive
- Heat-resistant alloy 314 (AISI)/(DIN material no. 1.4841)
- Charge thermocouple type K for temperature display or charge control

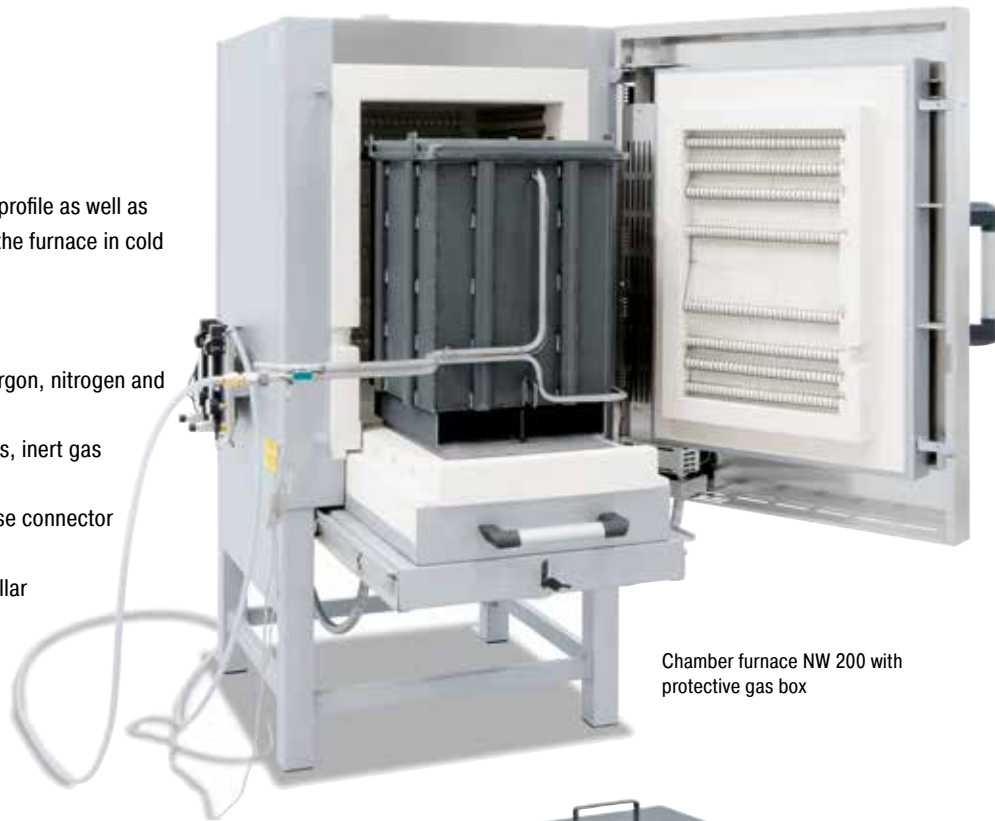

Chamber furnace NW 200 with protective gas box

Protective Gas Hoods

Protective gas hoods consist of a top and a bottom with a sealing profile as well as protective gas inlet and outlet. After charging the bottom in front of the oven in cold condition, the hood is put on and the drawer or the car is pushed back into the oven.

Design as protective gas boxes, but

- Gassing hood with eye for raising the hood by crane
- Hood bottom with sealing
- Piping for gas inlet and outlet at the hood through the furnace collar



Protective gas box for similar furnace

Additional equipment for protective gas boxes and hoods

- Digital temperature display see page 69
- Gas supply systems see page 74

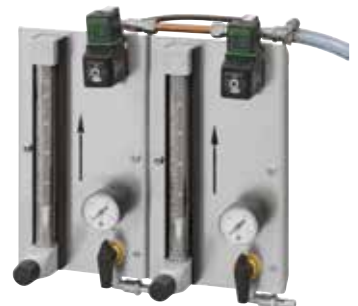

Two automatic gas supply systems, connected with each other

Furnace	Article no. Protective gas box	Inner dimensions in mm		
		w	d	h
NW 150	631001329	330	420	400
NW 200	631001330	400	420	500
NW 300	631001331	450	550	550
NW 440	631001332	500	600	750
NW 660	631001333	500	750	750
NW 1000	on request			

Article no. Protective gas hood	Inner dimensions in mm			Charging the furnace
	w	d	h	
631001334	300	360	400	Drawer
631001335	370	360	450	Drawer
631001336	420	530	500	Drawer
631001337	470	580	550	On a bogie
631001338	470	750	550	On a bogie
	on request			On a bogie

Article no. 601655055, 1 set of fiber insulation cord, 5 strips of 610 mm each
 Work space = box inner dimensions: - 30 mm to all sides
 Larger boxes and custom dimensions available upon request

Forced Convection Chamber Furnaces < 675 Liters Electrically Heated



Forced convection chamber furnace
NA 120/45



Forced convection chamber furnace NA 250/45



Forced convection chamber furnace
NA 15/65 as table-top model

The very good temperature uniformity of these chamber furnace with air circulation provides for ideal process conditions for annealing, curing, solution annealing, artificial ageing, preheating, or soft annealing and brazing. The forced convection chamber furnaces are equipped with a suitable annealing box for soft annealing of copper or tempering of titanium, and also for annealing of steel under non-flammable protective or reaction gases. The modular forced convection chamber furnace design allows for adaptation to specific process requirements with appropriate accessories.

- Tmax 450 °C, 650 °C, or 850 °C
- Stainless steel air-baffles in the furnace for optimum air circulation
- Swing door hinged on the right side
- Base frame included in the delivery, NA 15/65 designed as table-top model
- Horizontal air circulation
- Temperature uniformity up to +/- 4 °C according to DIN 17052-1 (model NA 15/65 up to +/- 5 °C) see page 84
- Optimum air distribution enabled by high flow speeds
- One frame sheet and rails for two additional trays included in the scope of delivery (NA 15/65 without frame sheet)
- Defined application within the constraints of the operating instructions
- NTLog Basic for Nabertherm controller: recording of process data with USB-flash drive
- Controls description see page 88

Additional equipment (not for model NA 15/65)

- Optimization of the temperature uniformity up to +/- 3 °C according to DIN 17052-1 see page 84
- Air inlet and exhaust air flaps when used for drying
- Controlled cooling with fan
- Manual lift door (up to model N(A) 120/.. (HA))
- Pneumatic lift door
- Air circulation with speed control, recommendable for processes with light or sensitive charge
- Additional frame sheet
- Roller conveyor in furnace chamber for heavy charges



Forced convection chamber furnace
NA 500/45S with four compartments, each
with roller conveyor and individual door



Forced convection chamber furnace
NA 500/65



Forced convection chamber furnace
N 250/85HA with quenching bath

- Annealing boxes
- Feed and charging aids
- Safety technology according to EN 1539 (NFPA 86) (models NA .. LS) for charges containing solvents
- Inlets, measuring frames and thermocouples for TUS measurements charge or comparative measurements
- Charge control
- Process control and documentation via VCD software package or Nabertherm Control Center (NCC) for monitoring, documentation and control see page 88



Roller conveyor in forced convection
chamber furnace N 250/85HA

Model	Tmax °C	Inner dimensions in mm			Volume in l	Outer dimensions in mm			Heating power in kW ³ NA/NA .. LS	Electrical connection*	Weight in kg	Heat-up time ⁵ to Tmax in minutes		Cool-down time ⁵ from Tmax to 150 °C in minutes	
		w	d	h		W	D	H				Flaps ⁴	Fan cooling ⁴		
NA 30/45(LS)	450	290	420	260	30	1040	1290	1385	3.0 / 9.0	1(3)-phase	285	120	120	30	
NA 60/45(LS)	450	350	500	350	60	1100	1370	1475	6.0 / 12.0	3-phase	350	120	240	30	
NA 120/45(LS)	450	450	600	450	120	1250	1550	1550	9.0 / 18.0	3-phase	460	60	240	30	
NA 250/45(LS)	450	600	750	600	250	1350	1650	1725	12.0 / 24.0	3-phase	590	60	120	30	
NA 500/45(LS)	450	750	1000	750	500	1550	1900	1820	18.0 / 24.0	3-phase	750	60	240	30	
NA 675/45(LS)	450	750	1200	750	675	1550	2100	1820	24.0 / 30.0	3-phase	900	90	270	60	
NA 15/65 ¹	650	295	340	170	15	470	790	460	2.8	1-phase	60	40	-	-	
NA 30/65	650	290	420	260	30	870	1290	1385	6.0	3-phase ²	285	120	270	60	
NA 60/65	650	350	500	350	60	910	1390	1475	9.0	3-phase	350	120	270	60	
NA 120/65	650	450	600	450	120	990	1470	1550	12.0	3-phase	460	60	300	60	
NA 250/65	650	600	750	600	250	1170	1650	1680	20.0	3-phase	590	90	270	60	
NA 500/65	650	750	1000	750	500	1290	1890	1825	27.0	3-phase	750	60	240	60	
NA 675/65	650	750	1200	750	675	1290	2100	1825	27.0	3-phase	900	90	270	90	
N 30/85 HA	850	290	420	260	30	607 + 255	1175	1315	5.5	3-phase ²	195	180	900	90	
N 60/85 HA	850	350	500	350	60	667 + 255	1250	1400	9.0	3-phase	240	150	900	120	
N 120/85 HA	850	450	600	450	120	767 + 255	1350	1500	13.0	3-phase	310	150	900	120	
N 250/85 HA	850	600	750	600	250	1002 + 255	1636	1860	20.0	3-phase	610	180	900	180	
N 500/85 HA	850	750	1000	750	500	1152 + 255	1886	2010	30.0	3-phase	1030	180	900	210	
N 675/85 HA	850	750	1200	750	675	1152 + 255	2100	2010	30.0	3-phase	1350	210	900	210	

¹Table-top model see page 60

²Heating only between two phases

³Depending on furnace design connected load might be higher

*Please see page 89 for more information about supply voltage

⁴Additional equipment

⁵Empty furnace

Protective Gas Boxes for Models NA 30/45 - N 500/85HA



Protective gas box with insertations



Forced convection chamber furnace N 250/85 HA with protective gas box

For the heat treatment, workpieces are placed in the box, the lid is locked using the sealing locks and flushed with protective gas outside the furnace for some time and then placed in the furnace. Depending on the weight, a charging cart (page 30) is recommended.

Basic Version

- For non-combustible protective and reactive gases argon, nitrogen and forming gas (observe national regulations)
- Protective gas box with fiber seal and cover with locks, inert gas introduction via a pipe into the bottom of the box
- Protective gas connection via quick coupling with hose connector (inner diameter 9 mm)
- Piping for gas inlet and outlet through the furnace collar
- Models N 250/..HA, NA 250/.., N 500/..HA und NA 500/.. will be delivered without bottom frame sheet
- Heat-resistant alloy: 309 (AISI)/(DIN material no. 1.4828)
- Charge thermocouple type K for temperature display or charge control

Additional equipment

- Digital temperature display see page 69
- Gas supply systems see page 74
- Extended gas piping for the use of smaller boxes in larger furnace models
- Draw hook see page 77
- Charging cart see page 78



Protective gas box with extended piping for usage in a large furnace model

Article no. (Furnace with hinged door)	Article no. (Furnace with lift door)	Furnace	Inner dimensions in mm			Outer dimensions in mm ¹			Charging method of the box
			w	d	h	W	D	H	
631000410	631000763	NA 30/.., N 30/..HA	220	320	160	282	376	242	draw hook
631000411	631000764	NA 60/.., N 60/..HA	270	420	260	336	460	340	draw hook
631000412	631000765	NA 120/.., N 120/..HA	350	520	340	436	560	430	draw hook
631000413	631000766	NA 250/.., N 250/..HA	480	630	460	546	680	600	charging stacker
631000414	631000767	NA 500/.., N 500/..HA	630	780	610	696	836	760	charging stacker

Article no. 601655055, 1 set of fiber insulation cord, 5 strips of 610 mm each

Work space = box inner dimensions: - 30 mm to all sides

Larger boxes and custom dimensions available upon request

¹ Without piping

Protective Gas Boxes with Evacuation Lid for Models NA 30/45 - N 500/85HA



Design as the boxes described above, but with additional evacuation lid and connection. Before the box is placed in the furnace, in a cold state an evacuation and protective gas atmosphere are alternately generated to force out the oxygen and achieve a pure atmosphere.

- Protective gas box with fiber sealing and lid with locks, recess for evacuation lid, gas inlet via a pipe into the bottom of the box
- Evacuation lid with rubber sealing (Elastomer) and manometer
- Protective gas connection via threeway ball valve and quick coupling with hose connector (inner diameter 9 mm)
- Piping for gas inlet and outlet through the furnace collar

Protective gas box with evacuation lid

Additional equipment

- Digital temperature display see page 69
- Vacuum pump see page 75
- Gas supply systems see page 74
- Extended gas piping for the use of smaller boxes in larger furnace models
- Draw hook see page 77
- Charging cart see page 78

Article no. (Furnace with hinged door)	Article no. (Furnace with lift door)	Furnace	Inner dimensions in mm			Outer dimensions in mm ¹			Charging method of the box
			w	d	h	W	D	H	
631000559	631000806	NA 30/.., N 30/..HA	170	300	130	258	388	222	draw hook
631000560	631000807	NA 60/.., N 60/..HA	230	380	220	318	468	297	draw hook
631000561	631000808	NA 120/.., N 120/..HA	330	480	320	418	568	412	draw hook
631000562	631000809	NA 250/.., N 250/..HA	430	580	370	518	668	532	charging stacker
631000563	631000810	NA 500/.., N 500/..HA	560	810	530	648	898	692	charging stacker

Article no. 601655055, 1 set of fiber insulation cord, 5 strips of 610 mm each

Work space = box inner dimensions: - 30 mm to all sides

Larger boxes and custom dimensions available upon request

¹ Without piping and evacuation lid

Protective Gas Boxes for Automotive (CQI-9) and Aeronautic (AMS7NADCAP) Norms

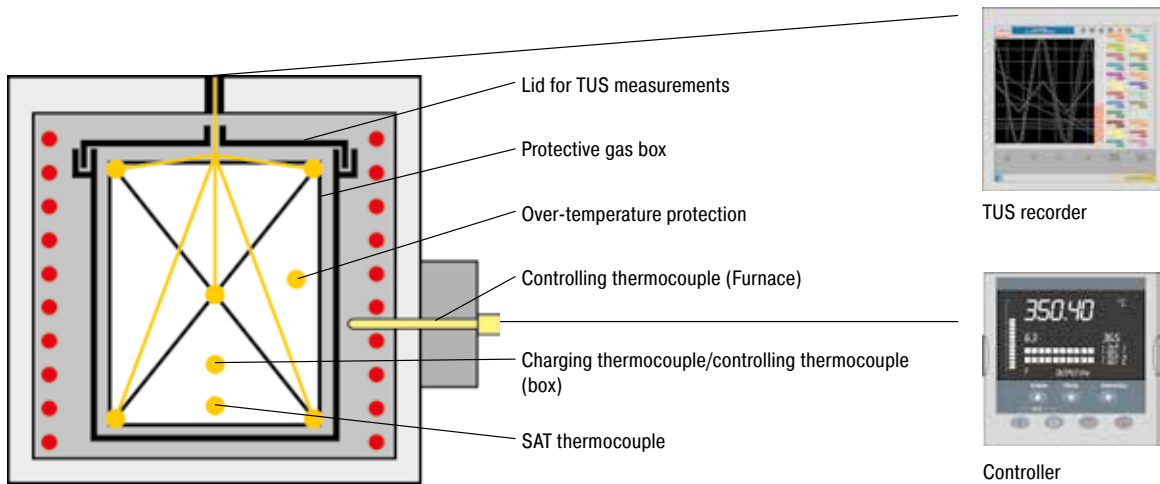

Protective Gas Boxes According to AMS 2750 E, Instrumentation Type D for Forced Convection Furnaces

These boxes are based on the standard protective gas boxes for furnaces with hinged door. To fulfill AMS 2750 E, instrumentation, type D requirements the boxes are equipped with necessary measuring ports.

- Temperature uniformity class 2: +/- 5 °C in useful space
- Additional port for customers flexible SAT thermocouple with max. 1,5 mm diameter
- Thermocouple, overtemperature protection, metal clad thermocouple, type N with plug

Article no. (Furnace with swinging door)	(Furnace with lift door)	Furnace	Inner dimensions in mm			Outer dimensions in mm ¹		
			w	d	h	W	D	H
631000410	631000763	NA 30/..., N 30/..HA	220	320	160	282	376	242
631000411	631000764	NA 60/..., N 60/..HA	270	420	260	336	460	340
631000412	631000765	NA 120/..., N 120/..HA	350	520	340	436	560	430
631000413	631000766	NA 250/..., N 250/..HA	480	630	460	546	680	600
631000414	631000767	NA 500/..., N 500/..HA	630	780	610	696	836	760

Article no. 601655055, 1 set of fiber insulation cord, 5 strips of 610 mm each

¹ Without piping

Work space = box inner dimensions: - 30 mm to all sides

Larger boxes and custom dimensions available upon request

Protective Gas Boxes with Evacuation Lid According to AMS 2750 E, Instrumentation type D

These boxes are based on the standard protective gas boxes with evacuation lid for furnaces with hinged door.

Before the box is placed in the furnace, in a cold state an evacuation and protective gas atmosphere are alternately generated to force out the oxygen and achieve a pure atmosphere.

- Temperature uniformity class 2: +/- 5 °C in useful space
- Additional port for customers flexible SAT thermocouple with max. 1,5 mm diameter
- Thermocouple, overtemperature protection, metal clad thermocouple, type N with plug

Protective gas box with evacuation lid according to AMS 2750 E

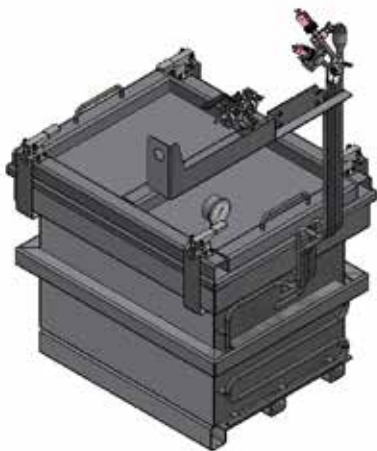

Article no. (Furnace with hinged door)	(Furnace with lift door)	Furnace	Inner dimensions in mm			Outer dimensions in mm ¹		
			w	d	h	W	D	H
631001049	631001054	NA 30/..., N 30/..HA	170	300	130	258	388	222
631001050	631001055	NA 60/..., N 60/..HA	230	380	220	318	468	297
631001051	631001056	NA 120/..., N 120/..HA	330	480	320	418	568	412
631001052	631001057	NA 250/..., N 250/..HA	430	580	370	518	668	532
631001053	631001058	NA 500/..., N 500/..HA	560	810	530	648	898	692

Article no. 601655055, 1 set of fiber insulation cord, 5 strips of 610 mm each

¹ Without piping

Work space = box inner dimensions: - 30 mm to all sides

Larger boxes and custom dimensions available upon request

Sealed Forced Convection Chamber Furnaces NA-I and NA-SI

Sealed forced convection chamber furnaces are suitable if a heat treatment process up to 650 °C requires a protective gas atmosphere that does not have to be completely oxygen free.

The difference between the two variants is that the I-model only has a sealed outer housing while the SI-model has a welded inner box, which further reduces the residual oxygen concentration.

NA-I design

Like forced convection chamber furnaces < 675 l (page 60) with the following changes

- Tmax 450 °C and 650 °C
- Silicone door seal
- Furnace housing sealed with silicone
- Protective gas connection in the back wall
- Defined application within the constraints of the operating instructions
- Residual oxygen concentration < 1 % depending on the volume and type of protective gas
- For non-flammable protective and reaction gases such as argon, nitrogen, and forming gas (national regulations must be considered)

NA-SI design

Additional features

- Tmax 650 °C
- Welded inner housing
- 2-sided heating and air circulation
- Door sealed with seal gas
- Sealed connection to circulation motor
- Gas inlet via circulator shaft
- Defined application within the constraints of the operating instructions
- Residual oxygen concentration to 0.1 % depending on the volume and type of protective gas
- For non-flammable protective and reaction gases such as argon, nitrogen, and forming gas (national regulations must be considered)



Forced convection chamber furnace NA 120/65 I



Forced convection chamber furnace NA 15/65 l as tabletop model with manual gas supply system

Model	Tmax °C	Inner dimensions in mm			Volume in l	Outer dimensions in mm			Heating power in kW ³	Electrical connection*	Weight in kg
		w	d	h		W	D	H			
NA 30/45 I	450	290	420	260	30	1040	1290	1385	3.0	1(3)-phase	285
NA 60/45 I	450	350	500	350	60	1100	1370	1475	6.0	3-phase	350
NA 120/45 I	450	450	600	450	120	1250	1550	1550	9.0	3-phase	460
NA 250/45 I	450	600	750	600	250	1350	1650	1725	12.0	3-phase	590
NA 500/45 I	450	750	1000	750	500	1550	1900	1820	18.0	3-phase	750
NA 675/45 I	450	750	1200	750	675	1550	2100	1820	24.0	3-phase	900
NA 15/65 I ¹	650	295	340	170	15	470	790	460	2.8	1-phase	60
NA 30/65 I	650	290	420	260	30	870	1290	1385	5.0	3-phase ²	285
NA 60/65 I (SI)	650	350	500	350	60	910	1390	1475	9.0	3-phase	350
NA 120/65 I (SI)	650	450	600	450	120	990	1470	1550	12.0	3-phase	460
NA 250/65 I (SI)	650	600	750	600	250	1170	1650	1680	20.0	3-phase	590
NA 500/65 I (SI)	650	750	1000	750	500	1290	1890	1825	27.0	3-phase	750
NA 675/65 I	650	750	1200	750	675	1290	2100	1825	27.0	3-phase	900

¹Table-top model

²Heating only between two phases

*Please see page 89 for more information about supply voltage

³Depending on furnace design connected load might be higher

Forced Convection Pit-Type Furnaces Electrically Heated



Pit-type furnace SAL 120/65 with protective gas retort box and cooling station next to the furnace

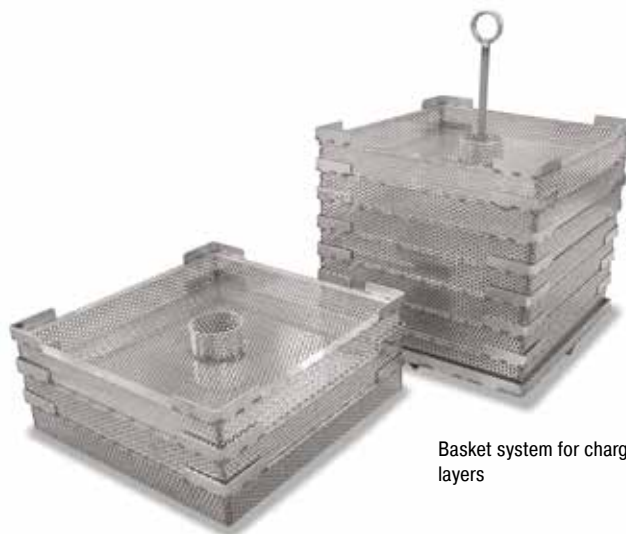

Basket system for charging in different layers

Forced convection pit-type furnaces offer the advantage of easy charging, for heat treatment of heavy parts or loads in charge baskets. With maximum application temperatures available from 450 °C to 850 °C, these compact pit-type furnaces are particularly useful for processes such as tempering, solution annealing, artificial ageing, and soft annealing.

- Tmax 450 °C, 650 °C, 850 °C
- Air circulation fans in the furnace bottom, high circulation rate
- Vertical air circulation with square air heating chamber
- Temperature uniformity up to +/- 4 °C according to DIN 17052-1 see page 84
- Interior walls from stainless steel
- Switchgear with solid-state relays
- Defined application within the constraints of the operating instructions
- NTLLog Basic for Nabertherm controller: recording of process data with USB-flash drive
- Controls description see page 88

Additional equipment

- Charging hoist with swivel arm and charge basket
- Optimization of the temperature uniformity up to +/- 2 °C according to DIN 17052-1 see page 84
- Integrated fan for rapid cool down or separate cooling station for annealing box cooling outside of the furnace
- Annealing box with protective gas inlet and outlet for production in a defined atmosphere
- Manual or automatic gas supply systems for non-flammable protective or reaction gases
- Process control and documentation via VCD software package for monitoring, documentation and control see page 88



SAL 250/65



Protective gas box, AMS 2750 E design

Model	Tmax °C	Inner dimensions in mm			Volume in l	Max. charging weight in kg	Outer dimensions in mm			Heating power in kW ²	Electrical connection*	Weight in kg
		w	d	h			W	D	H			
SAL 30/45	450	300	250	400	30	120	750	850	1250	3.0	1-phase	130
SAL 60/45	450	350	350	500	60	120	800	950	1350	6.0	3-phase	225
SAL 120/45	450	450	450	600	120	120	900	1050	1450	9.0	3-phase	280
SAL 250/45	450	600	600	750	250	400	1050	1200	1600	18.0	3-phase	750
SAL 500/45	450	750	750	900	500	400	1200	1350	1750	27.0	3-phase	980
SAL 30/65	650	300	250	400	30	120	750	850	1250	5.5	3-phase ¹	130
SAL 60/65	650	350	350	500	60	120	800	950	1350	9.0	3-phase	225
SAL 120/65	650	450	450	600	120	120	900	1050	1450	13.0	3-phase	280
SAL 250/65	650	600	600	750	250	400	1050	1200	1600	20.0	3-phase	750
SAL 500/65	650	750	750	900	500	400	1200	1350	1750	30.0	3-phase	980
SAL 30/85	850	300	250	400	30	80	600	740	1000	5.5	3-phase ¹	130
SAL 60/85	850	350	350	500	60	80	800	950	1350	9.0	3-phase	225
SAL 120/85	850	450	450	600	120	80	900	1050	1450	13.0	3-phase	280
SAL 250/85	850	600	600	750	250	250	1050	1200	1600	20.0	3-phase	750
SAL 500/85	850	750	750	900	500	250	1200	1350	1750	30.0	3-phase	980

¹Heating only between two phases

²Depending on furnace design connected load might be higher

*Please see page 89 for more information about supply voltage

Charging Aid for Models SAL 30/45 - SAL 500/85

A charging aid, fastened to the furnace consisting of a swivel arm and winch is recommended for charging series SAL 30/45A - SAL 250/85 forced convection pit-type furnaces with protective gas boxes or baskets. This allows easy and safe furnace charging.

- Swivel arm, mounted on side of furnace
- For ease of charging and removal of Nabertherm charging baskets and protective gas boxes
- Winch with hand crank
- Max. charging weight 140 kg

Furnace	Total height in mm
SAL 30/.. - SAL 120/..	2400
SAL 250/..	2600
SAL 500/..	3010



Swivel arm mounted on furnace

Protective Gas Boxes for Models SAL 30/45 - SAL 500/85

For tempering and bright annealing, workpieces are laid in the box, the lid is pressed firmly shut using the sealing locks and flushed with protective gas outside the box for some time and then placed in the furnace. Due to weight reasons we recommend to use a charging aid for charging.

- For non-combustible protective and reactive gases argon, nitrogen and forming gas (observe national regulations)
- Protective gas box with fiber seal and cover with locks, inert gas introduction via a pipe into the bottom of the box
- Protective gas connection via quick coupling with hose connector (inner diameter 9 mm)
- Piping for gas inlet and outlet through the furnace collar
- Heat-resistant alloy: 450 °C - 304 (AISI)/(DIN material no. 1.4301), 650 °C - 321 (AISI)/(DIN material no. 1.4541) or 850 °C - 309 (AISI)/(DIN material no. 1.4828)
- Charging aid lifting eyes
- Charge thermocouple type K for temperature display or charge control

Additional equipment

- Digital temperature display see page 69
- Gas supply systems see page 74



Protective gas box with sealing lock

Article no. with charge thermocouple	Furnace	Inner dimensions in mm			Outer dimensions in mm ¹		
		w	d	h	W	D	H
631000500	SAL 30/45	215	165	277	281	231	354
631000501	SAL 60/45	265	265	377	331	331	454
631000502	SAL 120/45	365	365	477	431	431	554
631000503	SAL 250/45	515	515	627	581	561	704
631000504	SAL 500/45	665	665	727	731	731	804
631000505	SAL 30/65	215	165	277	281	231	354
631000506	SAL 60/65	265	265	377	331	331	454
631000507	SAL 120/65	365	365	477	431	431	554
631000508	SAL 250/65	515	515	627	581	561	704
631000509	SAL 500/65	665	665	727	731	731	804
631000510	SAL 30/85	215	165	277	281	231	354
631000511	SAL 60/85	265	265	377	331	331	454
631000512	SAL 120/85	365	365	477	431	431	554
631000513	SAL 250/85	515	515	627	581	561	704
631000514	SAL 500/85	665	665	727	731	731	804

Article no. 601655055, 1 sales unit of fiber insulation cord, 5 strips of 610 mm each

¹ Without piping

Charging Baskets for Models SAL 30/45 - SAL 500/85

The workpieces are placed in basket for tempering. We recommend the use of a charging aid for charging.



Charging basket for top charging

- Heat-resistant charging basket for small parts and bulk materials, incl. handle or crane lifting eyes
- Filling from above
- Hole size 12 mm
- Heat-resistant alloy: 450 °C - 304 (AISI)/(DIN material no. 1.4301), 650 °C - 321 (AISI)/(DIN material no. 1.4541) or 850 °C - 309 (AISI)/(DIN material no. 1.4828)

Article no.	Furnace	Inner dimensions in mm		
		w	d	h
631000477	SAL 30/45	210	180	350
631000478	SAL 60/45	260	280	450
631000479	SAL 120/45	360	380	550
631000480	SAL 250/45	510	530	650
631000481	SAL 500/45	570	570	750
631000266	SAL 30/65	210	180	350
631000267	SAL 60/65	260	280	450
631000268	SAL 120/65	360	380	550
631000269	SAL 250/65	510	530	650
631000270	SAL 500/65	570	570	750
631000482	SAL 30/85	210	180	350
631000483	SAL 60/85	260	280	450
631000484	SAL 120/85	360	380	550
631000485	SAL 250/85	510	530	650
631000486	SAL 500/85	570	570	750

The workpieces are placed on different levels for tempering. We recommend the use of a charging aid for charging.



Special charging basket with 3 drawers (4 levels) for side charging

- Heat-resistant charging basket, incl. handle/crane lifting eyes
- Charged from side via 2 drawers (3 levels)
- Hole size 12 mm
- Heat-resistant alloy: 450 °C - 304 (AISI)/(DIN material no. 1.4301), 650 °C - 321 (AISI)/(DIN material no. 1.4541) or 850 °C - 309 (AISI)/(DIN material no. 1.4828)

Article no.	Furnace	Inner dimensions in mm		
		w	d	h
631006124	SAL 30/45	230	180	400
631006036	SAL 60/45	280	280	450
631006037	SAL 120/45	344	344	500
631006038	SAL 250/45	490	490	720
631006039	SAL 500/45	660	660	770
631006040	SAL 30/65	230	180	400
631006041	SAL 60/65	280	280	450
631006042	SAL 120/65	344	344	500
631006043	SAL 250/65	490	490	720
631006044	SAL 500/65	660	660	770
631006045	SAL 30/85	230	180	400
631006046	SAL 60/85	280	280	450
631006047	SAL 120/85	344	344	500
631006048	SAL 250/85	490	490	720
631006049	SAL 500/85	660	660	770

The workpieces are placed on different levels for tempering. We recommend the use of a charging aid for charging.

- Heat-resistant charging basket for small parts and bulk materials, incl. handle/crane lifting eyes
- Charged in different floors
- Hole size 12 mm
- Heat-resistant alloy: 450 °C - 304 (AISI)/(DIN material no. 1.4301), 650 °C - 321 (AISI)/(DIN material no. 1.4541) or 850 °C - 309 (AISI)/(DIN material no. 1.4828)

Article no.	Furnace	No. of baskets	Max. charge weight per basket	Inner dimensions in mm		
				w	d	h
631006106	SAL 250/85	7	10 kg	530	530	100



Basket for charging in different floors

Temperature Measurement in Gas Supply Systems

The use of a thermometer with thermocouple is recommended for determining the exact heat treatment temperature in protective gas boxes or gas feed annealing bags with holders. The thermocouple is permanently mounted on the respective protective gas boxes or gas feed annealing bag holder. A simple manual thermometer with LCD display or a temperature indicator with LED display can be supplied, mounted in a separate metal housing. Both are equipped with a two-pole plug unit for connecting to the thermocouple. The temperature can be determined in this way and, if necessary, readjusted on the controller.

Upon request, the furnace can be operated by charge control with a thermocouple attached to the workpiece.



Thermostat (manual device)

Article no.	Description
402000057	Temperature indicator with digital display, 230 V 1/N connection, in metal housing
542100028	Temperature indicator with digital display, battery-operated, manual device
V000808	Connecting cable between heat treatment with charge thermocouple and Article no. 402000057, 5 m
V000801	Connecting cable between heat treatment with charge thermocouple and Article no. 542100028, 3 m

TUS Measuring Frame for Protective Gas Box



To carry out the temperature uniformity measurement (TUS) the protective gas box will be equipped with a second lid. The TUS measuring frame is fixed to the lid and it is equipped with measuring port for thermocouples.

- Tmax 1100 °C
- Useful for all relevant TUS norms
- Under the assumption that the furnace is equipped with a measuring port for themocouples
- Heat-resistant alloy 314 (AISI)/(DIN material no. 1.4828)
- Thermocouples not included



TUS Measuring Frame for Protective Gas Box

Tool Shop Hardening System KHS 17



Tool shop hardening system KHS 17

The work platform of the system is designed to carry an N 7/H - N 17/H series hardening furnace and NA 15/65 annealing furnace. Suitable protective gas boxes can be used. A movable oil/water bath for quenching and subsequent cleaning is positioned below the furnaces. This compact system is a practical solution if space is an issue.

After heat treatment in the hardening furnace, the parts are removed from the

furnace or the gas feed box and quenched in an oil quench bath or water bath. The charging basket can be used to move the part within the bath so that it cools more evenly. After quenching in oil the workpiece should be cleaned in the water bath, dried and immediately tempered in a forced convection furnace in order to optimally fix the mechanical components with regard to their strength behavior for the required conditions, minimize distortion and prevent potential flaws.

Additional equipment

- Protective gas boxes see page 45 - 48
- Protective gas annealing bag and holder see page 49
- Gas supply systems see page 74
- Charging forks see page 47

Model	Tmax °C	Inner dimensions in mm			Volume in l	Outer dimensions in mm			Heating power in kW ²	Electrical connection*	Weight in kg
		w	d	h		W	D	H			
N 7/H	1280	250	250	120	7	720	640	510	3.0	1-phase	60
N 11/H	1280	250	350	140	11	720	740	510	3.6	1-phase	70
N 11/HR	1280	250	350	140	11	720	740	510	5.5	3-phase ¹	70
N 17/HR	1280	250	500	140	17	720	890	510	6.4	3-phase ¹	90
N 15/65HA	650	295	340	170	15	470	845	460	2.4	1-phase	55

¹Heating only between two phases

²Depending on furnace design connected load might be higher

*Please see page 89 for more information about supply voltage

Article no.	Article	Outer dimensions in mm			Charging floor grid dimensions	
		W	D	H	Width in mm	length in mm
401000104	Work table with quenching and cleaning bath	735	850	1155	-	-
401000102	Charging basket for quenching and cleaning bath	-	-	-	215	635

Tool Shop Hardening System MHS 17

The MHS 17 hardening system has a modular design and consists of a work platform for the heat treating furnaces, an oil bath for quenching and water bath for cleaning parts. As an option both baths can be delivered incl. heating. The baths are mounted to the left and right of the work platform and have charging baskets in order to induce even cooling of the parts in the bath. All parts may be ordered separately meaning the hardening system can be retrofitted or equipment added individually depending on the materials processed.

The MHS 17 can have an air quenching system added to it for air-hardened steels. This platform has a powerful cooling fan to force cool the parts requiring hardening and also the gas feed annealing bag and holder. A refractory brick base is for placing hot boxes and workpieces on them. The quenching baths can also be fastened onto the forced cooling system.

An additional storage platform can be integrated within the system for holding accessory equipment and/or optional charging accessories.

Additional equipment see page 70.



MHS 17

Model	Tmax °C	Inner dimensions in mm			Volume in l	Outer dimensions in mm			Heating power in kW ²	Electrical connection*	Weight in kg
		w	d	h		W	D	H			
for MHS 17											
N 7/H	1280	250	250	120	7	720	640	510	3.0	1-phase	
N 11/H	1280	250	350	140	11	720	740	510	3.6	1-phase	70
N 11/HR	1280	250	350	140	11	720	740	510	5.5	3-phase ¹	70
N 17/HR	1280	250	500	140	17	720	890	510	6.4	3-phase ¹	90
N 15/65HA	650	295	340	170	15	470	845	460	2.4	1-phase	55

¹Heating only between two phases

²Depending on furnace design connected load might be higher

*Please see page 89 for more information about supply voltage

Article no.	Article	Outer dimensions in mm			Volume in l	Charging floor grid dimensions		Connected load kW	Supply voltage
		W	D	H		Width in mm	length in mm		
631006421	Work platform	1000	850	760	-	-	-	-	-
631006407	Oil bath	280	510	510	50	400	200	-	-
631006408	Water bath	280	510	510	50	400	200	-	-
631001011	Heating element (oil bath)	-	-	-	-	-	-	3,0	230 V
631001012	Heating element (water bath)	-	-	-	-	-	-	3,0	230 V
631000429	Forced cooling system (cooling platform)	560	610	760	-	400	200	0,2	230 V
631000442	Side platform	560	610	760	-	-	-	-	-

Tool Shop Hardening Systems MHS 31, MHS 41 and MHS 61



These toolshop hardening systems are suitable for hardening larger components in air or under a protective gas atmosphere. The systems can be assembled from a chamber furnace, a forced convection furnace, a protective gas box with a gas supply via a solenoid valve, a charging plate to floor, and a quenching bath with heating element. During the heat treatment under protective gas, the process starts with the flushing of the batch in the protective gas box by means of protective gas. Subsequently, annealing is carried out in the chamber furnace at a lower process flushing rate. The chamber furnace is opened after the annealing process and the batch is removed from the protective gas box to be quenched in the preheated quench bath. The final annealing process takes place in the forced convection furnace. For easier charging, we recommend the use of optional charging aids such as pull hooks and charging trolleys.

The toolshop hardening systems are an assembly of furnaces and accessories from our standard range. All components can also be ordered separately.

Additional equipment

- Draw hook see page 77
- Charging cart see page 78

	Model	Tmax °C	Inner dimensions in mm			Charging height in mm	Outer dimensions in mm			Heating power in kW ²	Electrical connection*	Weight in kg
			w	d	h		W	D	H			
MHS 31	N 31/H	1280	350	350	250	900	1040	1100	1340	15	3-phase	210
	NA 30/65	650	290	420	260	900	870	1290	1385	5	3-phase ¹	285
	Quenching bath Q 50	-	200	170	-	700	350	350	700	-	-	-
	Heating element	-	-	-	-	-	-	-	-	3	1-phase	-
MHS 41	N 41/H	1280	350	500	250	900	1040	1250	1340	15	3-phase	260
	NA 60/65	650	350	500	350	900	910	1390	1475	9	3-phase	350
	Quenching bath Q 50	-	200	170	-	700	350	350	700	-	-	-
	Heating element	-	-	-	-	-	-	-	-	3	1-phase	-
MHS 61	N 61/H	1280	350	750	250	900	1040	1500	1350	20	3-phase	400
	NA 60/65	650	350	500	350	900	910	1390	1475	9	3-phase	350
	Quenching bath Q 50	-	200	170	-	700	350	350	700	-	-	-
	Heating element	-	-	-	-	-	-	-	-	3	1-phase	-
Accessories	Charging cart CW1	-	-	-	-	880 - 920	330	1100	880 - 920	-	-	-
	Charging cart CWK1	-	-	-	-	880 - 920	330	1100	880 - 920	0,2	1-phase	-
	Side platform	-	600	600	-	900	600	600	900	-	-	-
	Protective gas box N 31/H	1100	280	230	200	-	316	304	226	-	-	-
	Protective gas box N 41/H	1100	280	380	200	-	316	454	226	-	-	-

¹Heating only between two phases

²Depending on furnace design connected load might be higher

*Please see page 89 for more information about supply voltage

Protective Gas Hardening System SHS 41

This compact, semi-automatic system is suitable for hardening in a protective gas atmosphere followed by quenching of the workpiece in oil. In this way, even larger parts can be annealed under a protective gas and quenched. It consists of a chamber furnace N 41/H hardening furnace with a pneumatic door opening and charging plates as well as an oil quench bath on rollers with an integrated pneumatic lowering unit, a floor grid with gas hood, a holding unit for the gas hood as well as a rim exhaust with flame trap.

The workpiece is placed on the floor grid and covered with the gas hood. After preflushing with protective gas, the gas hood is pushed with the floor grid into the chamber furnace. After the heat treatment is completed, the workload is pulled out of the furnace onto the lowering unit. The hood remains above the quenching bath while the charging floor grid is lowered pneumatically. In order to obtain best quenching results, the pneumatic lowering unit is moved up and down in the oil quench bath. After completion, the workload is moved into unloading position.

This low cost system can be used for hardening processes which otherwise could only be handled in complex furnace systems.



Protective gas hardening system with furnace N 41/H

- Chamber furnace N 41/H
- Pneumatic pedal switch operated door opening
- Charging plate
- Oil quench bath on rollers
- Pneumatic lowering unit
- Heating of oil quench bath
- Oil temperature display
- Charging floor grid and gas hood
- Holding unit for gas hood
- Manual protective gas unit see page 74
- Draw hook see page 77
- Safety equipment consisting of rim exhaust with flame trap and oil steam separator

Additional equipment

- Suction hood
- Water bath



Furnace Model	Tmax °C	Inner dimensions in mm			Volume in l	Outer dimensions in mm			Heating power in kW ²	Electrical connection*	Weight in kg
		w	d	h		W	D	H			
N 41/H ¹	1280	350	500	250	40	1040	1250	1340	15.0	3-phase	260

¹Furnace description see page 43

*Please see page 89 for more information about supply voltage

²Depending on furnace design connected load might be higher

Article no.	Protective gas hardening system	hood size in mm			Oil quench bath size in liters	max. load Weight	max. quench yield/h	Preflush rate	Process flush rate	Heating power oil bath/kW	Electrical connection*
		W	D	H							
-	SHS 41	260	360	180	400	25 kg	20 kg	20 - 25	10 - 15	6.0	3-phase
631006104	Gas hood (spare part)										

*Please see page 89 for more information about supply voltage

Gas Supply Systems

Protective Gases

Protective gases are used to force oxygen out of the gas feed boxes mentioned above. Make sure to use protective gases behaving neutrally toward the heat treated part. The protective gases should be inert, meaning no chemical bonding should occur with the workpiece or the furnace and no reactions should be induced.

In many cases, nitrogen is used as protective gas (lighter than air). Our experience shows that nitrogen does not always lead to sufficient results. A longer preflush time must also be used.

Better results are achieved by adding a mixture of nitrogen and adding some hydrogen. Hydrogen acts as a reducing constituent and reacts with the oxygen. This gas mixture is known as forming gas and available in stores. Experience has shown that adding 5 % hydrogen to the nitrogen leads to good results. According to the EU material safety data sheet this mixture is considered as not flammable. National regulations, however, must be observed. This gas can be obtained in premixed form. No measures must be taken in advance to prevent explosions.

If the workpiece has an affinity to hydrogen, argon used as protective gas can lead to good results.

Argon is a gas which is heavier than air. This makes it relatively easy to fill the protective gas containers. Forming gas with added hydrogen (depending on the country law up to a ration of 98/2) is lighter, but it has the advantage of burning at higher temperatures and therefore binds with the oxygen. Even in a cold state, the leaking hydrogen transports the oxygen very easily out of the container.

For gas mixtures with hydrogen or other combustible gases, the valid safety regulations must always be observed. If the mixture is declared as combustible, the furnace, provided it is a gas tight version, can be fitted with a corresponding safety system.

Always make sure that the room is properly ventilated when working with protective gases. Country-specific safety regulations must also be followed.



Manual Gas Feed Fitting for Bottles

- Pressure reducing valve with assembled flow meter and attached pressure gauge indicating the bottle pressure The assembled variable area flow meter ensures good readability of the amount used
- Connection: screw connection for bottle
- Exit: hose connection (inner diameter 9 mm)
- 200 bar intake pressure, 4 bar outlet pressure
- Incl. 4 m connecting hose to the furnace

Pressure reducing valve with assembled flow meter

Article no.	Type of gas	Flow rate l/min
631000309	Ar	0 - 30
631000310	N ₂	0 - 30
631000311	Non-flammable forming gas	0 - 30

Alternative connection threads on request

Gas Feed Fitting with Solenoid Valve

- Solenoid valve mounted on the furnace, controlled using the controller "Extra" function
- Connection: screw connection for bottle
- Exit: hose connection (inner diameter 9 mm)
- 200 bar intake pressure, 4 bar outlet pressure
- Incl. 4 m connecting hose to the furnace
- Available only in combination with furnace or switchgear



Article no.	Type of gas	Flow rate l/min
631000379	Ar	0 - 30
631000380	N ₂	0 - 30
631000381	Non-flammable forming gas	0 - 30

Alternative connection threads on request

Automatic Gas Supply System for two different Flushing Quantities, e.g. high Volume Pre-flushing and low Volume for ongoing Operation

Consisting of:

- Switching system with 3-step switch for gas inlet Off/Manual/Automatic via "Extra" function of respective controller, timer for switching from large gas quantity to small gas quantity. Gas feed stops at when program quits
- Automatic gas feed panel with pressure reducer, two adjustable flow meters and two solenoid valves, preinstalled conduit and wiring attached to furnace from the side on an assembly plate.
 - Connection: hose connection (inner diameter 9 mm)
 - Exit: hose connection (inner diameter 9 mm)
 - Max. 10 bar intake pressure, max. 300 mbar outlet pressure
 - Incl. connecting hose between furnace and protective gas box or gas connection
 - Available only in combination with furnace or switchgear



Automatic gas supply system for two flushing quantities

Article no.	Type of gas	Flow rate l/min
631000316	Ar	4 - 80
631000200	N ₂	4 - 80
631000315	Non-flammable forming gas	4 - 80

Vacuum Pump

Oil sealed rotary vane vacuum pump for universal use within the low vacuum range. Highly compact and low noise construction. Manometer included in delivery.

- Sliding vane rotary pump with sucking capacity of max. 16 m³/h
- 0,5 mbar absolute
- Connection hose made of stainless steel 2000 mm
- Connector KF16
- Manometer (-1/0.6 bar)



Vacuum pump

Article no.	Outer dimensions in mm			Connections on suction side		Connected load	Supply voltage*	Nominal suction power m ³ h	Suction capacity m ³ h-l
	W	D	H						
601403057	280	315	200	3/4"	1/2" inner thread	0.55 kW	230 V	16	15

*Article no. for other possible supply voltages on request

Gloves



Article no.: 491041101 491041104 491041103 493000004

- Specially insulated gloves for working with hot mechanical components and working near furnace

Article no.	Description	Short-time contact temperature in °C
491041101	Fiberglass finger glove, 380 mm long	approx. 700
491041102	Mitten, 280 mm long	approx. 400
491041103	Finger glove, 300 mm long	approx. 400
491041104	Fiberglass mitten, 380 mm long	approx. 700
493000004	Carbon-fiber finger glove, knitted	approx. 650

Heat-Resistant Face Mask



- Light design with adjustable hat size
- Plastic window, folds up

Article no.	Description
491037105	Heat-resistant face mask

Frontal Protection Coat

- Frontal heat protection
- Open back
- Velcro fastener on the back
- Material Preox-Aramid-Aluminium
- For radiated heat up to 1000 °C, max. 95 sec.
- C3-classification according to EN 11612-C
- Length 1300 mm

Article no.	Description
699000325	Frontal Protection Coat, Size 54 (D), 1300 mm

Draw Hook

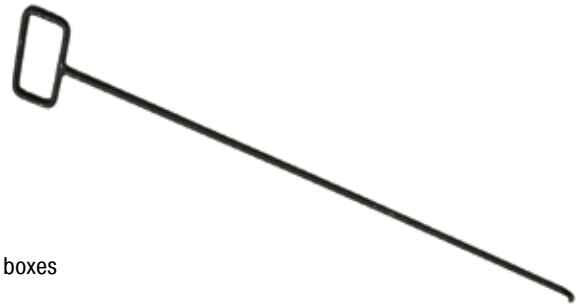

- For charging protective gas annealing bags with holder, annealing and protective gas boxes
- Large handle, also easy to handle with glove

Article no.	Length in mm
631000663	500
631000593	750
631000594	1000

Binding Wire

- For binding workpieces to allow easy removal from boxes
- Annealed twice and safe from breakage during charging



Article no.	Wire Ø in mm	Container
491036090	0.90	25 kg ring
491036125	1.20	25 kg ring
491036150	1.60	25 kg ring
491036200	2.00	25 kg ring
491036300	3.00	25 kg ring

Hardening Tongs

- Various shapes and sizes for different applications and workpiece geometries
- Handle length 600 mm, assuring sufficient distance from hot furnace chamber and for deep immersion length into quench bath

Article no.	Description
491003001	Tongs with flat jaw suitable for hand forming
491003002	Tongs with vertical mouth for lifting off floor
491003003	Tongs with bent mouth, universal use
491003004	Tongs with double-curve jaw, universal use
491003005	Half round tongs, for round rod materials
491003006	Knee tongs for larger rings with thick wall
491003008	Handy universal tongs for small parts (handle length 500 mm)

Article no.
491003001



491003002



491003005



491003006



Cooling Platforms for Models N 17/HR, N 61/H, N 161



Storage platforms are used for forced cooling of mechanical components or annealing boxes outside of the furnace. The platform can also be used for charging the box in front of the furnace.

- Fan with 25 m³/min ambient air

Article no.	Furnace	Outer dimensions in mm			Connected load kW	Supply voltage*	Comments
		W	D	H			
631000429	up to N 17/HR	550	610	760	0.2	230 V	The same as forced cooling system MHS 17 see page 71
631000529	up to N 61/H	335	1100	880 - 920	0.2	230 V	The same as CWK1 charging trolley see page 78
631000294	up to N 161	700	800	900	0.9	230 V	

*Article no. for other possible supply voltages on request

Charging Devices with and without Cooling Fan for Models N 31/H - N 641/13, N 30/45 HA - N 500/85 HA, LH (LF) 15/.. - LH (LF) 216/..



Charging cart CWK1

Charging Cart CW(K) 1, CW(K) 15 and CW(K) 16

For charging larger workpieces and annealing boxes.

- 4 casters, freely movable
- Equipped with a rack at working height for temporary storage
- Fixing lock for annealing bags (CWK)
- CWK version with cooling fan (0.2 kW, 230 V)

Article no.	Designation	Furnace	Outer dimensions in mm		
			W	D	H
631000528	CW 1	N 31/H, N 41..., N 61..., N 30/..HA, N 60/..HA	330	1100	880 - 920
631001320	CW 15	LH(LF) 15/.. - LH(LF) 60/..	370	1100	760 - 800
361001321	CW 16	LH(LF) 120/.. - LH(LF) 216/..	470	1000	760 - 800
631000529	CWK 1	N 31/H, N 41..., N 61..., N 30/..HA, N 60/..HA	330	1100	880 - 920
631001322	CWK 15	LH(LF) 15/.. - LH(LF) 60/..	370 + 100 ¹	1100	760 - 800
631001323	CWK 16	LH(LF) 120/.. - LH(LF) 216/..	470 + 80 ¹	1100	760 - 800

Art.-No. for NA 30/.. and NA 60/.. on request

¹ Side switch



Charging cart CW 2

Charging Cart CW 2 - CW 4 and CWK 2 - CWK 4

For charging larger workpieces and annealing boxes.

- 2 casters, 2 fixed rollers for heavy loads
- Equipped with a grid at working height for temporary storage
- Furnace locking via pedal lever
- CWK version with cooling fan (0,9 kW, 230 V)

Article no.	Designation	Furnace	Outer dimensions in mm		
			W	D	H
631000530	CW 2	N 81..., N 161..., N 120/..HA	500	1120	880 - 920
631000531	CW 3	N 321..	800	1490	880 - 920 ²
631000468	CW 4	N 641..	1040	1950	880 - 920 ²
631000469	CWK 2	N 81..., N 161..., N 120/..HA	500 + 80 ¹	1120	880 - 920
631000470	CWK 3	N 321..	800 + 80 ¹	1490	880 - 920 ²
631000471	CWK 4	N 641..	1040 + 80 ¹	1950	880 - 920 ²

Art.-No. for NA 120/.. on request

*Please see page 89 for more information about supply voltage

¹ Side switch

² Without holding grip

Charging Cart WS 81 and WS 12

For charging of protective gas and annealing boxes.

- 2 casters, 2 fixed rollers for heavy loads
- Parallel guided lift, approx. 20 mm
- Max. charging weight 80 kg
- Guiding track, mounted at the furnace base frame
- Guiding track and charging cart can be also ordered separately

Article no.	Designation	Furnace
631000473	WS 81	N 81..
631000695	WS 12	N 120/..HA

Art.-No. for NA 120/.. on request



Charging Stacker WS 81

Charging Stacker WS 25 - WS 321

- Lifting device with hand winch
- Compact construction with push bar and manual lifting device for easy and safe lifting
- 2 casters, 2 fixed rollers
- Adjustable loading fork width
- Max. charging weight 500 kg
- Guiding track, mounted at the furnace base frame
- Guiding track and forklift can be also ordered separately

Article no.	Designation	Furnace
631000425	WS 161	N 161..
631000370	WS 321	N 321..
631000299	WS 25	N 250/..HA
631000532	WS 50	N 500/..HA

Art.-No. for NA 250/.. and NA 500/.. on request



WS 50 charging stacker



Guiding track at the base frame

WS 641 Charging Stacker

Design as charging stacker WS 25 - WS 321, but

- Lifting device with manual hydraulic
- Max. charging weight 700 kg

Article no.	Designation	Furnace
631000426	WS 641	N 641..



Charging stacker WS 641 with chamber furnace N 641 and guiding track at the base frame

Quenching and Cleaning Baths

Baths for quenching in oil or water as well as for cleaning and degreasing are available as single or double baths and are made of stainless steel. Oil quench bath assure highly even cooling of workpieces and are equipped with a lid to immediately extinguish ignited oil. For optimal results, pre-tempering water baths for cleaning workpieces should have an appropriate degreasing additive mixed in to the water bath. An optional heating allows for a bath temperature of approx. 70 °C. All baths come with a charge carrier, supply and drain line.



Quenching bath Q 200 for quenching in oil or water

Article no.	Bath	Outer dimensions in mm			Volume in l	Quenchant performance in kg/h	max. load weight in kg
		W	D	H			
101300050	Q 50	350	350	700	50	5 - 10	20
101300040	Q 200	550	550	900	200	25 - 30	20

Article no.	Heating element (optional)	Connected load kW	Supply voltage*
631001014	Q 50	3	230 V
631001012	Q 200	6	400 V

*Article no. for other possible supply voltages on request

The oil and water quench baths are combined within a single housing and separated by a sheet metal wall in the Q 200 D, Q 400 D and Q 600 D combination baths. The oil quench bath is slightly preheated by the heated water bath. A splash pan is installed in front of the combination bath. Charging aids are available as additional equipment. The Q 200 D combination bath comes with a charge carrier, for models Q 400 D and Q 600 D must be ordered extra. For greater quenchant performance, the baths can be equipped with oil coolers.



Quenching bath Q 400 D with manual charging aid

Article no.	Bath	Outer dimensions in mm			Volume in l Oil/water	max. load weight in kg
		W	D	H		
101300100	Q 200 D	1200	700	900	200/125	20
101300200	Q 400 D	1700	750	900	400/300	40
101300300	Q 600 D	2100	900	900	600/450	60

Charging aid manual + electric	Total height in mm	Max. load weight in kg	Compressed air in bar	Connected load kW	Electrical connection ¹
Q 200 D	1800	20	6 - 9	-	-
Q 400 D	2480	40	-	0.3	1-phase
Q 600 D	2480	60	-	0.3	1-phase

Oil cooler	max. quenchant performance in kg/h	Connected load kW	Electrical connection ¹
Q 200 D	approx. 100	0.55	3-phase
Q 400 D	approx. 200	2.20	3-phase
Q 600 D	approx. 300	2.20	3-phase

¹Please see page 89 for more information about supply voltage



Oil cooler as additional equipment

Heating element	Connected load kW	Supply voltage*
Q 200 D	6	400 V
Q 400 D	9	400 V
Q 600 D	15	400 V

*Other supply voltages possible on request

Quench Tanks



Oil quenching bath OAB 67000 with heat exchanger and a volume of 67.000 liters oil

Subject to process, charge size and weight a customized quench bath will be designed and delivered. Standard sizes are also available. Water, oil or polymer are available as quenching medium.

Available quenching mediums:

- Water
- Oil
- Polymer

Design Specifications

- Powerful circulation of the quenching medium
- Controlled heating systems
- Lowering devices for the charge
- Fill-level control
- Automatic refill system in case of water as quenching medium
- Connection port for customer's cooling system
- Cooling system of the quenching medium via heat exchanger
- Oil separator for quench tanks with water
- Protective gas supply on the surface of oil quench tanks as fire protection
- Integration of bath temperature in the process control and documentation



Powerful circulation of quenching medium



Combined oil quenching and cleaning bath with immersible tables, protection cover, oil separator and exhaust system

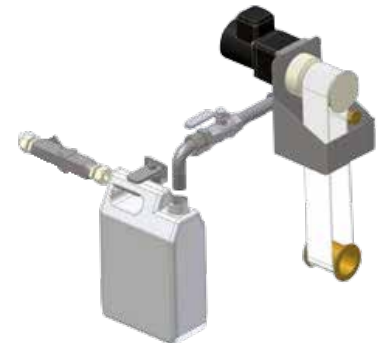

Oil separator for quench tanks with water



Hardening Oil



Hardening oil

- Suitable for most tooling steels
- Thermo-chemically stable and low misting
- Unlimited service life under normal use
- For mild quenching in critical martensite range
- Durixol W 25 w, can be cleaned using water

Article no.	Description	Container
491000140	Durixol W 25	50 l barrel
491000161	Durixol W 25	200 l barrel
491000240	Durixol W 25 w	50 l barrel

Quench Water Additive

- For even and rapid water hardening
- For water temperatures to 70 °C, thus reducing risk of cracks and deformation

Article no.	Description	Container
491050200	Hydrodur GF	50 kg sack

Detergent



Detergent in canister

- Cleaning additives increase the was time of the water and reduce costs
- Minimizes oil traces on workpieces and fumes during tempering

Article no.	Description	Container
493000016	Feroclean N-SF	10 kg canister
493000014	Feroclean N-SF	30 kg canister
493000017	Feroclean N-SF	50 kg barrel

Insulating Materials

- Formable ceramic-based paste to seal annealing boxes
- Also suitable for covering workpiece parts not requiring hardening

Article no.	Description	Container
491000120	Lenit heat-resistant putty	19 kg

Tailor-Made Furnace Plants

Various furnace families can be upgraded with protective gas boxes for processes under non-flammable protection or reaction gases.



Bogie hearth furnace with protective gas box

Forced convection bogie hearth furnace W 5290/85 AS with annealing box for heat treatment of coils under protective gas



Top hat furnace plant with three exchangeable tables and protective gas boxes for heat treatment with non-flammable protective or reaction gases



Air circulation chamber furnace N 250/65 HA IDB with protective gas box for inert debinding under protective gases incl thermal post combustion (TNV). Please also see catalog Advanced Materials.

Temperature Uniformity and System Accuracy

Temperature uniformity is defined as the maximum temperature deviation in the work space of the furnace. There is a general difference between the furnace chamber and the work space. The furnace chamber is the total volume available in the furnace. The work space is smaller than the furnace chamber and describes the volume which can be used for charging.



Holding frame for measurement of temperature uniformity

Specification of Temperature Uniformity in +/- K in the Standard Furnace

In the standard design the temperature uniformity is specified in +/- K at a defined set-temperature with the work space of the empty furnace during the dwell time. In order to make a temperature uniformity survey the furnace should be calibrated accordingly. As standard our furnaces are not calibrated upon delivery.

Calibration of the Temperature Uniformity in +/- K

If an absolute temperature uniformity at a reference temperature or at a defined reference temperature range is required, the furnace must be calibrated appropriately. If, for example, a temperature uniformity of +/- 5 K at a set temperature of 750 °C is required, it means that measured temperatures may range from a minimum of 745 °C to a maximum of 755 °C in the empty work space.

System Accuracy

Tolerances may occur not only in the work space, they also exist with respect to the thermocouple and in the controls. If an absolute temperature uniformity in +/- K at a defined set temperature or within a defined reference working temperature range is required, the following measures have to be taken:

- Measurement of total temperature deviation of the measurement line from the controls to the thermocouple
- Measurement of temperature uniformity within the work space at the reference temperature or within the reference temperature range
- If necessary, an offset is set at the controls to adjust the displayed temperature at the controller to the real temperature in the furnace
- Documentation of the measurement results in a protocol

Temperature Uniformity in the Work Space incl. Protocol

In standard furnaces, temperature uniformity is guaranteed as +/- K without measurement of temperature uniformity. However, as an additional feature, a temperature uniformity measurement at a target temperature in the work space compliant with DIN 17052-1 can be ordered. Depending on the furnace model, a holding frame which is equivalent in size to the work space is inserted into the furnace. This frame holds thermocouples at up to 11 defined measurement positions. The measurement of the temperature uniformity is performed at a target temperature specified by the customer after a static condition has been reached. If necessary, different target temperatures or a defined target working temperature range can also be calibrated.



Pluggable frame for measurement for forced convection chamber furnace N 7920/45 HAS

The system accuracy is defined by adding the tolerances of the controls, the thermocouple and the work space



Precision of the controls, e. g. +/- 1 K

Deviation of thermocouple, e. g. +/- 1.5 K

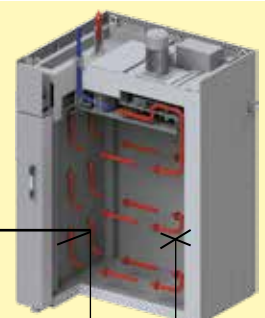

Deviation from measuring point to the average temperature in the work space e. g. +/- 3 K

AMS2750F, NADCAP, CQI-9

Standards such as the AMS2750F (Aerospace Material Specifications) are applicable for the industrial processing of high-quality materials. They define industry-specific requirements for heat treatment. Today, the AMS2750F and derivative standards such as AMS2770 for the heat treatment of aluminum are the guidelines for the aerospace industry. After the introduction of the CQI-9, the automotive industry has also committed to submit heat treatment processes to stricter rules. These standards describe in detail the requirements applicable to thermal processing plants.

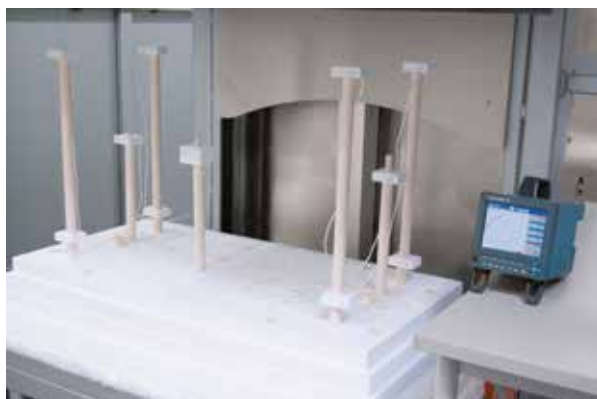

Measurement set-up in a high-temperature furnace

- Temperature uniformity in the work space (TUS)
- Instrumentation (definition of measurement and control systems)
- Calibration of the measurement system (IT) from the controller via the measurement line to the thermocouple
- Inspections of system accuracy (SAT)
- Documentation of the inspection cycles

Norm compliance is necessary to ensure that the required quality standard of the manufactured components can also be reproduced in series. For this reason, extensive and repeated inspections as well as controls of the instrumentation, including the relevant documentation, are required.

Furnace Class and Instrumentation Requirements of the AMS2750F

Depending on the quality requirements of heat treatment job the customer specifies instrumentation type and the temperature uniformity class. The instrumentation type describes the necessary combination of the applied control, recording media as well as thermocouples. The temperature uniformity of the furnace and the class of the selected instrumentation are defined based on the required furnace class. The higher the requirements are set for the furnace class the more precise the instrumentation must be.

Regular Inspections

The furnace or the heat treatment plant must be designed so that the requirements of the AMS2750F can be met and be reproduced. The standard also requires the inspection intervals for the instrumentation (SAT = System Accuracy Test) and the temperature uniformity of the furnace (TUS = Temperature Uniformity Survey). The SAT/TUS tests must be performed by the customer with measuring devices and sensors which operate independently of the furnace instrumentation.

Instrumentation	Type						Furnace class	Temperature uniformity	
	A	B	C	D+	D	E		°C	°F
Each control zone has a thermocouple connected to the controller	x	x	x	x	x	x	1	+/- 3	+/- 5
Recording of the temperature measured by the control thermocouple	x	x	x	x	x		2	+/- 6	+/- 10
Sensors for recording the coldest and hottest spots	x		x				3	+/- 8	+/- 15
Each control zone has a charge thermocouple with recording system	x	x					4	+/- 10	+/- 20
One additional recording sensor, distance ≥ 76 mm to control sensor, of a different sensor type				x			5	+/- 14	+/- 25
Each control zone has an over-temperature protection unit	x	x	x	x	x		6	+/- 28	+/- 50



Measurement set-up in an annealing furnace



Measuring protocol



Measurement range calibration

AMS2750F, NADCAP, CQI-9

The suitable furnace model for the corresponding heat treatment can be designed based on the process, the charge, the required furnace class and the type of instrumentation. Depending on the required specs, alternative solutions can be offered.



N 12012/26 HAS1 according to AMS2750F

- Furnace designs, which meet standards, following customer specifications regarding furnace class and instrumentation, incl. gauge connections for repeated customer inspections at regular intervals. No consideration of requirements with respect to documentation
- Data recording devices (e.g., temperature recorder) for TUS and/or SAT measurements see page 12
- Data recording, visualization, time management via the Nabertherm Control Center (NCC), based on Siemens WinCC software see page 13
- Commissioning at site, incl. the first TUS and SAT inspection
- Connection of existing furnace plant to meet norm requirements
- Documentation of the complete process chain in line with the corresponding norm

Implementation of AMS2750F

Basically, two different systems are available for control and documentation, a proven Nabertherm system solution or instrumentation using Eurotherm controllers/temperature recorders. The Nabertherm AMS package is a convenient solution that includes the Nabertherm Control Center for control, visualization, and documentation of the processes and test requirements based on PLC control.

Instrumentation with Nabertherm Control Center (NCC)

The attractive feature of the instrumentation with Nabertherm Control Center in combination with PLC controls of the furnace is the convenient data input and visualization. The software programming is structured in a way that both the user and the auditor can navigate it without difficulty.

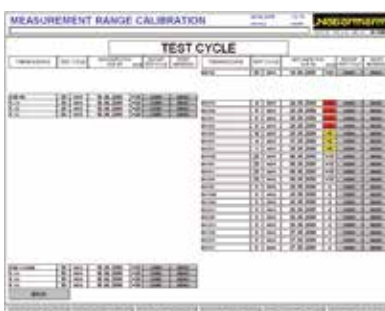
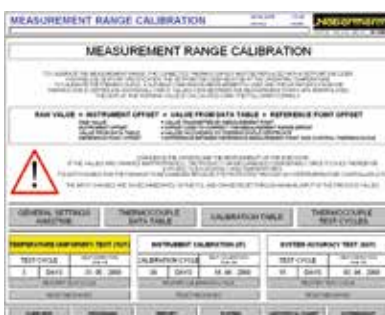

In daily use, the following product characteristics stand out:

- Very easy to navigate and straight-forward presentation of all the data in plain text on the PC
- Automatic saving of the charge documentation at the end of the program
- Administration of the calibration cycles in the NCC
- Results of the measurement distance calibration are entered in the NCC
- Schedule management of the required testing cycles including a reminder function. The testing cycles for TUS (Temperature Uniformity Survey) and SAT (System Accuracy Test) are entered in days and monitored by the system and the operator or tester is informed in time about up-coming tests. The measurements have to be done with separate calibrated measuring equipment.
- Option of transferring the measurement data to a customer's server

The Nabertherm Control Center can be extended to enable a complete documentation of the heat treatment process apart from just the furnace data. For example, when heat-treating aluminum, in addition to the furnace, the temperatures in the quenching basin or a separate cooling medium can also be documented.

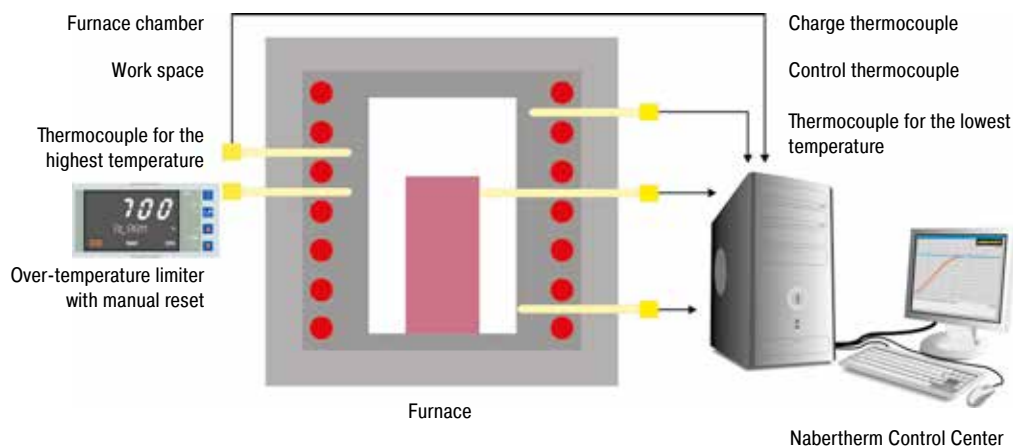

Example of a design with Type A Nabertherm Control Center

Alternative Instrumentation with Temperature Controllers and Recorders from Eurotherm

As an alternative to instrumentation with the Nabertherm Control Center (NCC) and PLC controls, instrumentation with controllers and temperature recorders is also available. The temperature recorder has a log function that must be configured manually. The data can be saved to a USB stick and be evaluated, formatted, and printed on a separate PC. Besides the temperature recorder, which is integrated into the standard instrumentation, a separate recorder for the TUS measurements is needed (see page 12).

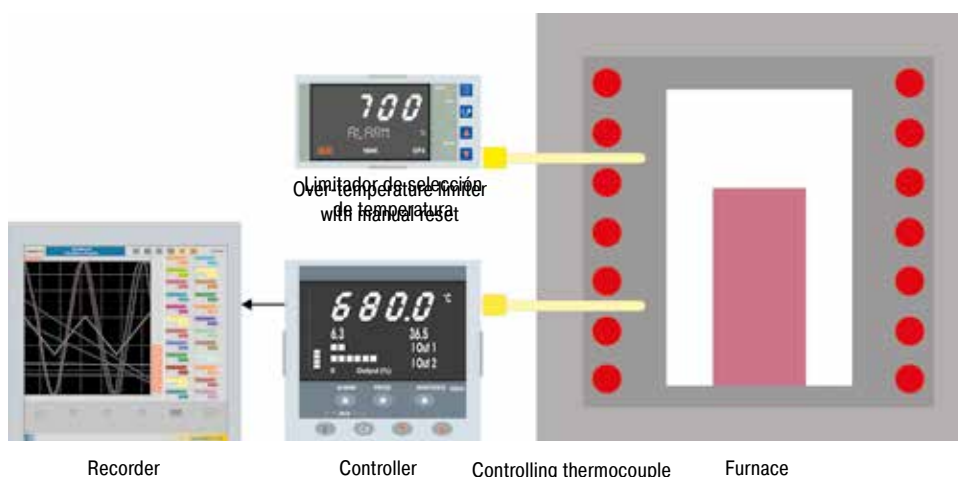

Example of a design containing Type D Eurotherm instrumentation

Furnace Chamber Control

Only the furnace chamber temperature is measured and controlled. Regulation is carried out slowly to avoid out-of-range values. As the charge temperature is not measured and controlled, it may vary a few degrees from the chamber temperature.

Charge Control

If the charge control is switched on, both the charge temperature and furnace chamber temperature are measured. By setting different parameters the heat-up and cooling processes can be individually adapted. This results in a more precise temperature control at the charge.

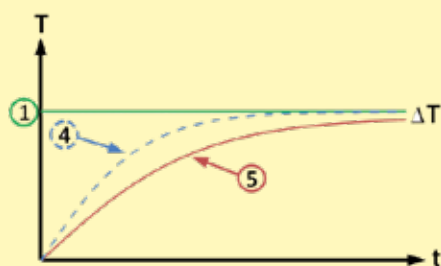

Furnace control

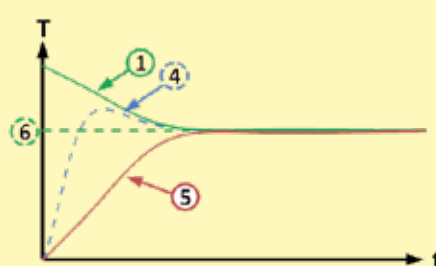

Charge control

1. Furnace setpoint value
2. Actual value furnace chamber, 1-zone
3. Actual value furnace chamber, 3-zone
4. Actual value furnace chamber
5. Actual value load/bath/muffle/retort
6. Charge setpoint value

Nabertherm Controller Series 500

**I AM THE
CONTROLLER**

I'm the big brother of analog buttons and turning switches. I am the new generation of control and intuitive operation. My skills are highly complex, my operation is simple. I can be touched and speak 24 languages. I'll show you exactly which program is currently running and when it ends.



The controller series 500 impresses with its unique scope of performance and intuitive operation. In combination with the free "MyNabertherm" smartphone app, the operation and monitoring of the furnace is even easier and more powerful than ever before. The operation and programming takes place via a high-contrast, large touch panel, which shows exactly the information that is relevant at the moment.



Standard Equipment

- Transparent, graphic display of the temperature curves
- Clear presentation of the process data
- 24 operating languages selectable
- Consistent, attractive design
- Easily understandable symbols for many functions
- Precise and accurate temperature control
- User levels
- Program status display with estimated end time and date
- Documentation of the process curves on USB storage medium in .csv file format
- Service information can be read out via USB stick
- Clear presentation
- Plain text display
- Configurable for all furnace families
- Can be parameterized for the different processes



Highlights

In addition to the well-known and matured controller functions, the new generation offers you some individual highlights. Here is an overview of the most important ones for you:

Modern Design

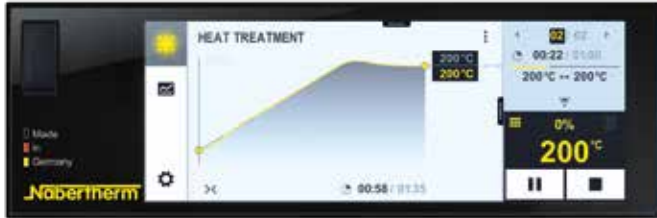

Colored display of temperature curves and process data

Easy Programming



Simple and intuitive program entry via touch panel

Integrated Help Function



Information on various commands in plain text

Program Management



Temperature programs can be saved as favorites and in categories

Segment Player



Detailed overview of process information including setpoint, actual value and switched functions

Wi-Fi-Capable



Connection with the MyNabertherm app



Intuitive touch screen



Easy program entry and control



Precise temperature control



User levels



Process documentation on USB

Further information on Nabertherm controllers, process documentation and tutorials on operation can be found on our website:
<https://nabertherm.com/en/series-500>



MyNabertherm App for Mobile Monitoring of Process Progress

MyNabertherm app – the powerful and free digital accessory for Nabertherm 500 Series Controllers. Use the app for convenient online progress monitoring of your Nabertherm furnaces – from your office, while on the way or from wherever you wish. The app always keeps you in the picture. Just like the controller itself, the app is also available in 24 languages.



Convenient monitoring of one or multiple Nabertherm furnaces simultaneously

App-Functions

- Convenient monitoring of one or multiple Nabertherm furnaces simultaneously
- Clear presentation as a dashboard
- Individual overview of a furnace
- Display of active/inactive furnaces
- Operating status
- Current process data

Display of Program Progress for Each Furnace

- Graphical representation of the program progress
- Display of furnace name, program name, segment information
- Display of start time, program run time, remaining run time
- Display of additional functions such as fresh-air fan, exhaust air flap, gassing, etc.
- Operating modes as symbol



Display of program progress for each furnace

Push Notifications in Case of Malfunctions and at Program End

- Push notification on the lock screen
- Display of malfunctions with an associated description in the individual overview and in a message list

Contact with Service Possible

- Stored furnace data facilitate rapid support for you

Requirements

- Connection of the furnace to the Internet via the customer's Wi-Fi
- For mobile devices with Android (from version 9) or IOS (from version 13)



Easy to contact



Monitoring of Nabertherm furnaces with 500 series touch panel controller for Arts & Crafts, laboratory, dental, thermal process technology, advanced materials and foundry applications.

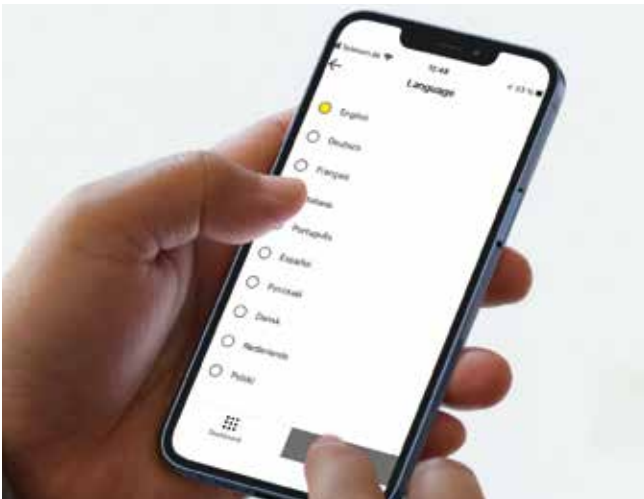

Available in 24 languages



Push notifications in case of malfunctions



Clear contextual menu



Any addition of Nabertherm furnaces

Everything on display in the new Nabertherm app for the new controller series 500. Get the most out of your furnace with our app for iOS and Android. Don't hesitate to download it now.



Functions of the Standard Controllers

	R7	3216	3208	B500/ B510	C540/ C550	P570/ P580	3508	3504	H500	H1700	H3700	NCC
Number of programs	1	1		5	10	50	1/10/ 25/50 ³	1/10/ 25/50 ³	20	20	20	100
Segments	1	8		4	20	40	500 ³	500 ³	20	20	20	20
Extra functions (e. g. fan or autom. flaps) maximum				2	2	2-6	0-4 ³	2-8 ³	3 ³	6/2 ³	8/2 ³	16/4 ³
Maximum number of control zones	1	1	1	1	1	3	2 ^{1,2}	2 ^{1,2}	1-3 ³	8	8	8
Drive of manual zone regulation				●	●	●						
Charge control/bath control						●	○	○	○	○	○	○
Auto tune		●	●	●	●	●	●	●				
Real-time clock				●	●	●			●	●	●	●
Graphic color display				●	●	●			4" 7"	7"	12"	22"
Graphic display of temperature curves (program sequence)												
Status messages in clear text			●	●	●	●	●	●	●	●	●	●
Data entry via touchpanel				●	●	●			●	●	●	●
Entering program names (i.e. "Sintering")				●	●	●				●	●	●
Keypad lock				●	●	●	○	○				
User levels				●	●	●	●	●	○	○	○	●
Skip-button for segment jump				●	●	●			●	●	●	●
Program entry in steps of 1 °C or 1 min.	●	●	●	●	●	●	●	●	●	●	●	●
Start time configurable (e. g. to use night power rates)				●	●	●			●	●	●	●
Switch-over °C/°F	○	○	○	●	●	●	○	○	●	● ³	● ³	● ³
kWh meter				●	●	●						
Operating hour counter				●	●	●			●	●	●	●
Set point output			○	●	●	●	○	○		○	○	○
NTLog Comfort for HiProSystems: recording of process data on an external storage medium									○	○	○	
NTLog Basic for Nabertherm controller: recording of process data with USB-flash drive				●	●	●						
Interface for VCD software				○	○	○	○	○				
Malfunction memory				●	●	●			●	●	●	●
Number of selectable languages				24	24	24						
Wi-Fi-capable („MyNabertherm" app)				●	●	●						

¹ Not for melt bath control

² Control of additional separate slave regulators possible

³ Depending on the design

● Standard
○ Option

Assignment of Standard Controllers to Furnace Families

	NR(A) 17/06 - NR(A) 1000/11	NR, NRA .. H ₂	NR, NRA .. IDB	NR, NRA 40/02 CDB	NR, NRA 150/02 CDB	SR(A) 17/06 - SR(A) 1500/11	VHT	VHT .. H ₂	LBVHT	SVHT	D 20/S - D 320/S	TS, TSB	QS	N 7/H - N 87/H	N 81(/..) - N 641(/..)	LH 15/12 - LF 120/14	NW	NA 15/65	NA 30/45 - N 500/85 HA	NA-I, NA-SI	SAL 30/45 - SAL 500/85	Q	Q .. D
Catalog page	16	18	18	21	21	22	26	30	31	32	36	39	41	43	43	54	58	61	61	65	66	80	80
Controller																							
C6/3208											●				○				○		○	○	○
3216																							
3504	○					○						●										○	○
B500																							
B510																		●					
C540													○										
C550																							
P570	●					●	● ³			● ³				○				○					
P580																		○					
H500/PLC																							
H700/PLC							● ³			● ³													
H1700/PLC			●	●		○						○											
H3700/PLC	○	●	●	●	●	○	○	●	○	○	○	○	○	○	○	○	○	○	○	○	○	○	○
NCC	○	○	○	○	○	○	○	○	○	○	○	○	○	○	○	○	○	○	○	○	○	○	○

Mains Voltages for Nabertherm Furnaces

1-phase: all furnaces are available for mains voltages from 110 V - 240 V at 50 or 60 Hz.

3-phase: all furnaces are available for mains voltages from 200 V - 240 V or 380 V - 480 V, at 50 or 60 Hz.

The connecting rates in the catalog refer to the standard furnace with 400 V (3/N/PE) respectively 230 V (1/N/PE).

Process Data Storage and Data Input via PC



There are various options for evaluation and data input the processes for optimal process documentation and data storage. The following options are suitable for data storage when using the standard controllers.

Data Storing of Nabertherm Controllers with NTLog Basic

NTLog Basic allows for recording of process data of the connected Nabertherm Controller (B500, B510, C540, C550, P570, P580) on a USB stick. The process documentation with NTLog Basic requires no additional thermocouples or sensors. Only data recorded which are available in the controller. The data stored on the USB stick (up to 130,000 data records, format CSV) can afterwards be evaluated on the PC either via NTGraph or a spreadsheet software used by the customer (e.g. Excel™ for MS Windows™). For protection against accidental data manipulation the generated data records contain checksums.

Visualization with NTGraph for MS Windows™ for Single-Zone Controlled Furnaces

The process data from NTLog can be visualized either using the customer's own spreadsheet program (e.g. Excel™ for MS Windows™) or NTGraph for MS Windows™ (Freeware). With NTGraph Nabertherm provides for an additional user-friendly tool free of charge for the visualization of the data generated by NTLog. Prerequisite for its use is the installation of the program Excel™ for MS Windows™ (from version 2003). After data import presentation as diagram, table or report can be chosen. The design (color, scaling, reference labels) can be adapted by using prepared sets. NTGraph is available in eight languages (DE/EN/FR/ES/IT/CN/RU/PT). In addition, selected texts can be generated in other languages.

Software NTEdit for MS Windows™ for Entering Programs on the PC

By using the software NTEdit for MS Windows™ (Freeware) the input of the programs becomes clearer and thus easier. The program can be entered on customers PC and then be imported into the controller (B500, B510, C540, C550, P570, P580) with a USB stick. The display of the set curve is tabular or graphical. The program import in NTEdit is also possible. With NTEdit Nabertherm provides a user-friendly free tool. A prerequisite for the use is the client installation of Excel™ for MS Windows™ (from version 2007). NTEdit is available in eight languages (DE/EN/FR/ES/IT/CN/RU/PT).



NTGraph, a freeware for the easy-to-read analysis of recorded data using Excel™ for MS Windows™



Recording of process data of the connected controller via USB stick



Process input via the NTEdit software (freeware) for MS Windows™

Process Data Storage

VCD-software for visualization, control and documentation

Documentation and reproducibility are more and more important for quality assurance. The powerful VCD software represents an optimal solution for single multi furnace systems as well as charge documentation on the basis of Nabertherm controllers.

The VCD software is used to record process data of the series 500 and series 400 as well as various further Nabertherm controllers. Up to 400 different heat treatment programs can be stored. The controllers are started and stopped via the software at a PC. The process is documented and archived accordingly. The data display can be carried-out in a diagram or as data table. Even a transfer of process data to Excel™ for MS Windows™ (.csv format *) or the generation of reports in PDF format is possible.



Example lay-out with 3 furnaces

Features

- Available for controllers series 500 - B500/B510/C540/C550/P570/P580, series 400 - B400/B410/C440/C450/P470/P480, Eurotherm 3504 and various further Nabertherm controllers
- Suitable for operating systems Microsoft Windows 7/8/10/11
- Simple installation
- Setting, Archiving and print of programs and graphics
- Operation of controllers via PC
- Archiving of process curves from up to 16 furnaces (also multi-zone controlled)
- Redundant saving of archives on a server drive
- Higher security level due to binary data storage
- Free input of charge date with comfortable search function
- Possibility to evaluate data, files exportable to Excel™ for MS Windows™
- Generation of a PDF-report
- 24 languages selectable

Extension Package 1 for display of an additional temperature measuring point, independant of the furnace controls

- Connection of an independent thermocouple, type S, N or K with temperature display on a supplied C6D display, e. g. for documentation of charge temperature
- Conversion and transmission of measured values to the VCD software
- For data evaluation, please see VCD-software features
- Display of measured temperature directly on the extension package

Extension Package 2 for the connection of up to three, six or nine measuring point, independant of the furnace controls

- Connection of three thermocouples, type K, S, N or B to the included connecting box
- Possible extension of up to two or three connecting boxes with up to nine measuring points
- Conversion and transmission of measured values to the VCD software
- Data evaluation, see VCD features



VCD Software for Control, Visualisation and Documentation



Graphic display of main overview (version with 4 furnaces)

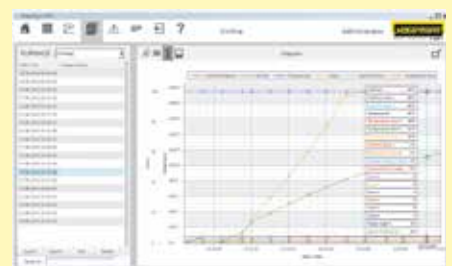

Graphic display of process curve

PLC Controls HiProSystems



This professional process control with PLC controls for single and multi-zone furnaces is based on Siemens hardware and can be adapted and upgraded extensively. HiProSystems control is used when process-dependent functions, such as exhaust air flaps, cooling fans, automatic movements, etc., have to be handled during a cycle, when furnaces with more than one zone have to be controlled, when special documentation of each batch is required and when remote service is required. It is flexible and is easily tailored to your process or documentation needs.

Alternative User Interfaces for HiProSystems

Process Control H500

This basic panel accommodates most basic needs and is very easy to use. Firing cycle data and the extra functions activated are clearly displayed in a table. Messages appear as text. Data can be stored on a USB stick using the „NTLog Comfort“ option.

Process Control H1700

Customized versions can be realized in addition to the scope of services of the H500. Display of basic data as online trend on a color 7" display with graphically structured interface.

Process Control H3700

Display of functions on a large 12" display. Display of basic data as online trend or as a graphical system overview. Scope as H1700.

Remote Maintenance Router – Fast Support in Case of a Malfunction

For fast failure diagnosis in case of a malfunction, remote maintenance systems are used for HiProSystems-plants (depending on the model). The plants are equipped with a router, which will be connected to the internet by the customer. In case of a malfunction, Nabertherm is able to get access to the furnace controls via a secured connection (VPN tunnel) and to perform a malfunction diagnosis. In most cases, the problem can be directly solved by e technician on site according with supervision from Nabertherm.

If no Internet connection can be provided, we offer optionally the remote maintenance via LTE network as additional equipment.



H1700 with colored, tabular depiction



H3700 with colored graphic presentation



Router for remote maintenance

Process Data Storage



The following options are available for industrial process documentation and the recording of data from several furnaces. These can be used to document the process data for the PLC controls.



NTLog Comfort for data recording of a Siemens PLC via USB stick

Data Storing of HiProSystems with NTLog Comfort

The extension module NTLog Comfort offers the same functionality of NTLog Basic module. Process data from a HiProSystems control are read out and stored in real time on a USB stick. The extension module NTLog Comfort can also be connected using an Ethernet connection to a computer in the same local network so that data can be written directly onto this computer.

Temperature Recorder

Besides the documentation via the software which is connected to the controls, Nabertherm offers different temperature recorders which can be used with respect to the application.

	Model 6100e	Model 6100a	Model 6180a
Data input using touch panel	x	x	x
Size of colour display in inch	5.5"	5.5"	12.1"
Number of thermocouple inputs	3	18	48
Data read-out via USB-stick	x	x	x
Input of charge data		x	x
Evaluation software included	x	x	x
Applicable for TUS-measurements acc. to AMS2750F			x

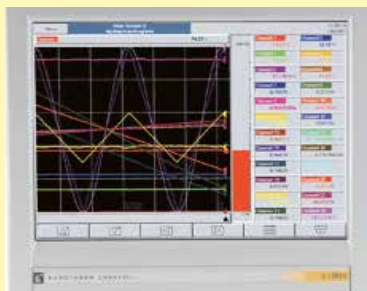

Temperature recorder

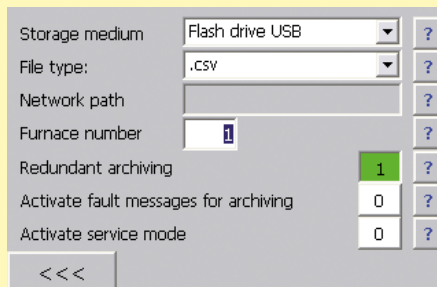

NTLog Comfort - Data recording via USB stick

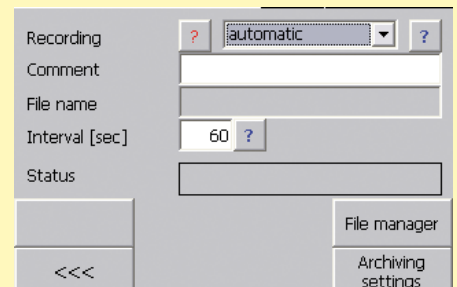

NTLog Comfort - Data recording online on the PC

Nabertherm Control Center NCC

PC-based control, process visualization and process documentation software

The Nabertherm Control Center as PC-supported furnace controls offers an ideal extension for furnaces with PLC based HiProSystem controls. The system has proven itself in many applications with increased demands on documentation and process reliability and also for convenient multi-furnace management. Many customers from the automotive, aviation, medical technology or technical ceramics sectors have been working successfully with this powerful software.



Retort furnace NR 300/08 for treatment in high vacuum

Standard Equipment

- Central furnace management
- Graphical furnace overview of up to 8 furnaces
- Tabular, clear program entry (100 program locations)
- Charge administration (article, quantity, additional information)
- Connection to the company network
- Adjustable access rights
- Online monitoring of the heat treatment
- Tamper-proof documentation
- Malfunction message list, adapted to the furnace model
- Archive function
- Delivery incl. PC and printer
- Measuring range calibration of up to 18 temperatures per measurement point. Multi-stage calibration is possible for applications with normative requirements.



Retort furnace NR 80/11 with IDB safety concept for debinding under non-flammable protective gases

Additional Equipment

- Reading in charge data via barcode
 - Simple data acquisition, ideal for frequently changing charges
 - Defined charge data ensures data quality
- Recipe storage with charge comparison
 - Comparison of charge and recipe to increase process reliability
- Adaptable access rights or access rights via employee cards
- Software extension to fulfill documentation requirements according to norms like AMS2750F (NADCAP), CQI9 or Food and Drug Administration (FDA), Part 11, EGV 1642/03
- Interface for connection to overriding systems
- SQL connection
- Redundant data storage
- Cellular connection or network connection for notification via SMS, e.g. in the event of malfunctions
- Control from different PC workstations
- Configuration as industrial PC or virtual machine
- PC cabinet
- UPS for PC
- Customization according to individual requirements



System overview



Furnace overview



Measurement range calibration

The whole World of Nabertherm: www.nabertherm.com

Please visit our website

www.nabertherm.com and find out all you want to know about us - and especially about our products.

Besides news and our current calendar of trade fairs, there is also the opportunity to get in touch directly with your local sales office or nearest dealer worldwide.

Professional Solutions for:

- Arts & Crafts
- Glass
- Advanced Materials
- Laboratory
- Dental
- Thermal Process Technology for Metals, Plastics and Surface Finishing
- Foundry



Headquarters:

Nabertherm GmbH

Bahnhofstr. 20
28865 Lilienthal, Germany
contact@nabertherm.de

Sales Organisation

China

Nabertherm Ltd. (Shanghai)
150 Lane, No. 158 Pingbei Road, Minhang District
201109 Shanghai, China
contact@nabertherm-cn.com

France

Nabertherm SARL
20, Rue du Cap Vert
21800 Quetigny, France
contact@nabertherm.fr

Italy

Nabertherm Italia
Via Trento N° 17
50139 Florence, Italy
contact@nabertherm.it

Great Britain

Nabertherm Ltd., United Kingdom
contact@nabertherm.com

Switzerland

Nabertherm Schweiz AG
Altgraben 31 Nord
4624 Härkingen, Switzerland
contact@nabertherm.ch

Spain

Nabertherm España
c/Marti i Julià, 8 Bajos 7ª
08940 Cornellà de Llobregat, Spain
contact@nabertherm.es

USA

Nabertherm Inc.
54 Read's Way
New Castle, DE 19720, USA
contact@nabertherm.com



All other Countries: Follow

<http://www.nabertherm.com/contacts>